

CAMBRO®



PRODUCT CATALOG
2018/19
www.cambro.com

CAMBRO® CATALOG TABLE OF CONTENTS

equipment



FOOD HOLDING & TRANSPORTATION

5

Cam GoBox®	6
Insulated Food Servers (Non-Electric)	12
Camchiller®, Thermobarrier® & Camwarmer®	14
Temperature Maintenance	15
Transporter Capacity Guide	16
Insulated Front Loaders	17
Ultra Camcarts®	20
Insulated Food Servers (Electric)	22
Insulated Beverage Containers	32
Beverage Service Cart	35
Camcarts® & Camcarriers®	36



WAREWASHING, HANDLING & STORAGE

61

Camrack® 4-in-1 System	62
Personalization	73
Camdollies®	75
Tray & Dish/Silver Cart	78
S-Series Adjustable	80
Dish Caddies	80
Cambox® Bus Boxes	84
KD Service Cart & KD Utility Cart	85
Service Carts	86
Sizing & Reference Guide	265



CAMSHELVING® ELEMENTS SERIES

114

Weight Bearing Chart	115
Elements Series Configurations	116
Elements Series Accessories	121



MOBILE VENDING

38

Versa Food Service System	39
Food Bar Accessories	42
Table Top Food Bars	43
Sample Food Bar Set-ups	44
CamKiosk® System	45
Hand Sink Cart	47
Camcruiser® Vending Carts	48
Flex Station	50
Booster Seats	51
Versa Organizers	51
Portable CamBars®	53
Ice Caddies	60



CAMSHELVING® PREMIUM SERIES

87

Key Features	90
Quick Reference Guide	92
Product Code Reference Guide	94
Free Camshelving Design Service	95
Overall Length — Quick Reference Guide	96
Camshelving Premium Series	98
Weight Bearing Chart	99
Premium Series Configurations	100
Premium Series Accessories	105
High Density Storage	
Floor Track System	111



CAMSHELVING® BASICS PLUS SERIES

126

Weight Bearing Chart	127
Basics Plus Series Configurations	128
Basics Plus Series Accessories	131
Wall Shelves and Shelf Extenders	134
Dunnage Racks	135
Camlink®	135

supplies



FOOD STORAGE AND PREPARATION

137

Quick Guide To Storage Solutions	138
Food Storage Containers	140
Food Storage Boxes & Lids	148
Camwear® Food Pans & Lids	152
X-Pans®	156
H-Pans™	158
Translucent Food Pans	163
ColdFest®	165
StoreSafe® Labels	166
Pizza Dough Boxes	167
Ingredient Bins & Camcrisper	168
Scoops & Measuring Cups	169



FOOD PRESENTATION

185

Deli Crocks & Platters	186
ShowFest® Display Bowls & Trays	187
Serving Bowls	188
Display Covers & Trays	191
Crocks & Ladles	192
Serving Spoons, Camtensils® & Turners	193
Tongs	194
Shakers/Dredges & Condiment Jars	195

healthcare



HEALTHCARE

242

Camduction®	
Complete Heat System	244
Meal Delivery Ware	247
Reusable CamLids® for Meal Delivery Systems	250
Camrack® Wash and Store Rack	250
Camshelving®	
Hygienic Drying Racks	252
Tablotherm	254
Versa Trays	258
Non-Slip Versa Trays	261
Camtrays® with Handles & Camwear Non-Slip Tray	262
Meal Delivery Carts	263



TABLE SERVICE

170

Dinnerware	171
Camcovers®	173
Personalization	174
Pitchers	175
Aliso® Barware	176
Cambro® Tumblers & Disposable CamLids®	177
Camliter®	182
Beverage Dispenser, Pail With Bail & Swirl Bowls®	183
Wine Buckets, Punch Bowls & Bud Vase	184



TRAYS

196

Tray Product Guide	198
Personalization	204
Polyester Versa Trays	206
Versa Lite Trays	212
Camtrays®	218
Dietary & Camlite® Trays	224
Camwear® Trays	225
Camtread® Trays	226
Treadlite™ & Polytread Trays®	227
EpicTread™ Trays	228
Wood Trays	228
Corfu, Mykonos, Capri, & Madeira Trays	230
Fast Food Trays	235
Compartment Trays	236
Market Trays & Pans	240

GENERAL INFORMATION

Icon Directory	3
Warranty	3
Alpha Numeric Listing	268
Roto Color Chart	281

PERSONALIZATION

CamKiosk®	46
Camcruisers®	49
Camracks®	73
Table Service/Storage Trays	174
	204

www.cambro.com

Visit www.cambro.com for a wide variety of information about our products including new product updates, an interactive Camrack Glass to Rack Guide, consultant cut sheets and CAD drawings, care and maintenance product guides and more.

The Trademarks of Cambro and product images are the property of Cambro and are subject to the control and ownership of Cambro. Any use thereof is only granted for the promotion and sales of Cambro products and subject to the control of Cambro Manufacturing Company.

the cambro® story

When William and Argyle Campbell first opened the doors at Cambro Manufacturing in 1951, their goal was to make a hospital meal tray of the highest quality possible. Named the Camtray®, it demonstrated that they were as committed to excellence in the food service industry as they were to the quality of their own products. As 2016 marks the company's 65th year of leadership in quality, innovation and customer service, today Cambro serves the world with the industry's most complete selection of products for widely diverse segments of the food service business.

Since 1951, the company has experienced many changes including a greatly expanded product line, new methods of manufacturing and distribution, and an increased emphasis on topics like environmental responsibility. From a single factory in California, Cambro has grown to become an international presence with production facilities and sales offices in the United States, Europe, the Middle East and Asia. But the original guiding vision of the Campbell brothers remains unchanged: to create and provide the most innovative, durable and highest quality products for the food service industry. Now led by William's son Argyle, Cambro is still dedicated to meeting our customers' needs, and equally committed to helping you serve, satisfy and delight your guests.

At the heart of our business philosophy is our willingness to listen, so in a very real way we owe all our success to you, our customer. Our longevity in a very competitive field for over 65 years certainly proves the value of that philosophy, and we are proud to have earned the loyalty of customers of all sizes and in all segments of the industry. From hotels to healthcare to caterers, from restaurant chains to educational facilities, we understand the food service business and we design and create our products with the end user foremost in mind. Our goal is to provide our customers the best

possible value on products that are durable, save labor and increase food safety, so you can offer your guests a superior experience while enhancing profitability.

Cambro is uniquely committed to investing in the people and processes that make our products a reality. We're proud that children and grandchildren of some of our first employees are with us today, and of the dedication to quality and service of our entire family worldwide. We continually work on developing new ideas for specific industry segments, and invest in new tooling and leading-edge machinery to bring these products to market. We persistently strive to improve our manufacturing methods to be more efficient in terms of process and materials, to keep costs under control while keeping our planet healthy. And we constantly seek to maintain quality and value despite rising costs of transport and raw materials, the need to reduce environmental impacts, and the demand of end users for total order accuracy and responsive service across a global market.

From once offering a single product, the Camtray, over sixty-five years ago, today Cambro offers a wide range of trays, table service and display items, storage, shelving, merchandising and insulated transport products, as well as innovative warewashing systems and healthcare meal delivery solutions.

The future is certain to bring great changes to our industry. Yet one thing that will remain a constant is Cambro's tradition of continually developing new products that help food service operators save time and money, increase sales, reduce labor and improve service. In the years ahead, guided by the commitment of its founders to innovation, quality, and value, Cambro Manufacturing will still be the leader in serving the food service industry and you, our valued customer.



CAMBRO® WARRANTY

- 5 year pro-rated warranty against damage or defects found in excess to normal wear and tear on
 - Camtrays®
 - Camtread Trays®
- 5 year warranty against breakage in excess to normal wear and tear
 - Versa Trays
 - Dinnerware
- 2 year warranty against breakage under normal use
 - Camwear® food storage pans
 - Camwear Squares
 - Camwear Rounds
 - Camwear Lids
- 1 year warranty on
 - Commercial Electric Equipment models
- 1 year warranty on workmanship and Lifetime Limited warranty against rust and corrosion, excluding mobile posts.
 - Camshelving®
 - Camshelving Elements Series

For all other Cambro products, Cambro warrants to the original buyer a three-year pro-rated warranty. If product proves defective during this time, Cambro grants a pro-rated credit of the original price toward replacement product. The warranty applies on all Cambro products only when used under normal foodservice industry conditions.

Specifications, features and equipment shown are based upon the latest information available. Cambro Manufacturing Company reserves the right to make changes at any time, without notice, to price, colors, specifications, accessories and materials. For additional information, please contact your authorized Cambro representative.

Note: Temperature ranges noted throughout this catalog are based on specific test criteria and provide a general guideline. Individual use may vary due to differences in loading temperatures or ambient temperature.

Product Accessories: Contents and accessories shown in photos are not included, except where noted.

ICON DIRECTORY

Throughout the Cambro catalog, find the following easy to identify icons to help explain Cambro product features or services.



Food Safety Matters

For 65+ years, Cambro foodservice equipment and supplies have earned the trust and loyalty of customers and public health professionals alike because our products are designed with Food Safety in mind. At Cambro, every product design is based upon the core principle of food safety.

Look for the Cambro StoreSafe mark throughout the Cambro catalog to identify Cambro storage and transportation products that support safe food handling.

You can learn more about Cambro's Food Safety initiatives at www.cambro.com/storesafe



Many Cambro products may be recycled. For further information, please contact your Cambro representative.



Listed by NSF International, an independent, not-for-profit organization which certifies products that meet their criteria for sanitation and cleanliness.



Foam Insulation



Cambro "Storage Select" BPA-Free (Bisphenol-A Free) products are available for customers who are interested in products deemed BPA-Free.

Please contact your sales representative for more information.



Not For Use In Heated Carts



Prorated Warranty



Fit for Food Products



Personalization Available
Non-Food Contact Areas Only



Certifies products by Technischer Überwachungs-Verein. (Technical Inspection Association)



Dishwasher Safe



One carton of product is within the weight and cube requirements to be shipped by parcel carrier.



New Product



Stackable



equipment

- INSULATED TRANSPORT**
- MERCHANDISING**
- WAREWASHING**
- CAMSHELVING®**



FOOD HOLDING AND TRANSPORTATION

Cam GoBox® – Insulated Lightweight Carrier Line

Insulated Top Loading Camcarriers®

Temperature Maintenance Tools

Transporter Capacity Guide

Insulated Front Loading UPC300

Insulated Front Loading UPC400

UPCS400 Ultra Pan Carrier® S-Series

Ultra Camcarts®

Ultra Pan Carrier® and Ultra Camcart® H-Series

Pro Cart Ultra™

Insulated Beverage Containers

Beverage Service Carts

Insulated Bakery Container

Camcarts®

Camcarriers®





CAM GOBOX® – INSULATED LIGHTWEIGHT CARRIERS

Cambro's latest line of insulated transporters are ideal for caterers and foodservice operators looking for an ultra-lightweight transporter that offers superior temperature retention to protect food safety and excellent durability to withstand heavy commercial use, all at a budget-friendly price. Just take them and go!

- Thermal Insulation – Holds hot or cold food for many hours.
- Lightweight – Made of EPP (Expanded Polypropylene) – an eco-friendly, high-performance foam material.
- Great Structural Strength – capable of handling significant loads while maintaining its shape and form.
- Excellent Energy Absorption – can withstand substantial impact without damage.
- Chemically Inert – unaffected by oil, grease, and most chemicals.
- Dishwasher safe.
- 100% Recyclable.
- Line your Cam GoBox with a Cambro GN Food Pan and Seal Cover for the ultimate food safety solution. Cambro GN pans protect food and carrier to support HACCP compliance.

Only available from Cambro European Logistics (CEL), Germany.

Note: Best results will be achieved by loading food pans between 82° to 88°C. Loading metal food pans over 120°C will result in damage to the carrier.



CAM GOBOX® – INSULATED LIGHTWEIGHT CARRIERS



Hot Holding

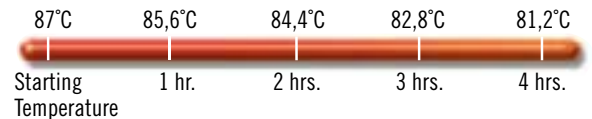

Cold Holding

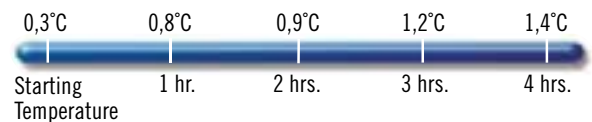

Using Cam GoBox carriers together with Cambro's Camwear®, polypropylene or high heat GN food pans creates the ideal food-safe, HACCP-compliant holding and transport system.



Ergonomic Handles

Comfortable handles allow easy and safe lifting of the Cam GoBox.



Stackability

Cam GoBoxes inter-stack and also stack with major competitive brands.



Easy Identification

A built-in label area keeps plastic menu tags (included for EPP300 and EPP400) in place for easy content identification or routing. StoreSafe Labels can also be used with Cam GoBoxes.



Easy Loading and Unloading

Interior wall recesses make loading and unloading easy for both GN 1/1 as well as 1/2 pans.



4-Sided Handling

Thoughtfully designed built-in handles along the top of the front loader units allow them to be easily carried from all four sides.

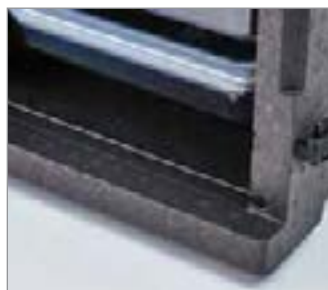

Drip-Resistant

Built-in condensation barrier helps front loaders to remain drip-resistant.



Gentle Open and Close

Beveled door edges ensure door can be easily closed and latched.



Full 270° Access

Durable hinges and latches allow the door to open 270° and remain open securely to the side of the front loader for easy access to products. Latches keep door securely closed during transport.

CAM GOBOX® GN – INSULATED LIGHTWEIGHT CARRIER TO TRANSPORT GN FOOD PAN



EPP260
 Top loader for 15 cm GN 1/2 pan
EXTERIOR DIM. L x W x H:
 39 x 33 x 25,7 cm
INTERIOR DIM. L x W x H:
 33 x 27 x 19,3 cm
UNIT WEIGHT: 0,62 kg
VOLUME: 16,9 L
Case Pack: 1 **Color:** Black (110).



EPP280
 Top loader for 20 cm GN 1/2 pan
EXTERIOR DIM. L x W x H:
 39 x 33 x 31,6 cm
INTERIOR DIM. L x W x H:
 33 x 27 x 25,3 cm
UNIT WEIGHT: 0,7 kg
VOLUME: 22,3 L
Case Pack: 1 **Color:** Black (110).

STOCK PRODUCTS & COLORS AVAILABLE IN OUR EUROPEAN WAREHOUSE

ALL CAM GOBOXES, EPP3253DIV: (110)
 CP2632, CP3253: (443)
 HP3253: (444)
 CD3253EPP: (158)
 EPPID5: (000)

Exclusive inter-stacking design saves

30%

storage space!



EPP180S
 Inter-stacking top loader for 20 cm GN 1/1 pan
EXTERIOR DIM. L x W x H:
 60 x 40 x 18,2 cm (top)
 58,6 x 33,6 x 10 cm (bottom)
INTERIOR DIM. L x W x H:
 53,8 x 33,8 x 15,9 cm (top)
 50,4 x 30,2 x 9,5 cm (bottom)
UNIT WEIGHT: 1,13 kg
VOLUME: 43 L
Case Pack: 1 **Color:** Black (110).



EPP160
 Top loader for 15 cm GN 1/1 pan
EXTERIOR DIM. L x W x H:
 60 x 40 x 25,7 cm
INTERIOR DIM. L x W x H:
 53,8 x 33,8 x 19,3 cm
UNIT WEIGHT: 1,07 kg
VOLUME: 35,5 L
Case Pack: 1 **Color:** Black (110).



EPP180
 Top loader for 20 cm GN 1/1 pan
EXTERIOR DIM. L x W x H:
 60 x 40 x 31,6 cm
INTERIOR DIM. L x W x H:
 53,8 x 33,8 x 25,3 cm
UNIT WEIGHT: 1,2 kg
VOLUME: 46 L
Case Pack: 1 **Color:** Black (110).



EPP180PKG
PACKAGE INCLUDES:
 EPP180 top loader
 18PP (20 cm polypropylene GN pan)
 10PPCWSC (Seal Cover)
UNIT WEIGHT: 2,8 kg
VOLUME: 46 L
Case Pack: 1 **Color:** Black (110).



EPP180SPKG
PACKAGE INCLUDES:
 EPP180S top loader
 18PP (20 cm polypropylene GN pan)
 10PPCWSC (Seal Cover)
UNIT WEIGHT: 2,7 kg
VOLUME: 43 L
Case Pack: 1 **Color:** Black (110).



EPP300
 Front loader for GN 1/1 pan
EXTERIOR DIM. L x W x H:
 64 x 44 x 47,5 cm
INTERIOR DIM. L x W x H:
 53,5 x 33 x 37 cm
UNIT WEIGHT: 3,2 kg
VOLUME: 60 L
Case Pack: 1 **Color:** Black (110).



EPP400
 Front loader for GN 1/1 pan
EXTERIOR DIM. L x W x H:
 64 x 44 x 62,5 cm
INTERIOR DIM. L x W x H:
 53,5 x 33 x 52,5 cm
UNIT WEIGHT: 3,9 kg
VOLUME: 86 L
Case Pack: 1 **Color:** Black (110).



EPPMD4835
 Lunch box
EXTERIOR DIM. L x W x H:
 48,5 x 35 x 16,5 cm
UNIT WEIGHT: 0,4 kg
Case Pack: 1 **Color:** Blue (159).

Optional Accessories



CP2632
 Camchiller® GN 1/2 cold plate
DIMENSIONS L x W x H:
 32,5 x 26,5 x 3,1 cm
UNIT WEIGHT: 1,75 kg
Case Pack: 1 **Color:** Glacier Blue (443).



CP3253*
 Camchiller® GN 1/1 cold plate
DIMENSIONS L x W x H:
 53 x 32,5 x 3 cm
UNIT WEIGHT: 3,9 kg
Case Pack: 1 **Color:** Glacier Blue (443).



HP3253*
 Camwarmer® GN 1/1 hot plate
DIMENSIONS L x W x H:
 53 x 32,5 x 3 cm
UNIT WEIGHT: 3,25 kg
Case Pack: 1 **Color:** Fire Red (444).



EPP3253DIV
 ThermoBarrier® fits EPP300 and EPP400
DIMENSIONS L x W x H:
 53 x 32,7 x 3,7 cm
UNIT WEIGHT: 0,37 kg
Case Pack: 1 **Color:** Black (110).



CD3253EPP
 Camdolly® fits GN 1/1 Cam GoBoxes
UNIT WEIGHT: 4,5 kg
Case Pack: 1 **Color:** Hot Red (158).



EPPID5
 Plastic ID labels fits all Cam GoBoxes
Case Pack: 1 **Color:** (000).

*Suitable for all front loader of UPC Series.

CAM GOBOX® CAPACITY GUIDE

All Cam GoBox carriers are designed with enough room to hold GN 1/2 and 1/1 pans along with Camwarmers® or Camchillers®, if desired.

Top Loaders

EPP260 GN 1/2 and EPP160 GN 1/1

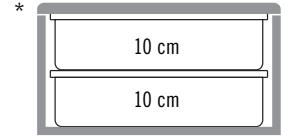
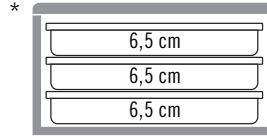
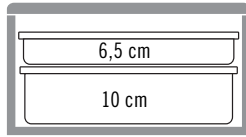
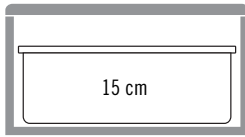

EPP280 GN 1/2 and EPP180 GN 1/1

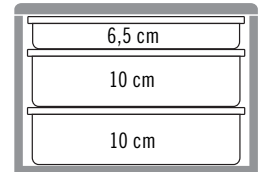
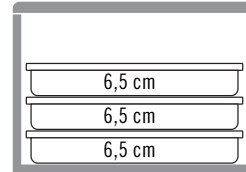
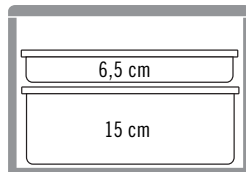
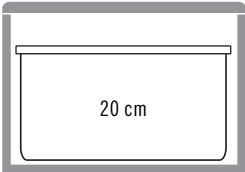

EPP180S GN 1/1

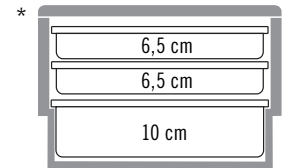
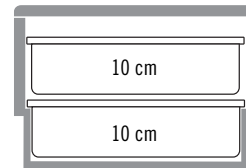
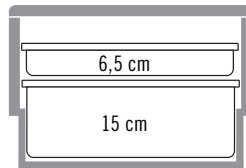
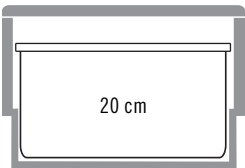

Front Loaders

*Indicates use without temperature maintenance tools.

EPP300 GN 1/1

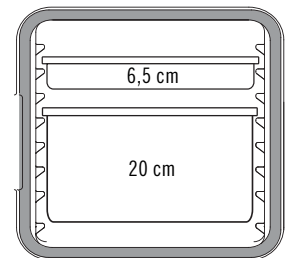
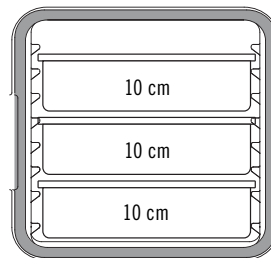
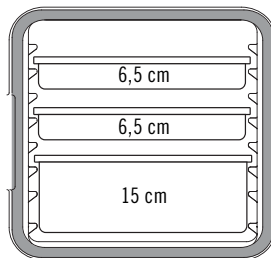
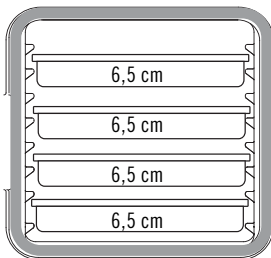

EPP400 GN 1/1

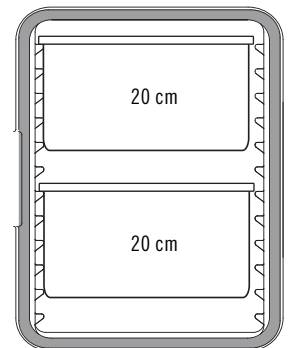
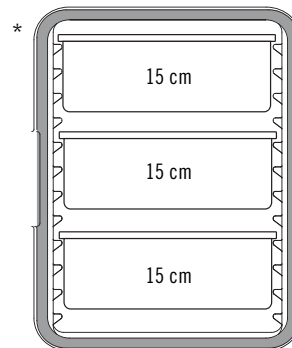
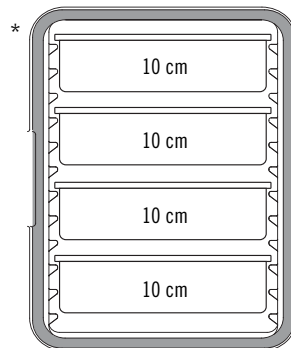
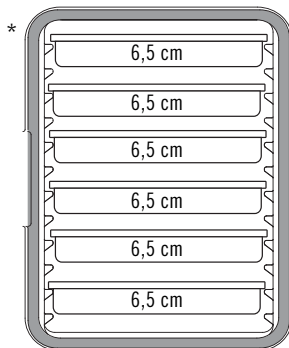

Food Pan Capacity Guide

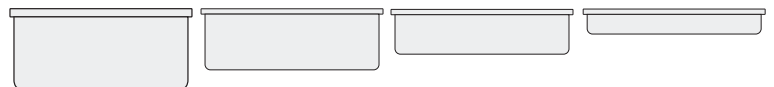

GN 1/1 Food Pan

DEPTH	20 cm	15 cm	10 cm	6,5 cm
SERVING CAPACITY PER PAN	25,5 L	19,5 L	13 L	8,5 L

CAM GOBOX® 4060 – INSULATED LIGHTWEIGHT CARRIER TO TRANSPORT



60 X 40 CM BAKERY BASKETS, SHEET PANS AND TRAYS

Multi-purpose Front-Loader can be modified from a non-molded in rail carrier to a versatile unit by installing optional, stainless steel adjustable rails for transporting a combination of 60 x 40 cm crates, baking pans and trays, all in the same carrier.



EPP4060FNR



EPP4060FADJR
(EPP4060FNR + EPP4060FPR1)



EPP4060FPR1



Additional rails
sold separately.



Baking pans and baskets not
available through Cambro®.



EPP4060FNR



EPP4060FNR



EPP4060FADJR



EPP4060FADJR



EPP4060FADJR

CAM GOBOX® 4060 – INSULATED LIGHTWEIGHT CARRIER TO TRANSPORT 60 X 40 CM BAKERY BASKETS, SHEET PANS AND TRAYS

Optional Accessories

New!



EPP4060FADJR

Front loader with adjustable rails (EPP4060FNR + kit of 2 frames and 4 adjustable stainless steel rails)

EXTERIOR DIM. L x W x H:
77 x 54 x 68,7 cm

INTERIOR DIM. L x W x H:
61,5 x 41 x 58,5 cm

UNIT WEIGHT: 8,17 kg

VOLUME: 155 L

Case Pack: 1 **Color:** Black (110).



EPP4060FNR

Front loader without rail

EXTERIOR DIM. L x W x H:
77 x 54 x 68,7 cm

INTERIOR DIM. L x W x H:
61,5 x 41 x 58,5 cm

UNIT WEIGHT: 6,1 kg

VOLUME: 155 L

Case Pack: 1 **Color:** Black (110).



EPP4060F6R

Front loader with 6 rails

EXTERIOR DIM. L x W x H:
77 x 54 x 68,7 cm

INTERIOR DIM. L x W x H:
61,5 x 41 x 58,5 cm

UNIT WEIGHT: 6,34 kg

VOLUME: 126 L

Case Pack: 1 **Color:** Black (110).



EPP4060FPR1

Kit of 4 Stainless steel rails + 2 Frames for EPP4060FNR

DIMENSIONS L x W x H: 60 x 1 x 58 cm

UNIT WEIGHT: 2,07 kg

Case Pack: 1 **Color:** Silver (000).

EPP4060FAR

Kit of 2 Stainless steel rails for EPP4060FPR1

DIMENSIONS L x H: 60 x 3 x 3 cm

UNIT WEIGHT: 0,42 kg

Case Pack: 1 **Color:** Silver (000).



EPP4060F9R

Front loader with 9 rails

EXTERIOR DIM. L x W x H:
77 x 54 x 68,7 cm

INTERIOR DIM. L x W x H:
61,5 x 41 x 58,5 cm

UNIT WEIGHT: 6,6 kg

VOLUME: 126 L

Case Pack: 1 **Color:** Black (110).



EPP4060T200

Top loader, 20 cm deep

EXTERIOR DIM. L x W x H:
49 x 69 x 27 cm

INTERIOR DIM. L x W x H:
42,5 x 62,5 x 20,5 cm

UNIT WEIGHT: 1,4 kg

VOLUME: 53 L

Case Pack: 1 **Color:** Black (110).



EPP4060T300

Top loader, 30 cm deep

EXTERIOR DIM. L x W x H:
49 x 69 x 37 cm

INTERIOR DIM. L x W x H:
42,5 x 62,5 x 30,5 cm

UNIT WEIGHT: 1,7 kg

VOLUME: 80 L

Case Pack: 1 **Color:** Black (110).



HP3253

Camwarmer® GN 1/1 hot plate

DIMENSIONS L x W x H:
53 x 32,5 x 3 cm

UNIT WEIGHT: 3,25 kg

Case Pack: 1 **Color:** Fire Red (444).



CP3253

Camchiller® GN 1/1 cold plate

DIMENSIONS L x W x H:
53 x 32,5 x 3 cm

UNIT WEIGHT: 3,9 kg

Case Pack: 1 **Color:** Glacier Blue (443).



CD4060EPP

Camdolly® for 60 x 40 Cam GoBoxes

DIMENSIONS L x W x H:
71 x 51 x 16 cm

UNIT WEIGHT: 5,27 kg

Case Pack: 1 **Color:** Hot Red (158).

Note: Best results will be achieved by loading food pans between 82° to 88°C. Loading metal bakery pans over 120°C will result in damage to the carrier.



Only available from Cambro European Logistics (CEL), Germany.

STOCK PRODUCTS & COLORS AVAILABLE IN OUR EUROPEAN WAREHOUSE

ALL CAM GOBOXES: (110)
CP3253: (443)
HP3253: (444)
CD4060EPP: (158)
EPPID5: (000)

INSULATED TOP LOADING CAMCARRIERS® TO TRANSPORT GASTRONORM FOOD PANS



- Top-loading food pan carriers hold, transport and serve a single full-size pan of hot or cold food.
- Sturdy and durable, seamless polyethylene or polypropylene with thick foam insulation.
- Molded-in handles on all four sides for easy carrying and handling.
- Use with divider bars to hold multiple fractional pans.
- Pans are easy to remove using finger notches.
- Carriers interlock and stack for transporting and storing.

UPCS Colors: Dark Brown (131), Coffee Beige (157), Speckled Grey (480), Black (110).

MPC and MPCHL Colors: Navy Blue (186), Slate Blue (401), Coffee Beige (157), Dark Brown (131), Brick Red (402), Green (519), Black (110), Hot Red (158).

UPC Colors: Slate Blue (401), Dark Brown (131), Black (110), Granite Grey (191), Granite Green (192).

Camdolly® Colors: Coffee Beige (157), Dark Brown (131), Black (110), Slate Blue (401), Grey (180).

Divider Bar Colors: White (148), Clear (135).

See Food Pan Section for pricing and ordering information.

Note: Place food pans on rails. Pans should not be placed on the floor of a Camcarrier® cavity.

Note: Best results will be achieved by loading food pans between 82° to 88°C. Loading metal food pans over 121°C may result in damage to the carrier.



UPC140



No divider bars available for UPC100.

UPC160

Shown with dividers and fractional sized food pans.

Hot

UPC160	87°C	85°C	83°C	81°C	79°C
UPCS160	87°C	85°C	83°C	81°C	79°C
UPCSS160	87°C	85°C	83°C	81°C	79°C

Starting Temperature 1 hr. 2 hrs. 3 hrs. 4 hrs.

Cold

UPC160	0°C	1°C	2°C	2°C	2,5°C
UPCS160	0°C	1°C	2°C	2°C	2,5°C
UPCSS160	0°C	1°C	2°C	2°C	2,5°C

Starting Temperature 1 hr. 2 hrs. 3 hrs. 4 hrs.

Camcarrier®

One-piece, seamless polyethylene construction, airtight removable gasket and sturdy plastic latches.



CODE	240MPC
COMPARTMENT CAPACITY	1 GN 1/2 – 10 cm deep pan
EXTERIOR DIMENSIONS W x D x H	42 x 35 x 19 cm
Case Pack:	1 240MPC No Divider Bar.

S-Series

Durable polypropylene construction, built in seal and wide, nylon latches.
Contemporary appearance and superior holding performance at an economical price.

STOCK PRODUCTS & COLORS AVAILABLE IN OUR EUROPEAN WAREHOUSE

UPCS180: (480)



CODE	UPCS140	UPCS160*	UPCS180
COMPARTMENT CAPACITY	1 GN 1/1 – 10 cm deep pan	1 GN 1/1 – 15 cm deep pan	1 GN 1/1 – 20 cm deep pan
EXTERIOR DIM. W x D x H	64 x 43,5 x 22 cm	64 x 43,5 x 26 cm	64 x 43,5 x 30,5 cm
FITS CAMDOLLY®	CD160	CD160	CD160

Case Pack: 1 *UPCS160 Cannot be used with Camchiller.

Ultra Pan

One-piece, seamless polyethylene construction, airtight removable gasket and wide, nylon latches.



CODE	UPC140	UPC160	UPC180
COMPARTMENT CAPACITY	1 GN 1/1 – 10 cm deep pan	1 GN 1/1 – 15 cm deep pan	1 GN 1/1 – 20 cm deep pan
EXTERIOR DIM. W x D x H	63 x 44 x 21 cm	63 x 44 x 26 cm	63 x 44 x 30,5 cm
FITS CAMDOLLY	CD100H, CD1826HB, CD160	CD100H, CD1826HB, CD160	CD100H, CD1826HB, CD160

Case Pack: 1

100 Series

Store and stack food pans or place food directly in compartment. The 100MPCHL model has a hinged serving lid.



CODE	100MPC	100MPCHL	UPC100
COMPARTMENT CAPACITY	3 GN 1/1 – 6,5 cm deep pan or 2 GN 1/1 – 10 cm deep pans or 1 GN 1/1 – 15 or 20 cm deep pan	1 GN 1/1 – 20 cm deep pan	3 GN 1/1 – 6,5 cm deep pans or 2 GN 1/1 – 10 cm deep pans or 1 GN 1/1 – 15 cm or 20 cm deep pan
EXTERIOR DIM.	68 x 45 x 38 cm	68 x 45 x 39,5 cm	68 x 46 x 40 cm
INTERIOR DIM. W x D x H	55 x 35 x 20,5 cm	55 x 35 x 20,5 cm	56,5 x 33 x 20,5 cm
BULK CAPACITY*	38 L	38 L	38 L
FITS CAMDOLLY	CD100H, CD1826MTC, CD100HB, CD1826MTCHB, CD100, CD2028	CD100, CD100H, CD100HB	CD100H, CD1826MTC, CD100HB, CD1826MTCHB, CD100, CD2028

Case Pack: 1 *Without using food pans. 100MPC, 100MPCHL and UPC100 No Divider Bar.

Accessories

CODE	DIMENSIONS	CASE PACK
Divider Bars for Food Pans		
DIV12	32,38 cm length	3
DIV20	53,02	3

*Not for use in UPCSS1600.



CAMCHILLER®, THERMOBARRIER® AND CAMWARMER®



Camchiller

- An easy-to-use, cold food holding temperature tool.
- Extend cold holding time or enhance safe holding below 5°C when frequent access is required.
- Freeze first then use to pre-chill cabinet before loading.

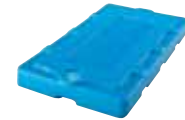
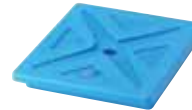
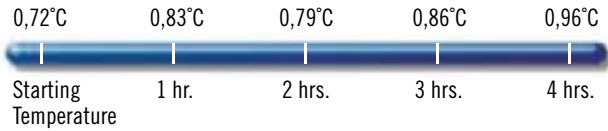

CODE	CP1220 (GN FULL SIZE)	CP1210 (GN HALF SIZE)	CP814 (20 x 36 CAMCHILLER)
FITS INTO	UPCSS160, UPC300, 300MPC, 1318CC, 1318MTC, UPC400, UPC400SP, UPSC400, UPC600, UPC800, UPC800SP, UPC1200, UPC1600, CVC72, CVC724, all Combo Cart® Plus and CamKiosk®*	UPC300, 300MPC, 1318CC, 1318MTC, UPC400, UPSC400, UPC400SP, UPC600, UPC800, UPC800SP, UPSC140, UPSC160, UPSC180, CVC724*, CVC72* and all CamKiosks*	12186CW, 12186P, 12189CW, 12189P, CVC724, CVC72, CVC55, and all CamKiosks*
DIMENSIONS L x W x H	53 x 33 x 3,8 cm	32,4 x 26,4 x 3,8 cm	35,56 x 20,32 x 3,8 cm
QUANTITY PER CAVITY	1 (*2 per cavity)	1 (*2 per top wells)	1

Case Pack: 1 Color: Cold Blue (159).

ThermoBarrier

- A highly valuable yet economical temperature maintenance tool for caterers.
- Use to minimize empty space and food temperature loss within a partially loaded compartment.



STOCK PRODUCTS & COLORS AVAILABLE IN OUR EUROPEAN WAREHOUSE

400DIV: (180)

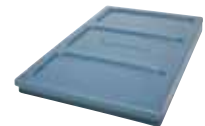
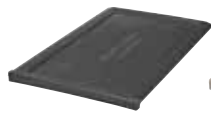

CODE	UPC300DIV ^{New!}	300DIV	400DIV	1200DIV	1600DIV
FITS INTO	UPC300, 1318CC	300MPC, 1318MTC, UPC600	UPC400, UPC800, UPC400SP, UPSC400, UPC800SP	UPC1200, CVC72, CVC724	UPC1600, CamKiosk, UPC1600SP
DIMENSIONS L x W x H	53 x 33 x 2,5 cm	53 x 33 x 2,5 cm	54 x 33 x 3,8 cm	53 x 33,5 x 3,5 cm	53 x 33,5 x 3,8 cm
COLOR	Charcoal Gray (615)	Coffee Beige (157)	Grey (180)	Dark Brown (131)	Slate Blue (401)
CASE PACK	1	1	1	2	2

Camwarmer

- Use for added insurance to keep hot foods hot during holding and transporting.
- Keep in cabinet with hot foods to extend holding time or enhance safe holding above 65°C when frequent access is required.



CODE	1210PW
FITS INTO	UPC300, 300MPC, 1318CC, 1318MTC, UPC400, UPSC400, UPC600, UPC800
DIMENSIONS L x W x H	34 x 27,5 x 4 cm
CASE PACK	1

Color: Granite Grey (191).

UPC400 with Camwarmer.
Two Camwarmers recommended per cavity.

STOCK PRODUCTS & COLORS AVAILABLE IN OUR EUROPEAN WAREHOUSE

1210PW: (191)

TEMPERATURE MAINTENANCE – OPTIMIZE FOOD HOLDING PERFORMANCE

Camchiller® – GN 1/1 Size and GN 1/2 Size

- Use to:
 - Pre-chill cabinet cavity.
 - Hold package food in food pan wells. (Half Size Only)
 - Maximize cold food holding.
 - Minimize open cavity space.
- Easy to use:
 1. Freeze 8 hours.
 2. Slide one or two on top rails and pre-chill cavity 15-20 minutes.
 3. Load in pans of pre-chilled food below Camchiller. (A)
 4. Move pans and Camchiller down as food is removed. (B)

COLD HOLDING

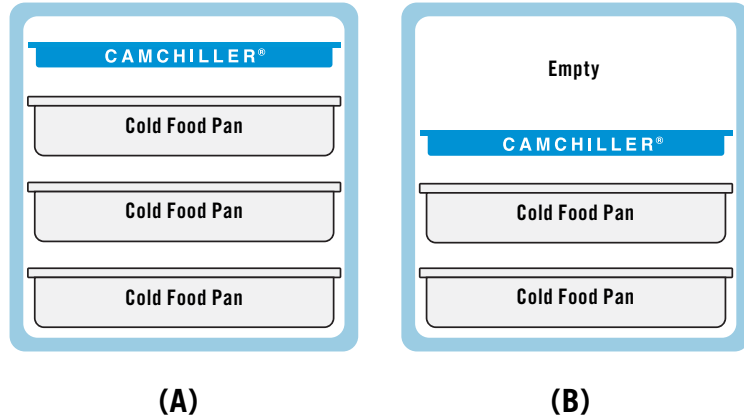

ThermoBarrier® – GN 1/1 Size

- Use to:
 - Hold hot and cold food in same cabinet cavity.
 - Minimize open cavity space.
- Easy to use:
 1. Slide between hot food on top and cold food on bottom. (A)
 2. Slide under hot food loaded in upper cavity space. (B)
 3. Slide above cold food loaded into lower cavity space. (C)

HOT AND COLD HOLDING

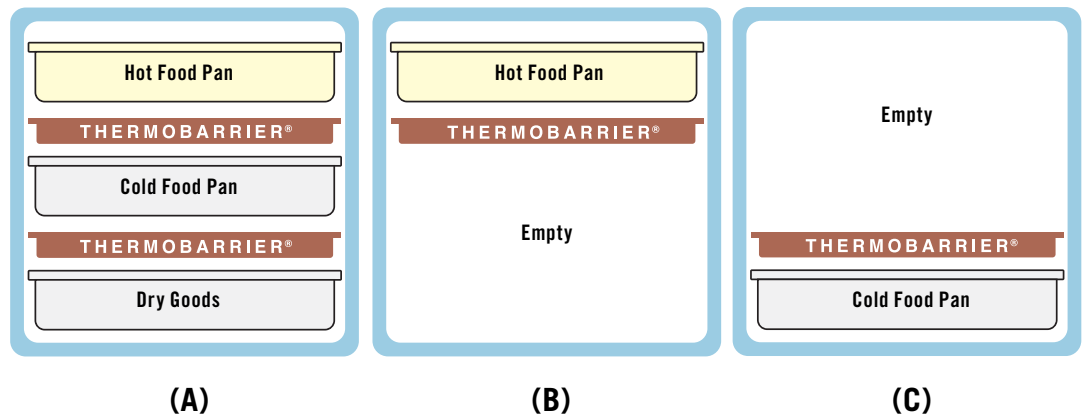

Camwarmer® – GN 1/2 Size

- Use to:
 - Pre-heat cabinet cavity.
 - Maximize hot food holding.
 - Minimize open cavity space.
- Easy to use:
 1. Heat in 180°C oven for 45 minutes.
 2. Slide two Camwarmers on bottom rails and pre-heat cavity 15-20 minutes. (or place on high heat food pan lid or sheet pan)
 3. Load in pans of pre-heated food above Camwarmers. (A)
 4. Move pans and Camwarmers up as food is removed. (B)

HOT HOLDING

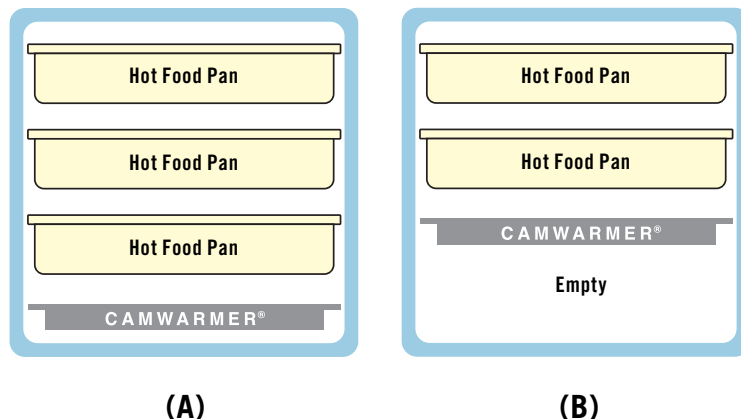

TRANSPORTER CAPACITY GUIDE

Loading Examples for Cambro® Insulated Transporters

TOP LOADERS

UPC140-UPC180
UPCS140-UPCS180
UPCSS160

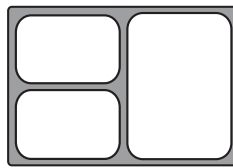
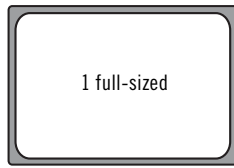

For a 3-course meal:
2 x GN 1/4
1 x GN 1/2
1 DIV12 divider bar
(approx. 14 meals)

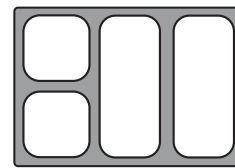

For a 4-course meal:
2 x GN 1/6
2 x GN 1/3
2 DIV12 divider bars
(approx. 14 meals)

TOP LOADERS

100 series
100MPC
UPC100

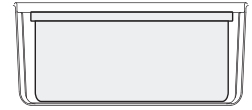
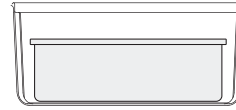
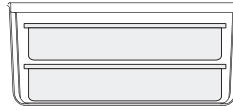
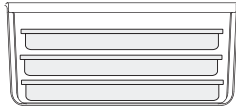

FRONT LOADERS

UPC300
1318CC
UPC600 (x2)
UPC1200 (x4)

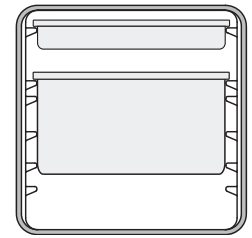
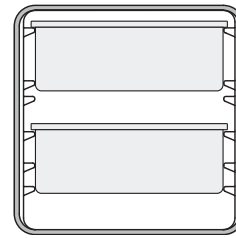
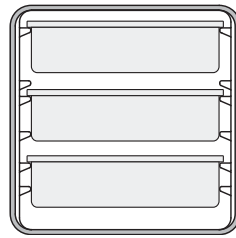
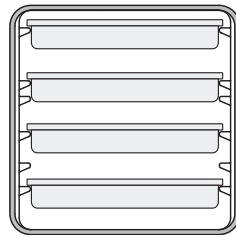

FRONT LOADERS

UPC400
UPCS400
UPCH400(2)
UPC800 (x2)
UPCH800(2) (x2)
UPC1600 (x4)
UPCH1600(2) (x4)

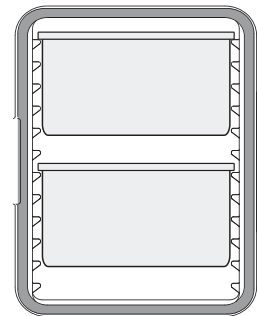
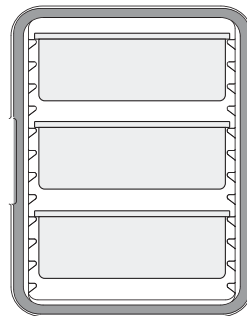
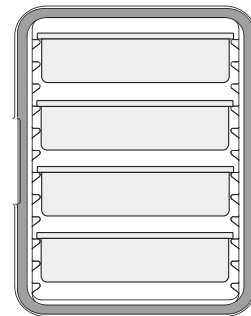
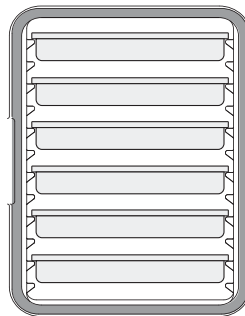

CAMCARRIERS® AND CAMCARTS® FOR SHEET PANS

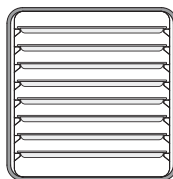

1318CC
1/2 size (x8)
sheet pans

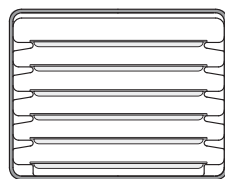

1826MTC
full-size (x6)
sheet pans
1826DTC (x4)

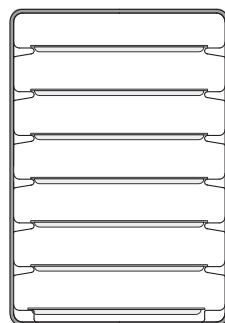

1826LTC3
full-size (x7)
sheet pans

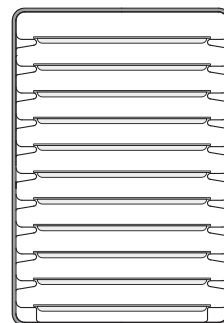

Camtherm Low
full-size (x11)
sheet pans
Camtherm Tall (x2)

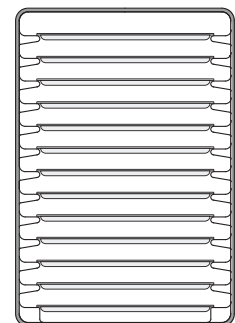

1826LTC
full-size (x13)
sheet pans

SUMMARY OF GN CONTAINER SIZES

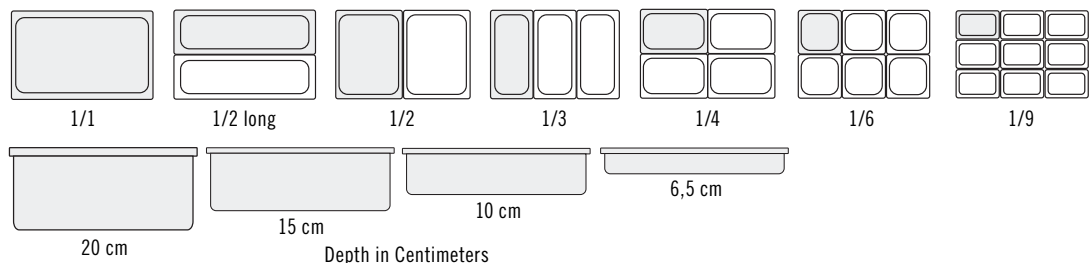

INSULATED FRONT LOADING UPC300 TO TRANSPORT GASTRONORM FOOD PANS

- Holds full-size GN 1/1, GN 1/2 and GN 1/3 pans.
- One-piece seamless construction for great durability.
- Thick polyurethane insulation safely keeps cold food below 4°C, hot food above 64°C for 4+ hours.
- Fully removable, gasketless door.
- Labeling area on door for adhering ID or routing labels.
- Light weight.

Colors: Black (110), Dark Brown (131), Hot Red (158), Navy Blue (186), Slate Blue (401), Charcoal Gray (615).

UPC300 is covered by US Patent D786,607 S.



STOCK PRODUCTS & COLORS AVAILABLE IN OUR EUROPEAN WAREHOUSE

UPC300: (401)
CP3253: (443)
HP3253: (444)



New!



Recommended labeling with: 23SLINB250 5 x 7,6 cm StoreSafe® Labels.

CODE	UPC300
EXTERIOR DIM. W x D x H	43,2 x 65,4 x 56,8 cm
INTERIOR DIM. W* x D x H	33,7 x 53,3 x 35,5 cm
UNIT WEIGHT	10,5 kg

Case Pack: 1 *Rail to Rail.

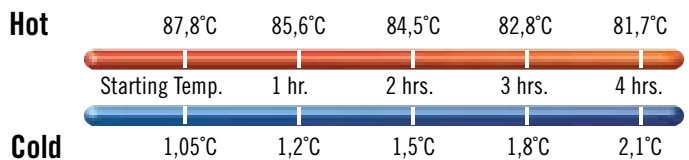

Optional Accessories

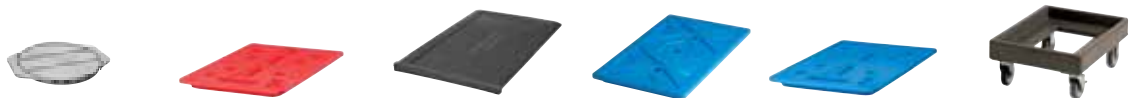

CODE	1210PW	HP3253	UPC300DIV <i>New!</i>	CP1220	CP3253	CD300*
DESCRIPTION	Camwarmer®	Camwarmer	ThermoBarrier®	Camchiller®	Camchiller	Camdolly®
EXTERIOR DIM. (CM)	34,9 x 27,6 x 4	53 x 32,5 x 3	53 x 33 x 2,5	53 x 33 x 3,8	53 x 32,5 x 3	49 x 65 x 26,5
INTERIOR DIM. (CM)	—	—	—	—	—	43 x 59
COLOR	Granite Grey (191)	Fire Red (444)	Charcoal Gray (615)	Cold Blue (159)	Glacier Blue (443)	▲

Case Pack: 1 *Also available CD300H and CD300HB. See Camdolly section. ▲Camdolly Colors: Slate Blue (401), Coffee Beige (157), Dark Brown (131), Black (110).



INSULATED FRONT LOADING UPC400 TO TRANSPORT GASTRONORM FOOD PANS

- Durable and dependable front-loading food pan carriers.
- Hold multiple pans of hot or cold food at safe temperatures for hours.
- Seamless polyethylene with thick foam insulation.
- Airtight removable gasket provides a secure seal.

Colors: Navy Blue (186), Slate Blue (401), Coffee Beige (157), Dark Brown (131), Black (110), Granite Grey (191), Granite Green (192), Granite Sand (194).

Note: Place food pans on rails. Pans should not be placed on the floor of a Camcarrier® cavity. Please use specified food pan sizes.

See Food Pan section for pricing and ordering information.

Note: Best results will be achieved by loading food pans between 82° to 88°C. Loading metal food pans over 121°C may result in damage to the carrier or cart.

UPC400 is covered by US Patent D 392,158.

Venting plug is covered by US Patent D 553,717 S.



HOLDING CAPACITY:

Pan Depth	Number of GN 1/1 pans
6,5 cm	6
10	4
15	3
20	2

Also holds GN 1/2 and 1/3 size pans.

STOCK PRODUCTS & COLORS AVAILABLE IN OUR EUROPEAN WAREHOUSE

UPC400, CD400: (401)
400DIV: (180)
CP3253: (443)
HP3253: (444)

ERGONOMIC DESIGN

Unbreakable, ergonomic, molded-in handles for comfortable two-person carrying.



PRESSURE AND HUMIDITY CONTROL

Pop-up vent.



TEMPERATURE RETENTION

Polyurethane insulation keeps hot food hot and cold food cold.



QUICK ACCESS

Single, 23 cm nylon latch for quick and secure opening and closing.

REMOVABLE GASKET

Provides an airtight seal.

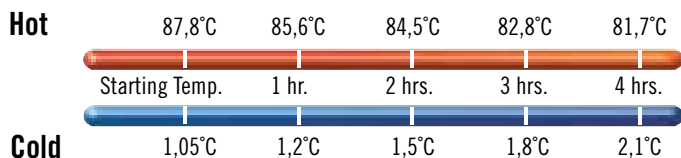

CODE	UPC400 (UPC400SP**)
EXTERIOR DIM. W x D x H	42,5 x 62 x 57 cm
INTERIOR DIM. W* x D x H	34 x 53,5 x 36 cm
UNIT WEIGHT	14,3 kg (16,33 kg)

Case Pack: 1 *Rail to Rail. **Security Package (SP) Model.

Optional Accessories

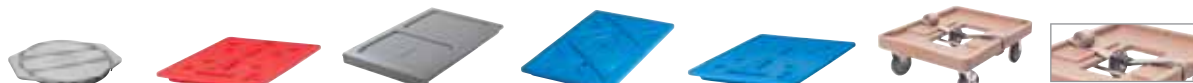

CODE	1210PW	HP3253	400DIV	CP1220	CP3253	CD400	400STP
DESCRIPTION	Camwarmer®	Camwarmer	ThermoBarrier®	Camchiller®	Camchiller	Camdolly®	Strap
EXTERIOR DIM. (CM)	34,9 x 27,6 x 4	53 x 32,5 x 3	54 x 33 x 3,8	53 x 33 x 3,8	53 x 32,5 x 3	71 x 53 x 23	500 cm long
INTERIOR DIM. (CM)	—	—	—	—	—	63,5 x 46	—
COLOR	Granite Grey (191)	Fire Red (444)	Grey (180)	Cold Blue (159)	Glacier Blue (443)	▲	Beige (000)

Case Pack: 1 ▲CD400 Colors: Coffee Beige (157), Dark Brown (131), Black (110), Slate Blue (401).

UPCS400 ULTRA PAN CARRIER® S-SERIES TO TRANSPORT GASTRONORM FOOD PANS

- Ultra dependable, ultra durable front-loading pan carrier.
- Holds multiple pans of hot or cold food for hours.
- Durable polyethylene shell and thick, polyurethane foam insulation.

Colors: Slate Blue (401), Speckled Grey (480), Dark Brown (131).

Note: Best results will be achieved by loading food pans between 82° to 88°C. Loading metal food pans over 121°C may result in damage to the carrier or cart.



HOLDING CAPACITY:

Pan Depth	Number of GN 1/1 pans
6,5 cm	6
10	4
15	3
20	2

Also holds GN 1/2 and 1/3 size pans.



Stacks with both UPCS400. Fits on CD400 Camdolly, or optional casters may be added for smooth ground transport.

STOCK PRODUCTS & COLORS AVAILABLE IN OUR EUROPEAN WAREHOUSE

UPCS400: (480), (401), **CD400:** (401)
400DIV: (180), **CP3253:** (443), **HP3253:** (444)

EASY CONTENT AND ROUTING LABELING
Menu clip reduces need to open door.



CONVENIENT
Integrated pan-staging area eases service (not for use during transport).

EASY TO CLEAN
Door removes for easy cleaning.



TEMPERATURE RETENTION
Polyurethane insulation keeps hot food hot and cold food cold.



ERGONOMIC DESIGN
Unbreakable, ergonomic, molded-in handles for comfortable two-person carrying.

QUICK ACCESS
Single, 23 cm nylon latch for quick and secure opening and closing.



BUILT-IN SEAL
Built-in seal eliminates need for removable gasket.

PRESSURE CONTROL
Built-in vent equalizes pressure and releases steam.

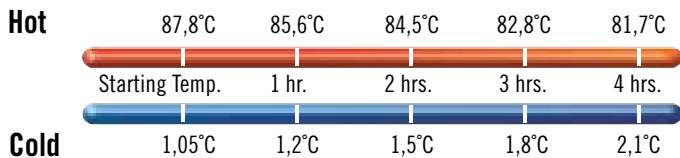

CODE	UPCS400
EXTERIOR DIM. W x D x H	63,5 x 46 x 63 cm
INTERIOR DIM. W x D x H	53,5 x 33,5 x 48,6 cm
UNIT WEIGHT	21,1 kg
Case Pack: 1	

Optional Accessories

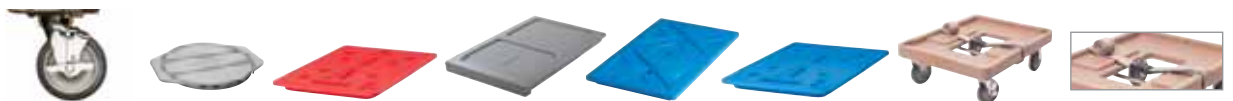

CODE	UPCS400CK	1210PW	HP3253	400DIV	CP1220	CP3253	CD400	400STP
DESCRIPTION	Caster Kit*	Camwarmer®	Camwarmer	ThermoBarrier®	Camchiller®	Camchiller	Camdolly®	Strap
EXTERIOR DIM. (CM)	∅ 12,7	34,9 x 27,6 x 4	53 x 32,5 x 3	54 x 33 x 3,8	53 x 33 x 3,8	53 x 32,5 x 3	71 x 53 x 23	500 cm long
INTERIOR DIM. (CM)	—	—	—	—	—	—	63,5 x 46	—
COLOR	—	Granite Grey (191)	Fire Red (444)	Grey (180)	Cold Blue (159)	Glacier Blue (443)	▲	Beige (000)

Case Pack: 1 *Optional Caster Kit for UPCS400: 2 fixed, 2 swivel, 1 w/ brake. ▲CD400 Colors: Coffee Beige (157), Dark Brown (131), Black (110), Slate Blue (401).

ULTRA CAMCARTS® TO TRANSPORT GASTRONORM FOOD PANS



- Double-compartment, high-capacity carts hold and transport hot or cold food.
- Tough, polyethylene shell and thick foam insulation throughout cabinet and between compartments.
- Airtight removable gaskets maintain safe food temperatures for hours.
- Easy to maintain and won't dent, crack, rust, chip or break.
- Durable nylon door latches open easily and close securely.
- Full-swing doors open to the side of the cart for easy loading and unloading.
- Molded-in handles ensure easy maneuvering.
- Molded-in bumpers minimize damage to walls, furniture and other equipment.

Colors: Navy Blue (186), Slate Blue (401), Coffee Beige (157), Dark Brown (131), Brick Red (402), Green (519), Black (110), Hot Red (158), Granite Grey (191), Granite Green (192), Granite Sand (194).

Note: Place food pans on rails. Pans should not be placed on the floor of a Camcart cavity. Please use specified food pan sizes.

Note: Best results will be achieved by loading food pans between 82° to 88°C. Loading metal food pans over 121°C may result in damage to the carrier or cart.

Venting plug is covered by US Patent D 553,717 S.



Polyurethane insulation keeps hot food hot and cold food cold.



Shown with optional HD casters.

Security Package (SP)

Specially designed for operations where safety and security are a top priority.

- Tamper resistant fasteners.
- Non-removable doors.
- Lockable hasp on each door (padlocks not included).
- Heavy duty (HD) casters with chassis plates mounted with tamper resistant bolts.

Marine rail is designed for use during service, not transport.



TOTAL CART HOLDING CAPACITY	UPC600	UPC800	UPC1200	UPC1600
Full Size Food Pans				
6,5 cm deep	8 pans	12 pans	16 pans	24 pans
10 cm deep	6 pans	8 pans	12 pans	16 pans
15 cm deep	4 pans	6 pans	8 pans	12 pans
20 cm deep	2 pans + 2 each 10 cm pans	4 pans	4 pans	8 pans
Camtray®*				
3253	12 trays	24 trays	24 trays	48 trays
2632	24 trays	48 trays	—	—
2025	—	—	12 trays	24 trays

See Food Pan and Camtray Section for ordering information.
*Based on 3,8 cm spacing between trays.

Hot

UPC600	86,8°C	84,3°C	82,5°C	80,8°C	79,3°C
UPC800	87,7°C	85,5°C	84,2°C	82,9°C	81,7°C
UPC1200	85,6°C	82,1°C	80,1°C	78,3°C	77,2°C
UPC1600	87,1°C	85,9°C	85,1°C	84,3°C	83,7°C

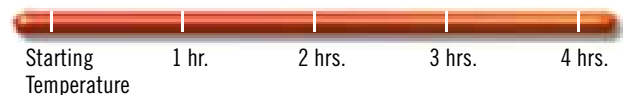

Cold

UPC600	0,6°C	1,1°C	1,4°C	1,8°C	2,1°C
UPC800	0,3°C	0,8°C	0,9°C	1,2°C	1,4°C
UPC1200	0,5°C	0,9°C	1,1°C	1,3°C	1,4°C
UPC1600	0,6°C	1,0°C	1,2°C	1,5°C	1,5°C





UPC600

CODE	UPC600
DESCRIPTION	Base model
EXTERIOR DIM. W x D x H	52 x 69 x 114,5 cm
COMPARTMENT DIM.	34 x 54 x 35,5 cm
Case Pack: 1 Casters: 12,7 cm, 2 fixed, 2 swivel, 1 with brake.	



UPC800

CODE	UPC800	UPC800SP
DESCRIPTION	Base model	Security package
EXTERIOR DIM. W x D x H	52 x 69 x 137 cm	52 x 69 x 137 cm
COMPARTMENT DIM.	33 x 54,5 x 48,5 cm	33 x 54,5 x 48,5 cm
Case Pack: 1 Casters: 15,2 cm, 2 fixed, 2 swivel, 1 with brake.		
Heavy Duty (HD) Casters: 15,2 x 3,8 cm, 2 fixed, 2 swivel with brake casters.		



UPC1200

CODE	UPC1200
DESCRIPTION	Base model
EXTERIOR DIM. W x D x H	72,5 x 82 x 116 cm
COMPARTMENT DIM.	54 x 66,5 x 34,5 cm
Case Pack: 1 Casters: 15,2 cm, 2 fixed, 2 swivel, 1 with brake.	



UPC1600

CODE	UPC1600	UPC1600HD	UPC1600SP*	UPCGL1600SP*
DESCRIPTION	Base model	Base model with HD casters	Security package	Security package, gasketless
EXTERIOR DIM. W x D x H	71,5 x 82 x 135 cm	73 x 84,7 x 138,4 cm	71,5 x 82 x 135 cm	71,5 x 82 x 135 cm
COMPARTMENT DIM.	53,5 x 66,5 x 53,5 cm	53,5 x 66,5 x 53,5 cm	53,5 x 66,5 x 53,5 cm	53,5 x 66,5 x 53,5 cm
Case Pack: 1 Casters: 15,2 cm, 2 fixed, 2 swivel, 1 with brake. Heavy Duty (HD) Casters: 15,2 x 5,08 cm 2 fixed, 2 swivel with brake casters.				
<i>*Security Package (SP) have lock-in hinge pins and latches and wheels are attached with tamper resistant screws.</i>				



STOCK PRODUCTS & COLORS AVAILABLE IN OUR EUROPEAN WAREHOUSE

UPC1200, UPC600: (401), UPC800: (401), (192), (194)
400DIV: (180), CP3253: (443), HP3253: (444)

Optional Accessories

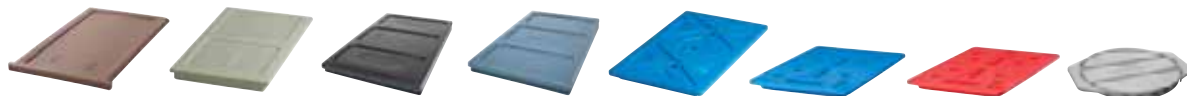

CODE	300DIV	400DIV	1200DIV	1600DIV	CP1220	CP3253	HP3253	1210PW
DESCRIPTION	ThermoBarrier®	ThermoBarrier	ThermoBarrier	ThermoBarrier	Camchiller®	Camchiller	Camwarmer®	Camwarmer
DIMENSIONS (CM)	53 x 33 x 2,5	54 x 33 x 2,5	53 x 33,5 x 3,5	53 x 33,5 x 3,8	53 x 33 x 3,8	53 x 32,5 x 3	53 x 32,5 x 3	34 x 27,5 x 4
FITS	UPC600	UPC800, UPC800SP	UPC1200	UPC1600	UPC600, UPC800, UPC800SP, UPC1200, UPC1600, UPC1600SP	UPC600, UPC800, UPC800SP, UPC1200, UPC1600, UPC1600SP	UPC600, UPC800, UPC800SP	UPC600, UPC800, UPC800SP
COLOR	Coffee Beige (157)	Grey (180)	Dark Brown (131)	Slate Blue (401)	Cold Blue (159)	Glacier Blue (443)	Fire Red (444)	Granite Grey (191)

Case Pack: 1 1200DIV / 1600DIV Case Pack: 2

ULTRA PAN CARRIER® AND ULTRA CAMCART® H-SERIES

- Designed for both electric hot holding and non-electric transport.
- Gentle, 65° to 74°C non-radiant heat will not cook food and maintains food moisture.
- Holds a wide variety of foods such as pasta, bone-in fried chicken, and double-crust pies.
- One hour preheat time from room temperature and three minute recovery.
- Energy consumption is substantially less than comparable metal cabinets.
- Will not rust or dent like metal cabinets, is more economical, and is easy to maneuver.
- All UPCH models have been tested to maintain safe, hot food temperatures, for up to 4 hours when unplugged.
- Models with only the top heated door offer unique versatility with an electric hot holding cabinet on top and passive hot or cold food holding on the bottom.
- Heated door kits also sold separately to retrofit UPC400, UPC800 and UPC1600.

Colors: Granite Gray (191), Black (110), Granite Green (192), Slate Blue (401), Dark Brown (131).

Casters: 15,2 cm 2 fixed, 2 swivel, 1 with brake.



Power On and Heat on Indicators

Communicate the Power and Heating status of the UPCH1600 unit. Know instantly when the compartment has reached target temperature.



Vents

Consistent heating throughout the compartment is generated by vents that constantly circulate heat from front to back.



Tough Exterior

All UPCH units are made of tough, polyethylene with polyurethane foam insulation to keep heat in while keeping the exterior cool to the touch. Will not crack, dent, chip, rust or break.

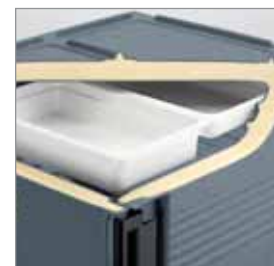

Insulation

Foamed-in place polyurethane foam insulation will hold temperature above 64°C for up to 4 hours when used unplugged.

ULTRA PAN CARRIER® AND ULTRA CAMCART® H-SERIES

Marine rail is designed for use during service, not transport.



MODEL	UPCH4002	UPCH8002	UPCH16002
Electrical Specifications			
REQUIRED VOLTAGE	200 – 230 VAC	200 – 230 VAC	200 – 230 VAC
MAXIMUM AMP.	1,2a	1,2a	2,3a
WATTS	265w	265w	506w
HERTZ	50/60	50/60	50/60
PLUG TYPE	Euro plug, CEE7	Euro plug, CEE7	CEE7/7 to C15RA
POWER CORD LENGTH	2,7 m	2,7 m	2,7 m

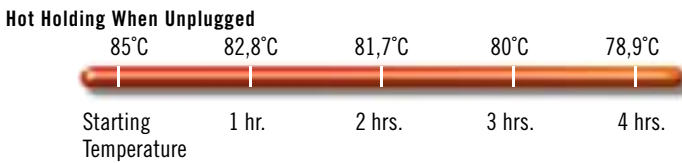

HOT HOLDING	65° – 74°C
WARM UP TIME (from ambient to temperature)	1 hour
RECOVERY TIME* (time to recover to temperature after door is held open for 30 seconds)	3 minutes
TRANSPORT TIME* (after reaching temperature, amount of time unit can be held passively/unplugged until contents reach 65°C.)	4 hours+

*Based on test with 6 each, 15,24 cm deep H-pans with GripLids® filled with approx 14,2 L of 87,7°C water. (Temperatures are of the water not the air in the cart.)

Capacity Guide

UPCH4002
UPCH8002 (x2)
UPCH16002 (x4)

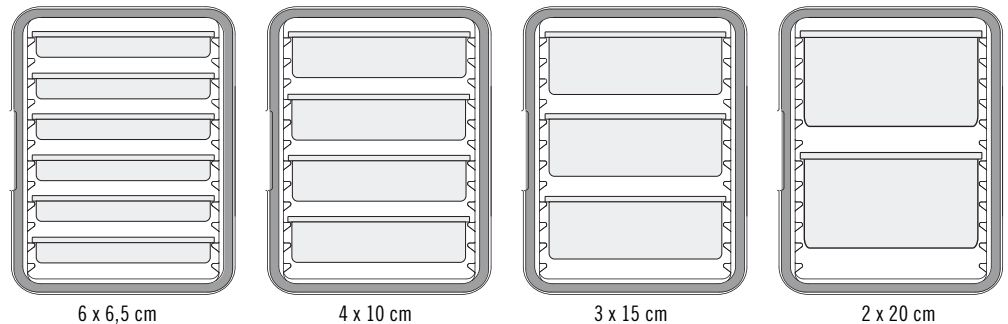

Food Pan Portion Guide

GN 1/1 Food Pan				
DEPTH	20 cm	15 cm	10 cm	6,5 cm
SERVING PORTIONS PER PAN (1 CUP)	80	60	40	30

ULTRA PAN CARRIER® AND ULTRA CAMCARTS® H-SERIES

- Enables HACCP compliance by maintaining safe, hot food temperatures.
- UPCH400(2) models stack for storage or transporting on a Camdolly® with securing strap.

Colors: Granite Grey (191), Granite Green (192), Slate Blue (401), Black (110), Dark Brown (131).

CD400 Colors: Coffee Beige (157), Dark Brown (131), Black (110), Slate Blue (401), Grey (180).

Casters: 15,2 cm 2 fixed, 2 swivel, 1 with brake.

Note: If using metal food pans, cool to 120°C before placing onto rails.

Note: Place food pans on rails. Pans should not be placed on the floor of a Camcart cavity. Please use specified food pan sizes.

Vent Cap Patent Pending.



STOCK PRODUCTS & COLORS AVAILABLE IN OUR EUROPEAN WAREHOUSE

UPCH4002, UPCH8002, UPCHT8002, UPCH16002, CD400: (401)

Security Package (SP)

Specially designed for operations where safety and security are a top priority.

- Tamper-resistant fasteners.
- Non-removable doors.
- Lockable hasp on each door (padlocks not included).
- Heavy duty (HD) casters with chassis plates mounted with tamper-resistant bolts.

CODE	DESCRIPTION	EXTERIOR DIMENSIONS W x D x H	COMPARTMENT DIMENSIONS W x D x H
UPCH1600SP	110V, Both doors heated	73 x 84,7 x 138,4 cm	53,5 x 66,5 x 53,5 cm
UPCH16002SP	220V, Both doors heated	73 x 84,7 x 138,4	53,5 x 66,5 x 53,5

CODE	DESCRIPTION	EXTERIOR DIMENSIONS W x D x H	COMPARTMENT DIMENSIONS W x D x H
1-Compartment Ultra Pan Carriers			
110V			
UPCH400	No casters	46 x 67 x 63 cm	33,5 x 53,3 x 48,6 cm
UPCHW400	With casters	46 x 67 x 79,4	33,5 x 53,3 x 48,6
220V			
UPCH4002	No casters	46 x 67 x 63	33,5 x 53,3 x 48,6
UPCHW4002	With casters	46 x 67 x 79,4	33,5 x 53,3 x 48,6
2-Compartment Ultra Camcarts			
110V			
UPCH800	Both doors heated	52 x 69 x 137,2	33 x 54,5 x 48,5
UPCHT800	Top door heated only	52 x 69 x 137,2	33 x 54,5 x 48,5
UPCH1600	Both doors heated	73 x 84,7 x 137,5	53,5 x 66,5 x 53,5
UPCH1600HD	Both doors heated, HD casters	73 x 84,7 x 138,4	53,5 x 66,5 x 53,5
UPCHT1600	Top door heated only	73 x 84,7 x 137,5	53,5 x 66,5 x 53,5
UPCHT1600HD	Top door heated only, HD casters	73 x 84,7 x 138,4	53,5 x 66,5 x 53,5
220V			
UPCH8002	Both doors heated	52 x 69 x 137,2	33 x 54,5 x 48,5
UPCHT8002	Top door heated only	52 x 69 x 137,2	33 x 54,5 x 48,5
UPCH16002	Both doors heated	73 x 84,7 x 137,5	53,5 x 66,5 x 53,5
UPCH16002HD	Both doors heated, HD casters	73 x 84,7 x 138,4	53,5 x 66,5 x 53,5
UPCHT16002	Top door heated only	73 x 84,7 x 137,5	53,5 x 66,5 x 53,5
UPCHT16002HD	Top door heated only, HD casters	73 x 84,7 x 138,4	53,5 x 66,5 x 53,5
Accessories			
CD400	Camdolly®	53 x 70 x 23	—
400STP	Strap, 5 m long	—	—

UPCH Case Pack: 1

Also Available: Top and Bottom Replacement/Retrofit Doors for 110V and 220V (non-interchangeable).

Standard Casters: 15,2 x 3,2 cm – 2 fixed, 2 swivel, 1 with brake.

Heavy Duty (HD) Casters: 15,2 x 5 cm – 2 fixed, 2 swivel with brake.



New!

PRO CART ULTRA™ (HOT, COLD AND/OR PASSIVE)

The first holding cabinet and transport cart to actively hold both hot and cold food at the same time—without a compressor.

- High capacity cart holds GN food pans, 60 x 40 cm sheet pans, trays and pizza boxes in two separate, insulated cabinets.
- Customize the cart to suit your menu with a choice of active hot, active cold or passive holding in each cabinet.

- Energy efficient, active modules draw less than 5 amps each.
- Cold module uses environmentally-friendly, thermoelectric technology.
- Active modules also sold separately to quickly adapt to menu or operational changes.
- Even without electricity, this cart can maintain safe temperatures for 4+ hours.
- Comes standard with upgraded, 15 cm heavy duty casters.
- 110V and 220V available.

Color: Charcoal Gray (615).

Multiple International Certifications available.



PRO CART ULTRA™ (ELECTRIC HOT AND COLD)



ELECTRIC HOT

Keeps food safely between 65,5° to 74°C with convenient, pre-set, gentle, nonradiant heat.

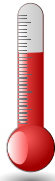

ENERGY-SAVING HEATER over 50% more

energy efficient compared to leading metal carts! Gentle, non-radiant heat circulates consistently from front to back of the cabinet.



Tall Cart

ELECTRIC COLD

Digital controller allows cold to be set from 0,3° to 4,4°C.

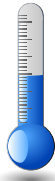

THERMOELECTRIC COOLING cools down to 0,3°C

without a compressor for the ultimate in cold mobility and food safety on the go.

Note: Operate in 32,2°C or less environments for best results.



Interior with Hot module

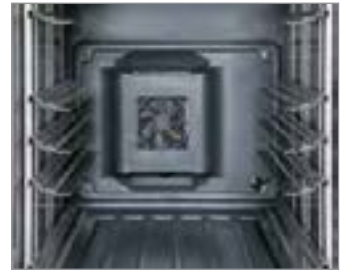

Interior with Cold module



Exterior back with Hot module



Exterior back with Cold module



Low Cart

Pre-heat time: 45 minutes.

Recovery time: 3 minutes after door open for 30 seconds.

Pre-chill time: 90 minutes to 4,4°C. (Tested at 23°C ambient.)

Recovery time: 10 minutes after door open for 30 seconds.

PRO CART ULTRA™ (ELECTRIC HOT AND COLD)



Holds Combinations of GN Food Pans, Sheet Pans, Trays and Pizza Boxes to suit your need.



Holding Capacity Reference



TYPE OF CONTAINER	TALL CART STANDARD CAPACITY	LOW CART STANDARD CAPACITY	TALL CART MAXIMUM CAPACITY	LOW CART MAXIMUM CAPACITY
45,7 x 66 CM FULL SIZE SHEET PANS	16	8	32*	16*
33 x 45,7 CM HALF SIZE SHEET PANS	32	16	64*	32*
GN 1/1 FOOD PANS 6,5 CM DEEP	32	16	32	16
GN 1/1 FOOD PANS 10 CM DEEP	20*	10*	20	10
60 x 40 CM SHEET PAN	16	8	32*	16*
PIZZA BOXES 40,6 x 40,6 x 5,1 CM	16	8	16	8

*Additional rails required.



Easy to change modules add flexibility to any operation.

PRO CART ULTRA™ (ELECTRIC HOT AND COLD)

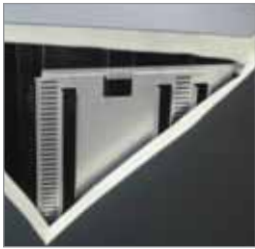

INSULATION
Polyurethane insulation throughout the body and doors maximizes heat or cold retention for 4 hours or more with no electricity needed.



MARINE RAIL
Creates a bonus staging area for food pans.

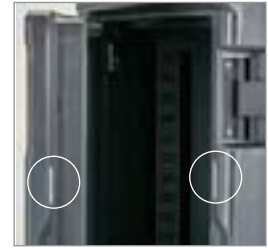

GASKET-FREE DOOR
For easy cleaning and fewer replacement parts. Door opens full 270°.

MAGNETIC QUICK CLOSE FEATURE
Helps the operator close the door with little effort — especially helpful when hands are full.

SOLAR DIGITAL THERMOMETER
Monitor internal cabinet temperature at a glance.

10 CM NYLON LATCHES
For easy opening and closing and to secure contents during transport. (Door is lockable).

12,7 x 20,3 CM MENU POCKET
Allows for easy product ID with either an index card or by writing directly onto smooth surface with a grease pencil.



PERIMETER BUMPER
Protects cart and walls.



STAINLESS STEEL HINGE
for long term durability.

POLYETHYLENE EXTERIOR
Keeps food moist naturally and remains cool to the touch during operation, unlike metal cabinets.

STANDARD 15 x 5 CM HEAVY DUTY CASTERS
Two non-marking, high-performance, all swivel casters with brakes in the front and two rigid casters in the back for smooth positioning and navigation.



Ergonomic Molded-In Handles
Will never break; great for maneuvering by operators of all heights.



Cord Keeper
Stores 2,7 m power cord neatly and safely.





8 Sets of Stainless Steel Universal Style Rails
With 3,8 cm spacing; Hold sheet pans, food pans, pizza boxes and trays (or a combination).



Rail Guides
Numbering corresponding to different holding containers helps speed set-up.

PRO CART ULTRA™ (ELECTRIC HOT AND COLD)

	CODE	DESCRIPTION	UNIT WEIGHT
TALL PROFILE 	Both Compartments Hot		
	PCUHH	110V standard USA / CAN power cord 5-15P	121,3 kg
	PCUHH2	220V USA / CAN power cord 6-15P	121,7
	Both Compartments Cold		
	PCUCC	110V standard USA / CAN power cord 5-15P	126,3
	PCUCC2	220V USA / CAN power cord 6-15P	128,7
	Hot & Cold		
	PCUHC	Top compartment hot, bottom cold. 110V standard USA / CAN power cord 5-15P	122,9
	PCUCH	Top compartment cold, bottom hot. 110V standard USA / CAN power cord 5-15P	122,9
	PCUHC2	Top compartment hot, bottom cold. 220V standard USA / CAN power cord 6-15P	123,1
	PCUCH2	Top compartment cold, bottom hot. 220V standard USA / CAN power cord 6-15P	123,1
	Passive & Hot or Cold		
	PCUPH	Top compartment passive, bottom hot. 110V standard USA / CAN power cord 5-15P	155,8
	PCUPC	Top compartment passive, bottom cold. 110V standard USA / CAN power cord 5-15P	188,3
	PCUPH2	Top compartment passive, bottom hot. 220V standard USA / CAN power cord 6-15P	116
	PCUPC2	Top compartment passive, bottom cold. 220V standard USA / CAN power cord 6-15P	119,5
LOW PROFILE 	PCULH	Hot Cart, 110V standard USA / CAN power cord 5-15P	68,5
	PCULC	Cold Cart, 110V standard USA / CAN power cord 5-15P	70,8
	PCULH2	Hot Cart, 220V standard USA / CAN power cord 6-15P	68,5
	PCULC2	Cold Cart, 220V standard USA / CAN power cord 6-15P	70,8

Case Pack: 1 **Color:** Charcoal Gray (615).

Standard Railing Includes: 8 pairs of stainless steel Universal rails/compartment.

Includes Standard Casters: 15 x 5 cm heavy duty swivel with brake in front, rigid in back.

Options: Security Package (S) available by special request.

Code number will vary depending on plug required please contact Cambro Customer Service.

Unit Dimensions

UNIT	EXTERIOR DIM. W x D x H	COMPARTMENT DIM. W x D x H
Tall Profile		
COLD	71,1 x 92,7 x 167,6 cm	53,7 x 66,7 x 64,8 cm
HOT / PASSIVE	71,1 x 90,8 x 167,6	53,7 x 68,6 x 64,8
Low Profile		
COLD	71,1 x 92,7 x 101,6	53,7 x 68,6 x 64,8
HOT / PASSIVE	71,1 x 90,8 x 101,6	53,7 x 68,6 x 64,8

Electrical Specifications (Per Compartment)

	HOT 110V	HOT 220V	COLD
REQUIRED VOLTAGE	100-125 VAC	200-230 VAC	100-230 VAC
MAXIMUM AMP	4,6a	2,3a	3,26a, 1,42a
WATTS / HEATER OR COOLER	529w	506w	326,6w
HERTZ	50/60	50/60	50/60
PHASE	Single	Single	Single
ALTERNATE PLUG TYPES FOR INTERNATIONAL*	US, Canada, Mexico, Europe, UK, Ireland, Australia, South Africa, China, Japan		
POWER CORD LENGTH	2,7 m	2,7 m	2,7 m

Optional Accessories

CODE	DESCRIPTION
PCMH / PCMH2	Hot module unit, 110V / 220V
PCMC / PCMC2	Cold module unit, 110V / 220V
PCMP	Passive unit
SSR1	1 pair of rails
SSR8	8 pairs of rails

Case Pack: 1 **Color:** (000).



PRO CART ULTRA™ (NON-ELECTRIC / PASSIVE)



MARINE RAIL
Creates a bonus staging area for food pans.

Color: Charcoal Gray (615).

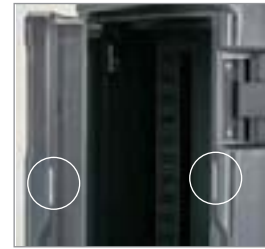

8 SETS OF STAINLESS STEEL UNIVERSAL STYLE RAILS

With 3,8 cm spacing; hold sheet pans, food pans, pizza boxes and trays (or a combination).

GASKET-FREE DOOR

For easy cleaning and fewer replacement parts. Door opens full 270°.

MAGNETIC QUICK CLOSE FEATURE

Helps the operator close the door with little effort — especially helpful when hands are full.

SOLAR DIGITAL THERMOMETER

Monitor internal cabinet temperature at a glance.

10 CM NYLON LATCHES

For easy opening and closing and to secure contents during transport. (Door is lockable).

12,7 x 20,3 CM MENU POCKET

Allows for easy product ID with either an index card or by writing directly onto smooth surface with a grease pencil.



STANDARD 15 x 5 CM HEAVY DUTY CASTERS

Two non-marking, high-performance, all swivel casters with brakes in the front and two rigid casters in the back for smooth positioning and navigation.

PERIMETER BUMPER

Protects cart and walls.



STAINLESS STEEL HINGE
for long term durability.

POLYETHYLENE EXTERIOR

Keeps food moist naturally and remains cool to the touch during operation, unlike metal cabinets.



INSULATION

Polyurethane insulation throughout the body and doors maximizes heat or cold retention for 4 hours or more with no electricity needed.



Interior

Easy to clean interior.



Exterior Back

Non-electric cart holds hot or cold foods for 4 hours or more.



Ergonomic Molded-In Handles

Will never break; great for maneuvering by operators of all heights.



Rail Guides

Numbering corresponding to different holding containers helps speed set-up.

PRO CART ULTRA™ (NON-ELECTRIC / PASSIVE)

CODE	DESCRIPTION	EXTERIOR DIM. W x D x H	UNIT WEIGHT
Tall Profile			
PCUPP	Both compartments non-electric / passive	71,1 x 90,8 x 167,6 cm	106,7 kg
Low Profile			
PCULP	Non-electric / passive	71,1 x 90,8 x 101,6	63,5

Case Pack: 1 **Color:** Charcoal Gray (615).
Standard Railing Includes: 8 pairs of stainless steel Universal rails/compartments.
Includes Standard Casters: 15 x 5 cm heavy duty swivel with brake in front, rigid in back.
Compartment Dimensions: 53,7 x 68,6 x 64,8 cm.
Options: Security Package (S) available by special request.

Optional Accessories

CODE	SSR1	SSR8
DESCRIPTION	1 pair of rails	8 pairs of rails

Case Pack: 1 **Color:** (000).

Hot — temperature loss averaging 1,5°C/hour.

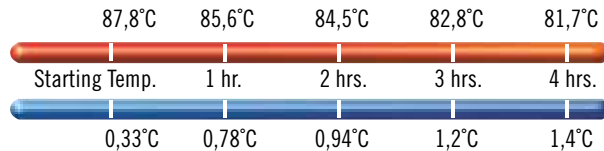

Cold — temperature gain averaging 0,4°C/hour.



Security Package (S)

Specially designed for operations where safety and security are a top priority.

- Tamper resistant fasteners secure side column panels to the cart.
- Cross locking rods behind column panels lock 5 rails in place.
- Each compartment holds ten 10 cm deep hotel pans.
- Passive and electrical modules and cord strap keepers are secured in place with tamper resistant fasteners.
- Non removable doors. Lockable HASP secures both doors at once. (Lock not included).
- Heavy duty casters mounted with tamper resistant fasteners.



INSULATED BEVERAGE CONTAINERS



- Use to hold, transport and serve hot or cold beverages.
- One piece, seamless double-wall polyethylene with thick foam insulation.
- Sturdy latches secure lids tightly and will never rust.
- Drip-proof recessed spigot for easy self-serve access.
- Stack units on riser to fill large cups or coffee pots.
- Sta-stack interlocking ensures stable stacking during transport and storage.

Easy Serve Dispenser Color:
Black (110).

UC1000 covered by U.S. Patent D 403,916.

Vent Cap patent pending.

350LCD Camtainer not NSF.



Vent Cap

Equalizes pressure. Makes the opening of the container much easier.

E-Z Grip Molded-in Handles

For comfortable, safe transporting.

Camtainer Cover

Durable and attractive covers extend the life of your Camtainers and fit in any serving environment.

Personalization available. Contact your Cambro representative for details. (Models for covers on next page.)



Recessed Faucet

Accommodates larger cups. Allows even dispensing and eliminates drips. Two positions: One for continuous pouring and one for individual dispensing.



Molded-in Metal Backing Plates

Prevents latches from breaking away from the container.



Stack beverage servers during storage and transporting to save space.

Stacking options:

- 100LCD with 100LCD
- All 250, 350 and 500 units
- UC1000 and 1000LCD

Hot

250LCD	87°C	84,5°C	82°C	79°C	77°C
UC250	88°C	85,5°C	84°C	82°C	80°C

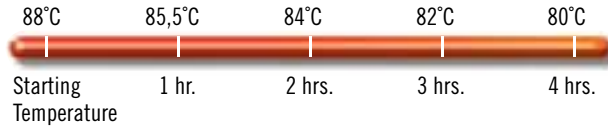

Cold

250LCD	1°C	1,5°C	2°C	3°C	4°C
UC250	0,5°C	1°C	1°C	1,5°C	2°C

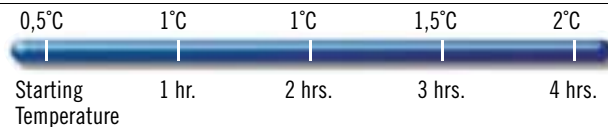

Ultra Camtainers®

Feature wide nylon latches which are easy to open and close with one hand.



Camtainers®

Feature sturdy plastic latches that secure lids tightly and will never rust.

Ultra Camtainers®

Choose from three sizes for beverage service. A contemporary line, featuring two wide nylon latches per unit that are easy to open and close.

STOCK PRODUCTS & COLORS AVAILABLE IN OUR EUROPEAN WAREHOUSE

UC250, UC500: (401), (191)
UC1000: (401)



CODE	UC250	UC500	UC1000
CAPACITY	10,4 L	19,9 L	39,7 L
210 ML. CUPS	50	96	192
EXTERIOR DIMENSIONS D x W x H	42,5 x 30 x 50 cm	42,5 x 30 x 68 cm	52 x 41,5 x 65,5 cm
FITS CAMDOLLY	CD100H, CD1826H, CD300H, CD100HB, CD300HB, CD100	CD100H, CD1826H, CD300H, CD100HB, CD300HB, CD100	CD300H, CD1826H, CD2020H, CD100HB, CD300HB, CD1826MTCHB, CD300, CD2020
CAMTAINER COVER	UC250CVR	UC500CVR	UC1000CVR

Case Pack: 1 **Colors:** Navy Blue (186), Slate Blue (401), Coffee Beige (157), Dark Brown (131), Brick Red (402), Green (519), Black (110), Granite Grey (191), Granite Green (192), Granite Sand (194). **Cover Color:** Black (110). Venting plug is covered by US Patent D 553,717 S.

Camtainers®

The standard for many caterers, choose from four sizes for beverage service and one model without a spigot for soup service. Four sturdy plastic latches on each unit open and close easily and will never rust.

STOCK PRODUCTS & COLORS AVAILABLE IN OUR EUROPEAN WAREHOUSE

250LCD, 350LCD, 500LCD: (157), (401)
100LCD: (401)



CODE	100LCD	250LCD	500LCD	1000LCD	350LCD (SOUP)
CAPACITY	5,7 L	9,5 L	17,9 L	44,5 L	12,7 L
210 ML. CUPS	27	45	85	214	60
SPIGOT	YES	YES	YES	YES	—
EXTERIOR DIMENSIONS D x W x H	29 x 26,5 x 44 cm	42 x 23 x 47 cm	42 x 23 x 62 cm	53 x 41,5 x 63 cm	42 x 23 x 47 cm
FITS CAMDOLLY	CD1420	CD100H, CD1826H, CD300H, CD2020H, CD100HB, CD300HB, CD1826HB, CD2020HB, CD100, CD2020	CD100H, CD1826H, CD300H, CD2020H, CD100HB, CD300HB, CD1826HB, CD2020HB, CD100, CD2020	CD300H, CD1826H, CD2020H, CD100HB, CD300HB, CD1826MTCHB, CD300, CD2020	CD100H, CD1826H, CD300H, CD2020H, CD100HB, CD300HB, CD1826HB, CD2020HB, CD100, CD2020
CAMTAINER COVER	—	250LDCVR	500LDCVR	1000LDCVR	—

Case Pack: 1 **Colors:** Navy Blue (186), Slate Blue (401), Coffee Beige (157), Dark Brown (131), Brick Red (402), Green (519), Black (110), Hot Red (158). **Cover Color:** Black (110). Venting plug is covered by US Patent D 553,717 S.

Camserver®— Holds The Heat for Hours.

- A front-of-house beverage server for hot or cold beverages that does not require canned heating.
- Double-wall polyethylene shell with thick foam insulation retains temperatures for hours.

Colors: Black (110), Dark Taupe (417), Granite Grey (191).



Convenient top-fill opening for fast replenishment without removing lid.

CSR3 Shown in Dark Taupe Height is approximate 18 cm from counter to spigot.



CSR5 Shown in Black

CODE	EXTERNAL DIM. H x W x D	CAPACITY	210 ML CUPS	CASE PACK
CSR3	60 x 34 x 46,5 cm	11,5 L	54	1
CSR5	71 x 34 x 46,5	19	91	1

HANDWASH ACCESSORY –

FOR CAMTAINERS® AND ULTRA CAMTAINERS®

- Set up a Handwashing Station quickly and easily on or off premise.
- Convenient and economical way to meet health department hand washing requirements.
- Attaches to Camtainers 250LCD, 500LCD or Ultra Camtainers UC250, UC500.
- Includes four Handwash Only labels and an Easy Serve Dispenser lever.

Handwash Accessory Stocking Colors:
Dark Brown (131), Black (110).

Easy Serve Dispenser Color: Black (110).

Riser Colors: See optional accessories with Camtainers.

Pail with Bail Color: White (148).

Handwash Accessory is covered by the following U.S. Patent D 506,634 S & D 506,899 S.



Shown with 500LCD Camtainer.



CODE	HWAPR	HWATD
DESCRIPTION	With paper towel roll holder	With multi-fold paper towel dispenser
FITS	250LCD, 500LCD, UC250, UC500	250LCD, 500LCD, UC250, UC500

Optional Accessories



CODE	R500LCD	R1000LCD	LCDCH	LCDCH10
DESCRIPTION	Riser	Riser	Condiment Holder	Condiment Holder
EXTERIOR DIM. D x W x H	41,5 x 23 x 12 cm	49,5 x 39 x 11,5 cm	42 x 22 x 13 cm	51 x 41 x 12 cm
FITS	250LCD, 500LCD, UC250, UC500	1000LCD, UC1000	250LCD, 500LCD, UC250, UC500	1000LCD, UC1000

Case Pack: 1 Colors: Coffee Beige (157), Dark Brown (131), Black (110).



CODE	PWB22	LCDES
DESCRIPTION	Pail with Bail	Easy Serve Dispenser
FITS	—	LCD Spigots UC Spigots
CASE PACK	6	1

BEVERAGE SERVICE CARTS

- Ideal for breakfast, coffee or snack service.
- Use top counter to hold Cambro Beverage Servers, Versa Organizer Bins or Display Trays with Covers for food.
- Store drinkware, additional food items or other supplies in open compartment.
- Insulated cabinets hold hot or cold food in full, 1/2 or 1/3 size food pans or on Cambro Metric Camtrays® (3253).

Colors: Slate Blue (401), Granite Grey (191), Granite Green (192).

 See Organizer section for more information on Organizer Bins.

 See Camtainer section for more information on Camtainers.

Wire Rack Color: Silver (000).

 See Cold Pack section for more information on Cold Packs.

15,2 cm Casters: 2 fixed, 2 swivel, 1 with brake.

 For complete specifications, call or write Cambro.



Beverage Service Cart is designed to hold Beverage Containers at point of service only. A dolly or hand truck with safety strap is recommended for moving Beverage Containers over longer distances or uneven surfaces.



MDC24F

STOCK PRODUCTS & COLORS AVAILABLE IN OUR EUROPEAN WAREHOUSE

5412CBP: (131), (480)
 100LCD: (401)

CODE	EXTERIOR DIM. L x W x H	CASE PACK
MDC24	113 x 76 x 112 cm	1
MDC24F	113 x 76 x 112	1
OPTIONAL ACCESSORIES		
Organizer Bin		
5412CBP	30,5 x 13 x 11	12
Camtainer®		
100LCD	26,5 x 30 x 44	1
Wire Rack		
MDC24R	58,4 x 43,2 x 35,5	1
Camchiller®		
CP1220	53 x 33 x 3,8	1

The use of racks in the MDC24 and MDC24F carts will allow the following configuration of pans or trays, per compartment:

DESCRIPTION	GN 1/1	GN 1/2	GN 1/3
6,5 cm Pans	(4) 12CW	(8) 22CW	(12) 32CW
10 cm Pans	(3) 14CW	(6) 24CW	(9) 34CW
15 cm Pans	(2) 16CW	(4) 26CW	(6) 36CW
20 cm Pans	(1) 18CW**	(2) 28CW**	(3) 38CW**

**With room for 6,5 cm or 10 cm pan above 15 cm pan.
 10 each 3253 Metric Camtrays®.

Compartment Dimensions

Shelf Compartment	W 96,5 cm	D 64 cm	H 25,4 cm
Holding Compartments	W 44,5 cm	D 60,3 cm	H 36 cm

Venting plug is covered by US Patent D 553,717 S.



MDC24 has recessed top that holds 3 each 3,8 Liters 100LCD Camtainers and stacked Condiment Bins & Wire Rack with 3253 trays.

MDC24R Wire Rack

Wire Rack (sold separately) to organize pans and trays in the cart. Rack holds Full, 1/2 and 1/3 size Food Pans and 3253 trays. When placed in cart's core area, the rack allows room on either side of pan positions for Cambro's CP1220 Camchillers® one on each side.



INSULATED BAKERY CONTAINER – 60 X 40 CM



- Designed for the baking industry in Europe.
- Ideal for transporting products at safe cold temperatures to satellite locations.
- Perfect for baked items with cream fillings or frozen dough.
- Made with a durable polyethylene outer shell and thick polyurethane foam insulation.
- Holds sheet pans:
60 x 40 cm
58 x 40 cm
58 x 20 cm
58 x 10 cm
or fiberglass tray: 60 x 40 cm
- Choose between wire racks with 6 rails, 10 cm apart, or 7 rails, 8,7 cm apart.

CP6040 color: Cold Blue (159).

Wire rack color: Silver (000).

Fiberglass Tray colors: Speckled Smoke (A20), Speckled Mocha (A21), Sahara (A22), Light Grey (A27), Pearl White (A33), Terrazzo (A86).

Note: Place sheet pans on rails. Pans should not be placed on the floor of a Container cavity. Please use specified sheet pan sizes.

Vent Cap Patent Pending.



Camdolly® CD300 makes it easy to transport BK60406 or BK60407.



CODE	BK60406*	BK60407*
DESCRIPTION	Container with 6 rails	Container with 7 rails
EXT. DIM.	57 x 76,5 x 82 cm	57 x 76,5 x 82 cm
INT. DIM.	42 x 63,5 x 67,5 cm	42 x 63,5 x 67,5 cm
Case Pack: 1	Color: Navy Blue (186)	*Includes 2 wireracks and 1 chiller.

Accessories

CODE	CD300	CP6040	WR60406	WR60407	GL4060**
DESCRIPTION	Camdolly	Camchiller®	Wiereracks w/6 rails	Wiereracks w/7 rails	Market display tray
EXT. DIM.	49 x 65 x 26,5 cm	60 x 40 x 4 cm	66 x 40,5 x 5,8 cm	66 x 40,5 x 5,8 cm	60 x 40 cm
INT. DIM.	43 x 59 cm	—	—	—	—
CASE PACK	1	1	1	1	12

**Not sold in USA, Canada, Mexico, Central America and Caribbean. Vent Cap Patent Pending.

CAMCARTS® – 46 X 66 CM TRAYS, SHEET PANS AND FOOD BOXES

- Use to hold hot or cold bulk food stored on trays, sheet pans or in food boxes.
- Durable polyethylene and thick foam insulation retain safe food temperatures.
- Sturdy plastic, rust-proof latches are secured into molded-in mounting plates.
- Molded-in handle on the back for easy maneuvering.



1826DTC Double Cavity Cart for Trays and Sheet Pans

Capacity: 24 tray support rails on 4,92 cm centers (12 per cavity). Holds up to 24 each 46 x 66 cm trays or sheet/bun pans.

1826DBC Double Cavity Cart for Food Storage Boxes

Capacity: 26 support rails on 4,92 cm centers (13 per cavity). Holds 46 x 66 cm Food Storage Boxes.

Camcart with Security Package

Specially designed for high security applications, with tamper-resistant hardware: metal hinges with non-removeable pins, metal latches with welded bails, lockable hasp and chassis plate.

Colors: Slate Blue (401), Coffee Beige (157), Dark Brown (131), Charcoal Gray (615).

15,2 cm Casters: 2 fixed, 2 swivel, 1 with brake.

Note: Cool metal sheet pans to 121°C before placing onto tray supports.

Venting plug is covered by US Patent D 553,717 S.

Only 1826DBC and 1826DBCSP are NSF Listed.



CODE	DESCRIPTION	EXTERIOR DIMENSIONS W x D* x H	INTERIOR DIMENSIONS W x D x H
1826DTC	For trays & sheet pans	55 x 84,5 x 162 cm	46,4 x 67,3 x 64,6 cm
1826DBC	For food storage boxes	55 x 84,5 x 162	46,4 x 67,3 x 64,9
Camcarts with Security Packages			
1826DTCSP	For trays & sheet pans	55 x 84,5 x 162	46,4 x 67,3 x 64,6
1826DBCSP	For food storage boxes	55 x 84,5 x 162	46,4 x 67,3 x 64,9

Case Pack: 1 *Exterior Depth measurement includes handle.

CAMCARRIERS® & CAMCARTS®



Camcarriers

- Holds 32,5 x 53 cm trays, sheet pans and GN food pans.
- One piece seamless construction with molded-in handles.

Colors: Black (110), Slate Blue (401), Coffee Beige (157), Dark Brown (131), Navy Blue (186), Charcoal Gray (615).
1318CC also available in Hot Red (158).

Note: Cool metal sheet pans to 121°C before placing onto tray supports.

Venting plug is covered by U.S. Patent D 553,717S.



Combo Carrier

1318CC

Holds half-size sheet pans, trays and a variety of food pan sizes. Safely keeps cold food below 4°C, hot food above 63°C for 4+ hours. Interstacks with UPC300, 300MPC, 1318MTC

EXTERNAL DIM. W x D x H*:
43,2 x 65,4 x 56,8 cm

INTERIOR DIM. W x D x H:
33,7 x 53,3 x 35,5 cm

FITS CAMDOLLY:
CD300, CD300H, CD300HB

Case Pack: 1 *With Handle.



Camcarrier

1826MTC

Holds up to 6 each 46 x 66 cm sheet pans. Six tray supports on 5,4 cm centers

EXTERNAL DIM. W x D x H*:
55 x 74,5 x 57 cm

INTERIOR DIM. W x D x H:
46,7 x 66,4 x 35,9 cm

FITS CAMDOLLY:
CD1826MTC, CD1826MTCHB

Case Pack: 1 *With Handle.



1826HAR

Lifting harness

DIMENSION: 360,68 cm long

Color: Beige (000).

Camcarts

- Holds 46 x 66 cm trays, sheet pans and food boxes.
- Includes removable cutting board on top.
- Security Package (SP)* features tamper-resistant hardware to protect both cart and contents. Includes chassis plates with 15,2 x 3,8 cm HD Casters.

Colors: Slate Blue (401), Coffee Beige (157), Dark Brown (131), Navy Blue (186), Charcoal Gray (615).

Standard Casters: 15,2 x 3,2 cm, 2 fixed, 2 swivel, 1 with brake.

Heavy Duty (HD) Casters: 15,2 x 5 cm, 2 fixed, 2 swivel, no brake.

Note: Cool metal sheet pans to 121°C before placing onto tray supports.

Venting plug is covered by U.S. Patent D 553,717S.



Camcart for Food Storage Boxes

1826LBC / 1826LBCSP*

Holds 46 x 66 cm Food Storage Boxes. Capacity: 13 supports on 4,45 cm centers

EXTERNAL DIM. W x D x H:
55 x 81,5 x 95,5 cm

INTERIOR DIM. W x D x H:
46 x 66,4 x 65,7 cm

Case Pack: 1



Camcart for Trays and Sheet Pans

1826LTC / 1826LTCSP*

Holds up to 13 each 46 x 66 cm trays or sheet pans. Thirteen tray supports on 4,45 cm centers

EXTERNAL DIM. W x D x H:
55 x 81,5 x 95,5 cm

INTERIOR DIM. W x D x H:
46 x 66,4 x 65,7 cm

Case Pack: 1



Camcart for Trays and Sheet Pans

1826LTC3

Holds up to 7 each 46 x 66 cm trays or sheet pans. Seven tray supports on 9,5 cm centers for 7,62 cm clearance between trays

EXTERNAL DIM. W x D x H:
55 x 81,5 x 95,5 cm

INTERIOR DIM. W x D x H:
46 x 66,4 x 65,7 cm

Case Pack: 1



MERCHANDISING EQUIPMENT

Versa Food Service System

Versa Food Bar® and Versa Work Table Ultra Series

Food Bar Accessories

Table Top Food Bars, Buffet Bars & Sneeze Guards

Sample Food Bar Set-ups

CamKiosk® System

Hand Sink Cart

Camcruiser® Vending Carts

Camshelving® Flex Station

Booster Seats & Versa Organizers

Portable CamBars®

SlidingLid™ Ice Caddies



VERSA FOOD SERVICE SYSTEM

The Versa Food Service System provides custom design without the custom price. This non electric, versatile, portable system keeps food cold for hours with either ColdFest® pans or Buffet Camchillers®. The system is made of durable all-weather material and is easy to clean. The Versa Food Service System offers countless configurations to fit any foodservice need.

- Ergonomic, molded-in handles on both sides ensure easy maneuvering.
- Versa Food Bar and Work Table both include a drain faucet that can be connected to a hose for drainage and easy cleaning.
- Add an end table to a Food Bar or Work Table to hold trays, condiments, or paper goods.

Versa Cart

- Join a Versa Cart with a Food Bar or Work Table for fast check-out and improved traffic flow.
- The Versa Cart includes an adjustable shelf, standard lockable drawer and convenient electrical access through the top of the cart and front design panel.
- Optional Tray rails easily adjust to a lower height.
- Optional pull-out keyboard tray fits inside the drawer.



Versa Food Service System is covered under U.S. Patent 9,084,498 B2.



All components are fully compliant with NSF requirements.



Versa Straight Connector and Versa Corner Connector

Easily and safely attach multiple components together to create a contiguous system and maximize space and merchandising options.



Versa Food Bar® Lighting Kit

Enhance your foodservice presentation with the LED lighting accessory. The light uses a 12 volt long-lasting battery that charges with an universal charger.

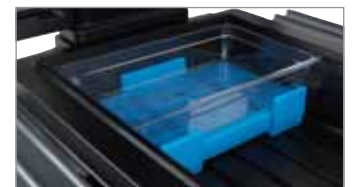

Buffet Camchillers®

Extend safe, cold holding time without ice. Dual-sided Buffet Camchillers hold 6,5 and 10 cm pans. Fits in the Versa Food Bar, Versa Work Table and Table Top Food Bars.

VERSA FOOD SERVICE SYSTEM

Whether you're looking to maximize space, improve traffic flow, add merchandising space or create an upscale salad bar, the Versa Food Service System has you covered.



Versa Food Bar

NSF
All components are fully compliant with NSF requirements.



Versa Work Table

- Perfect for a prep table, display, self-serve station or back bar.
- Attach a Work Table to a Food Bar to merchandise snacks and beverages.
- Matching well covers are included with each Versa Work Table.

Standard height model.

VERSA BAR AND VERSA WORK TABLE – ULTRA SERIES

- Now available with two secure storage cabinets that can hold up to 22,7 kg per compartment of non-perishable items.



NSF
All components are fully compliant with NSF requirements.

Storage Dimensions:
L 54,61 x W 44,45 x H 45,72 cm per cabinet.
Each cabinet is 0,11 M³.

VERSA FOOD SERVICE SYSTEM

CODE	DESCRIPTION	OVERALL EXTERIOR DIMENSIONS L x W x H	FULL PAN SIZE CAPACITY	WELL INTERIOR DIMENSIONS L x W x H
Versa Food Bars® – Standard Height				
VBR5	152 cm with standard casters	175,3 x 108 x 159,4 cm	4	132,8 x 53,3 x 18 cm
VBRHD5	152 cm with heavy duty casters	175,3 x 108 x 159,4	4	132,8 x 53,3 x 18
VBR6	183 cm with standard casters	208,3 x 108 x 159,4	5	165,4 x 53,3 x 18
VBRHD6	183 cm with heavy duty casters	208,3 x 108 x 159,4	5	165,4 x 53,3 x 18
Versa Food Bars Ultra Series – Standard Height				
VBRU5	152 cm with standard casters and storage	175,3 x 108 x 159,4	4	132,8 x 53,3 x 18
VBRUHD5	152 cm with heavy duty casters and storage	175,3 x 108 x 159,4	4	132,8 x 53,3 x 18
VBRU6	183 cm with standard casters and storage	208,3 x 108 x 159,4	5	165,4 x 53,3 x 18
VBRUHD6	183 cm with heavy duty casters and storage	208,3 x 108 x 159,4	5	165,4 x 53,3 x 18
Versa Food Bars – Low Height				
VBRL5	152 cm with standard casters	175,3 x 108 x 141,6	4	132,8 x 53,3 x 18
VBRLHD5	152 cm with heavy duty casters	175,3 x 108 x 141,6	4	132,8 x 53,3 x 18
VBRL6	183 cm with standard casters	208,3 x 108 x 141,6	5	165,4 x 53,3 x 18
VBRLHD6	183 cm with heavy duty casters	208,3 x 108 x 141,6	5	165,4 x 53,3 x 18
Versa Work Tables – Standard Height				
VBRT5	152 cm with standard casters	175,3 x 68,6 x 92,1	4	132,8 x 53,3 x 18
VBRTHD5	152 cm with heavy duty casters	175,3 x 68,6 x 92,1	4	132,8 x 53,3 x 18
VBRT6	183 cm with standard casters	208,3 x 68,6 x 92,1	5	165,4 x 53,3 x 18
VBRTHD6	183 cm with heavy duty casters	208,3 x 68,6 x 92,1	5	165,4 x 53,3 x 18
Versa Work Tables Ultra Series – Standard Height				
VBRUT5	152 cm with standard casters and storage	175,3 x 68,6 x 92,1	4	132,8 x 53,3 x 18
VBRUTHD5	152 cm with heavy duty casters and storage	175,3 x 68,6 x 92,1	4	132,8 x 53,3 x 18
VBRUT6	183 cm with standard casters and storage	208,3 x 68,6 x 92,1	5	165,4 x 53,3 x 18
VBRUTHD6	183 cm with heavy duty casters and storage	208,3 x 68,6 x 92,1	5	165,4 x 53,3 x 18
Versa Work Tables – Low Height				
VBRTL5	152 cm with standard casters	175,3 x 68,6 x 74,3	4	132,8 x 53,3 x 18
VBRTLHD5	152 cm with heavy duty casters	175,3 x 68,6 x 74,3	4	132,8 x 53,3 x 18
VBRTL6	183 cm with standard casters	208,3 x 68,6 x 74,3	5	165,4 x 53,3 x 18
VBRTLHD6	183 cm with heavy duty casters	208,3 x 68,6 x 74,3	5	165,4 x 53,3 x 18

Case Pack: 1

CODE	DESCRIPTION	OVERALL EXTERIOR DIMENSIONS L x W x H
Versa Cart		
VCSWR	With dual tray rails and standard casters	134 x 81,9 x 109,2 cm (with tray rails up)
VCSWRHD	With dual tray rails and heavy duty casters	134 x 81,9 x 109,2 (with tray rails up)
VCS	With standard casters and no tray rails	81,3 x 81,9 x 109,2
VCSHD	With heavy duty casters and no tray rails	81,3 x 81,9 x 109,2
Connectors		
VBRC	Straight connector - food bar to food bar	68,6 x 48,3 x 10,8
VBRC90	Corner connector - food bar to food bar	91,4 x 91,4 x 10,8
VCS32CNT	Straight connector - cart to standard height food bar / work table	68,6 x 51,75 x 8,26
VCSCNL	Straight connector - cart to low height food bar / work table	68,6 x 51,75 x 21,59

Case Pack: 1 Versa Food Bar, Versa Work Table, Versa Cart, Connectors, Well Cover Colors: Black (110), *Hot Red (158), *Navy Blue (186), *Kentucky Green (519).

Tray Rail and End Table Colors Only: Granite Gray (191), **Black (110).

*Made to order colors for Versa Food Bar, Versa Work Table, Versa Cart, Connectors, Well Cover, Tray Rail and End Table.

**Made to order color for Tray Rail and End Table only. Made to order items not carried in stock, non-returnable.

FOOD BAR ACCESSORIES

Every Accessory You Need

- Crock and Salad Bowl Holders highlight and organize salads, condiments and dressings.
- Tray Rails offer convenience for your patrons.

See Camwear® Food Pans and Crocks section for more information.

Versa Cart with Dual Tray Rails (VCSWR & VCSWRHD): All orders receive the tray rails in Granite Gray (191). To choose a different color tray rail you must order the Versa Cart Without Rails (VCS or VCSHD) and the tray rails (VCS32R) separately.

Connector Colors: Black (110), Hot Red (158), Navy Blue (186), Kentucky Green (519).

Vinyl Cover Color: Opaque (000).

Sign Holder Color: Clear (152).

Buffet Camchiller® Color: Cold Blue (159).

Divider Bar Colors: White (148), Clear (152).

Well Cover Colors: Black (110), Hot Red (158), Navy Blue (186), Kentucky Green (519).

Keyboard Tray Color: Black (110).

Crock, Salad Bowl Holders Colors: White (148), Granite Gray (191).

Versa Food Bar is covered under U.S. Patent D 615,323 S and D 620,730. Versa Food Bar Ultra Series is covered under U.S. Patent D702,066 S. Versa Cart is covered under U.S. Patent D 653,830 S. Buffet Camchiller is covered under U.S. Patent D 618,4765 S. All other parts patent pending.

*Items are not NSF Listed.

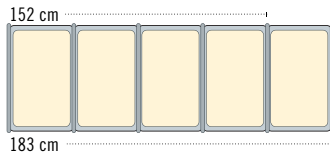

– 183 cm models hold 5 full size Pans with Divider Bars.

– 152 cm models hold 4 full size Pans with Divider Bars.

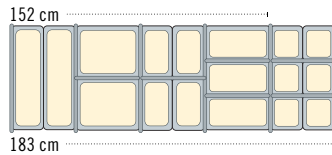

– Fractional Size Pans can be used in many variations with Divider Bars. Mix and match sizes to fit your needs.

Two Salad Bowl Holder models available, SBH18 and SBH15. Crock Holder, CPH3, holds 1,4 and 2,6 L crocks.

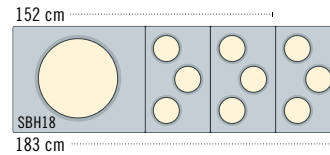

– 183 cm models hold a Salad Bowl Holder and 3 ea. Crock Holders.

– 152 cm models hold a Salad Bowl Holder and 2 ea. Crock Holders.

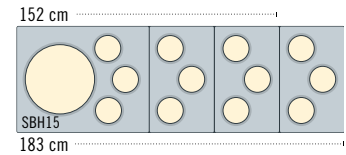

CODE	DESCRIPTION	OVERALL EXTERIOR DIMENSIONS L x W x H	CASE PACK
VBRR5	Tray rail for 152 cm - Versa Food Bar / Versa Work Table	134,6 x 29,2 x 11,6 cm	1
VBRR6	Tray rail for 183 cm - Versa Food Bar / Versa Work Table	167,6 x 29,2 x 11,6	1
VCS32R	Tray rail for - Versa Cart	71,12 x 29,7 x 12,7	1
VBRTBL	End table for Versa Food Bar and work table	68,6 x 55,88 x 11,43	1
LED54LIGHTPKG*	LED light strip 137 cm long with brackets, battery and wall charger	137	1
VBRCVR5*	Vinyl cover for 152 cm Versa Food Bar	185,4 x 110,5 x 116,8	1
VBRCVR6*	Vinyl cover for 183 cm Versa Food Bar	210,8 x 110,5 x 116,8	1
VBRTCVR5*	Vinyl cover for 152 cm Versa Work Table	177,8 x 85,1 x 53,3	1
VBRTCVR6*	Vinyl cover for 183 cm Versa Work Table	210,8 x 85,1 x 53,3	1
VCSCVR*	Vinyl cover for Versa Cart	106,7 x 83,8 x 91,4	1
VBRSHTS*	Versa Food Bar sign holder	91,4 x 15,2 x 23,5	1
DIV12	30,5 cm divider bars	32,39	3
DIV20	51 cm divider bars	53,02	3
CPH3	Crock holder holds 1,4 & 2,6 L	L 33 x W 53	1
SBH15	Salad bowl holder holds a 38,1 cm bowl and 3 crocks	L 65,5 x W 53	1
SBH18	Salad bowl holder holds an 45,7 cm bowl	L 65,5 x W 53	1
CPB1220	Buffet Camchiller for Versa Food Bars, Work Tables and table top food bars	46,99 x 32,07 x 10,16	1
VBRWC	Versa well cover for Versa Food Bar/Work Table	53,02 x 33,02 x 5,08	1
VCS32KEYT	Versa Cart keyboard tray	52,4 x 25,71 x 5,08	1

Versa Food Bar includes Versa Food Bar with and without cabinet.

TABLE TOP FOOD BARS, BUFFET BARS & SNEEZE GUARDS



Table Top Food Bars

- Turn a 122-183 cm table into a double-sided self service buffet or beverage station.
- Thick, foam-insulated well keeps food cold for hours with Buffet Camchillers or ice.
- Drain plug allows for quick and easy clean-up.

Buffet Bars

- Ideal for holding snacks and cold beverages.
- The Buffet Bar with Sneeze Guard is perfect for single-sided, self-serve buffets.

Food Bar Colors: Black (110), Navy Blue (186), Kentucky Green (519), Hot Red (158).

Crock Holder and Salad Bowl Holders available in White (148), Granite Gray (191), Sandstone (614).

BUF48 and BUF72 are NSF listed.

NSF listed for non-direct food contact only.



4FBRTT Table Top Food Bar
Buffet Camchiller® available.



FSG480 Sneeze Guard
The Free Standing Sneeze Guard is the perfect showcase for salad or dessert items.



BUF48 Buffet Bar Base
Merchandises soft drinks on ice to increase beverage sales.



BBR480 Buffet Bar with Sneeze Guard

CODE	OVERALL EXTERIOR DIMENSIONS	FULL SIZE PAN CAPACITY	WELL INTERIOR DIMENSIONS
Table Top Food Bars			
	L x W x H		L x W x D
6FBRTT	181,6 x 84,5 x 68,6 cm	5	159,7 x 51,1 x 16,5 cm
5FBRTT	161,3 x 84,5 x 68,6	4	127,2 x 51,1 x 16,5
4FBRTT	129,5 x 84,5 x 68,6	3	94,6 x 51,1 x 16,5
Buffet Bars			
	L x W x H		L x W x D
BUF72	171,5 x 61 x 17,8	5	159,7 x 51,1 x 12,7
BUF48	106,2 x 61 x 17,8	3	94,6 x 51,1 x 12,7
Free Standing Sneeze Guards			
	L x W x H		L x W
FSG720	187,6 x 41,9 x 62,2	—	171,5 x 38,7
FSG480	121,9 x 41,9 x 62,2	—	106,7 x 38,7
Buffet Bars w/Sneeze Guard			
	L x W x H		L x W x D
BBR720	187,6 x 61,3 x 62,2	5	159,7 x 51,1 x 12,7
BBR480	121,9 x 61,3 x 62,2	3	94,8 x 51,1 x 12,7

Case Pack: 1

SAMPLE FOOD BAR SET-UPS

Visit www.cambro.com/schools for food bar resources, best practices and free posters.



152 cm model



183 cm model

Fresh Food Bars Pre-packaged Breakfast



Rainbow Theme

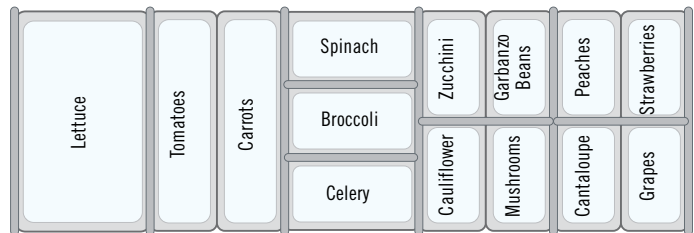

Fresh Food Bars Pre-packaged Lunch



Taco Theme

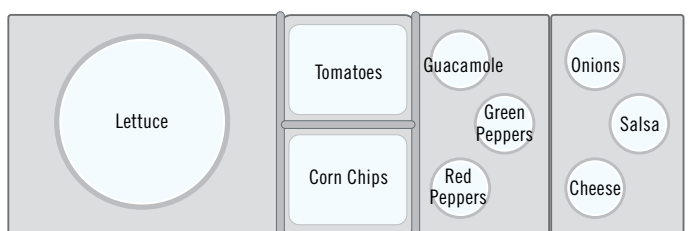

Chili Theme



Burger Theme

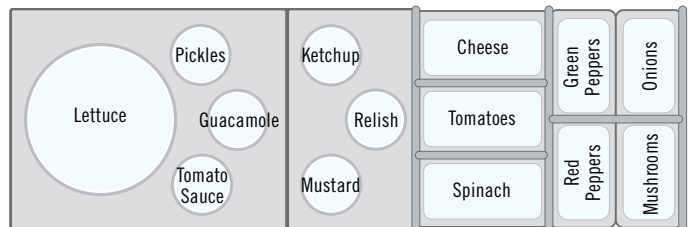

CAMKIOSK® SYSTEM – EVERY EVENT OR LOCATION IS AN OPPORTUNITY FOR PROFITS



- Build sales off premise and in non-traditional locations.
- Two insulated food storage cabinets maintain safe hot or cold food and/or beverage temperatures for hours.
- Use optional well covers to cover food pan wells and increase countertop space.
- Durable, all-weather polyethylene exterior with foam insulation will not crack, dent, bubble, chip, rust or break.
- Heavy duty 15,2 cm casters roll smoothly from kitchen to location then lock in place.

CAMKIOSK® CARTS



Telescoping poles enable canopy to lower 30,5 cm for quick and easy storage.



KVC854C Cart with 4 pan wells & canopy.

Cart Colors

186 Navy Blue

158 Hot Red

Canopy Color

157 Beige

Cart Colors

191 Granite Grey

192 Granite Green

519 Kentucky Green

426 Black Base with Granite Grey Top & Doors

Canopy Color

519 Kentucky Green

Personalize your CamKiosk Cart to promote your brand.

CANOPY TRIM AND TOP PANEL

(Charges per side)

One Color **

Two Color **

Three Color **

FRONT DISPLAY PANEL

(Cruising Café® panel standard)

Set Up Charge per Panel **

Charge per Color **

**Contact your Cambro representative for pricing.



Conveniently located, lockable cash box (included) can also be kept in dry storage compartment.



Camchillers® keep cold packaged foods cold during transport and service when placed directly on top of food pan wells or at the top of the CamKiosk's insulated holding cabinet.

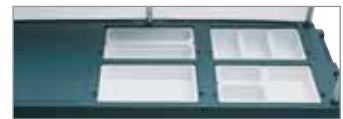

4 well top



6 well top

CODE	FULL SIZE PAN WELLS	OVERALL DIMENSIONS L x W x H
CamKiosk Carts		
KVC854	4	216 x 85 x 179 cm
KVC854C	4	216 x 85 x 239
KVC856	6	216 x 85 x 179
KVC856C	6	216 x 85 x 239

C: Canopy

Holding Capacity Per Compartment

Two holding cabinets store hot or cold food in Gastronorm Food Pans with Covers.

12 GN 1/1 full size 6,5 cm deep pans or

8 GN 1/1 full size 10 cm deep pans or

6 GN 1/1 full size 15 cm deep pans or

4 GN 1/1 full size 20 cm deep pans.

4 each 2025 Camtrays or

8 each 3253 Camtrays.

Well Cover Colors: Black (110),

Hot Red (158), Navy Blue (186),

Kentucky Green (519), Granite Grey (191),

Granite Green (192).

15,24 cm Casters: 2 fixed, 2 swivel,

2 with brake.

Cutting Board Color: White (148).

Camchiller Color: Cold Blue (159).

ThermoBarrier Color: Slate Blue (401).



Camchiller & ThermoBarrier

CODE	DESCRIPTION	DIMENSIONS L x W x H	CASE PACK
Optional Accessories			
CB1220	Cutting board	53,5 x 33,5 x 1,3 cm	1
CP814	20,32 x 35,56 cm Camchiller®	3,81 x 20,32 x 35,56	1
CP1220	Camchiller	53 x 33 x 3,8	1
WCR1220	Well cover	53,5 x 33 x 5	1
1600DIV	ThermoBarrier® insulated shelf	53 x 33,5 x 3,8	2

CAMKIOSK® HAND SINK CART, WORK STATION & EQUIPMENT STAND

Hand Sink Cart

- Self-contained, electric hand washing system can be used alone or with CamKiosk Cart.
- Run hot and cold water for up to 70 hand washings.
- Includes: double sink, two 19 L fresh water tanks, two 28,5 L waste-water bins, hand soap dispenser and paper towel roll holder.
- Durable polyethylene will not crack, dent, bubble, chip or break.
- Hand Sink Cart is designed for hand washing. It contains no filter for purifying water for drinking.
- Faucet is compliant with lead-free regulations.

Colors: Granite Grey (191), Granite Green (192), Navy Blue (186), Hot Red (158), Kentucky Green (519), Black Base with Granite Grey Top & Doors (426).

15,2 cm Casters: 2 fixed, 2 swivel, 2 with brake.

Hand Sink Cart is covered by U.S. Patent 6,173,458 B1.



Water heater and water pump draw a maximum of 11,25 amps and 0,7 amps, respectively. Hand Sink Cart electrical system runs on an average 10 amps.

ADA faucet available. Contact Cambro Customer Service for information.

Hand Sink Cart is designed for hand washing. It contains no filter for purifying water for drinking.

CODE	VOLTAGE	DIMENSIONS L x W x H
KSC402	110V	103 x 84 x 116 cm

Case Pack: 1

Work Station

- Use to merchandise menu items, additional work space or to complete sales transactions.
- Large dry storage cabinet below is perfect for holding supplies.
- Extremely durable all-weather polyethylene will not crack, dent, bubble, chip, rust or break.

Colors: Granite Grey (191), Granite Green (192), Navy Blue (186), Hot Red (158), Kentucky Green (519), Black Base with Granite Grey Top & Doors (426).

15,2 cm Casters: 2 fixed, 2 swivel, 2 with brake.

Top work area dimensions: 57,2 x 66 cm



Shown with optional cutting board and paper towel roll dispenser.

CODE	DESCRIPTION	DIMENSIONS L x W x H
KWS40	Work station	103 x 84 x 116 cm
CB1220	Cutting board	53,5 x 33,5 x 1,3

Case Pack: 1

Equipment Stand

- Perfect for self-serve stations, prep areas or cash register service.
- Counter and side openings for electrical cords and cables.
- Durable, lightweight polyethylene will not crack, dent, bubble, chip, rust or break.
- No assembly required.

Color: Black (110).

12,7 Casters: 2 fixed, 2 swivel with brake.

*Special order item not carried in stock – non-returnable.



Cutaway chair area gives ample space for comfortable seating.

CODE	DESCRIPTION	OVERALL DIM. W x D x H**
ES28	Stand only	71 x 71 x 99 cm
ES28RL*	Stand w/rails on right and left sides of drawer	112 x 71 x 99

**Width includes tray rails. Height includes casters.

CAMCRUISER® VENDING CARTS

- Add revenue opportunities away from the kitchen or cafeteria and reduce wait times.
- Durable polyethylene will not crack, dent, bubble, chip, rust or break.
- Display panel can be personalized with a custom logo or message.
- Larger models CVC724 & CVC72 have insulated food storage compartments and full-size food pan wells.
- Compact model CVC55 has two open storage compartments, a single food pan well, cutting board and umbrella.

Cart Colors	Umbrella Colors
Black (110)	
Hot Red (158)	
Kentucky Green (519)	
Granite Gray (191)	
Granite Green (192)	



CVC724

OPEN COMPARTMENT DIMENSIONS:
W 33,5 x D 61,5 x H 34 cm



CVC72

CVC72 & CVC724



CVC724 Four full size food pan wells. Replace with cutting boards or well covers to create additional work space.



CVC72 One full size food pan well and 2 larger merchandising wells.



Open holding compartment conveniently stores cash box and tray.

CODE	CVC724	CVC72	CVC55
OVERALL DIMENSION* L x W x H	189 x 81 x 239 cm	189 x 81 x 239 cm	140 x 80 x 238 cm
WORK COUNTER HEIGHT	93 cm	93 cm	101 cm
COUNTER WELLS HOLD	4 GN 1/1	Center well, 1 GN 1/1 2 outer wells, L 56 x W 39 x D 15 cm	1 GN 1/1
CLOSED COMPARTMENT CAPACITY (EACH)	2 GN 1/1-20 cm + 2 GN 1/1-6,5 cm deep pans or 4 GN 1/1-15 cm deep pans or 6 GN 1/1-10 cm deep pans or 8 GN 1/1-6,5 cm deep pans or 4 each 2025 Camtrays or 8 each 3253 Camtrays	2 full size 20 cm + 2 GN 1/1-6,5 cm deep pans or 4 GN 1/1-15 cm deep pans or 6 GN 1/1-10 cm deep pans or 8 GN 1/1-6,5 cm deep pans or 4 each 2025 Camtrays or 8 each 3253 Camtrays	—
OPEN COMPARTMENT CAPACITY	1 cash drawer and 1 GN 1/1-15 cm deep pan or 2 GN 1/1-10 cm deep pans or 3 GN 1/1-6,5 cm deep pans	1 cash drawer and 1 GN 1/1-15 cm deep pan or 2 GN 1/1-10 cm deep pans or 3 GN 1/1-6,5 cm deep pans	—
UMBRELLA DIAMETER	183 cm	183 cm	152 cm
CASTERS	20,3 cm - 4 swivel with brake	20,3 cm - 4 swivel with brake	15,2 cm - 2 fixed, 2 swivel with brake
CASH DRAWER	Yes	Yes	—
MENU BOARD	Yes	Yes	—
DISPLAY PANEL	Yes	Yes	Yes
MOLDED IN HANDLES	2	2	1

*Includes Umbrella. Serving counter height is 130 cm.

CAMCRUISER® VENDING CARTS



CVC55

Unit ships with umbrella and cutting board.
Front display panel can be personalized.



Pizza Camcruiser



Sandwich Camcruiser



Hot Dog Camcruiser



Soft Drink Camcruiser

Display Panel Personalization

Provide complete, finished, camera-ready artwork and indicate positioning on display panel.

Ink colors must be specified.
Choose 1-4 colors.

Size of imprinting area:

CVC72 and CVC724
W 53,5 x H 74,5 cm
CVC55 W 112,5 x H 74,5 cm.

Artist's fee of **net/hour will be charged to any order submitted without camera-ready artwork.

Cambro will contact you prior to completing any work if this fee will be charged.

Set up charge of **net per design, plus **net per color.

Allow for three week production lead time once final proofs are approved.

CVC72 and CVC724 - Campus Cuisine display panel standard with all orders unless custom personalization requested.

**Contact your Cambro representative for pricing.

- Cutting Board Color: White (148).
- Camchiller Color: Cold Blue (159).
- Divider Bar Colors: White (148), Clear (135).
- Retainer Strap Color: Black (110).
- ThermoBarrier® Color: Slate Blue (401).
- Well Cover Color matches cart.
- CVC55 is covered by U.S. Patent D 362,102.



Camchiller, ThermoBarrier, and Divider Bar.



Compartments are open for storage and easy access to equipment and supplies for your vending operations. Optional retainer strap is sold separately.

LEFT COMPARTMENT DIMENSIONS:

W 61,5 x D 72,5 x H 70 cm

RIGHT COMPARTMENT DIMENSIONS:

W 54,5 x D 72,5 x H 70 cm

OVERALL DIM. L x W x H

CODE	DESCRIPTION	FITS	OVERALL DIM. L x W x H
Optional Accessories			
CB1220	Cutting board	CVC724, CVC72, CVC55	53,5 x 33,5 x 1,3 cm
CP1220	Camchiller®	CVC724, CVC72	53 x 33 x 3,8
DIV12	Divider bar	CVC724, CVC72, CVC55	32,5 long
WCR1220	Well cover	CVC724, CVC72, CVC55	53,5 x 33 x 5
730STP	Retainer strap	CVC55	—

DIV12 Case Pack: 3 730STP Case Pack: 2 All Others Case Pack: 1
Camchiller, ThermoBarrier & Divider Bar are NSF listed.

CVC55



Set up with full and fractional size food pans and divider bars to increase product offerings.



Electrical or soda line conveniently drops through 10 x 17 cm opening in counter. Cover is standard with cart.

CAMSHELVING® FLEX STATION

- Reduce serving time and give kids time to eat by setting up portable Grab-N-Go stations in convenient locations.
- Ideal for use for breakfast to go, fresh fruit and vegetable programs, boosting a la carte sales and supper or summer feeding programs.
- Use black Camwear® GN pans and angled divider bars to provide a modern look and easy access to items.



New!

Camshelving Elements



New!

Camshelving Premium

CODE	DESCRIPTION	DIMENSIONS D x L x H	QUANTITY EACH
Package EMU244870FXPKG Includes			
EMPK2470	Mobile post kits with casters	610 x 1220 x 1778 mm	2
EMTR482PK	Mobile traverses	1220	4
EDBA	Angled divider bars	610	36
CSID6	Identification tags	25 x 152	24
Optional Accessories			
EMSK2448S1	Solid shelf kit	610 x 1220	1
12189CW135	Clear Camwear food box	305 x 460 x 230	12
1218SCCW135	Clear Camwear SlidingLid™	305 x 460	12
CP814159	Compact Camchiller®	L 355,6 x W 203,2 x H 38	12

CODE	DESCRIPTION	DIMENSIONS D x L x H	QUANTITY EACH
Package CPMU244867FXPKG Includes			
CPMPK2467	Mobile post kits with casters	610 x 1220 x 1778 mm	2
CPTR482PK	Traverses	1220	4
CSDBA	Angled divider bars	610	36
CSID6	Identification tags	25 x 152	24
Optional Accessories			
CPSK2448S1	Solid shelf kit	610 x 1220	1
16CW110	Black Camwear food pans	325 x 530	12
CP814159	Compact Camchillers	L 355,6 x W 203,2 x H 38	12



Angled Divider Bars

Securely hold food pans and boxes in place allowing easy access.



Camwear Food Storage Box

Shatterproof and durable, clear box allows for content visibility. Ideal for serving bulk fruits and vegetables during the day and keeping them fresh in a cooler or freezer overnight.



Camwear Food Pans

Store, transport, and serve all in one pan. Durable black food pans provide a sleek, modern look and are easy to clean and store when not in use.



Compact Camchiller

Keep temperature sensitive items cool for hours with Camchillers. Reduce the risk of cross contamination by eliminating the use of ice.

BOOSTER SEATS & VERSA ORGANIZERS

Booster Seats

- Contoured seat, high sides, wide square base and non-skid surface for toddler comfort and safety.
- Choose from dual or single seat models, with or without strap.
- Durable polyethylene will not crack, dent, bubble, chip, rust or break.

Colors: Black (110), Dark Brown (131), Coffee Beige (157), Navy Blue (186), Kentucky Green (519), Hot Red (158).

No broken cartons on 4 pack.



A Single Seat

B Dual Seat

DIMENSIONS	W x D x H
Overall	29,5 x 28,6 x 20,6 cm
Seat Base	22,2 x 24,7
Inside Seat	24,1 x 24,7 x 10,2

CODE	100BC	100BC1	100BCS
Single Seat			
DESCRIPTION	no strap	no strap	with strap
CASE PACK	4	1	4



Booster seats are available with or without straps.

DIMENSIONS	W x D x H
Overall	31,6 x 31,1 x 23,8 cm
Seat Base A	31,6 x 31,1
Seat Base B	32,1 x 30,8
Inside Seat A	21 x 24,4 x 8,3
Inside Seat B	27,3 x 27,3 x 12,1

CODE	200BC	200BC1	200BCS
Double Seat			
DESCRIPTION	no strap	no strap	with strap
CASE PACK	4	1	4

Versa Organizers

- Use to store non-perishable condiments, disposable ware and napkins.
- Hold bins in 2 x 3, 2 x 4, 3 x 3, or 3 x 4 arrangements.
- Made of seamless, one-piece polyethylene.
- Set on flat surface or wall mount each bin holds up to 4,5 kg.
- Easy to assemble and easy to clean.

Bins only colors: Dark Brown (131), Black (110), Slate Blue (401), Speckled Grey (480).

Versa line combined pack bins & racks.

Colors: Black (110), Speckled Grey (480).



STOCK PRODUCTS & COLORS AVAILABLE IN OUR EUROPEAN WAREHOUSE

5412CBP: (131), (480)
6RS6: (480)



12RS12 Versa Organizer shown mounted on wall.



Bins sold separately (5412CBP) or as combined packs.



8RS8



6RS6

CODE	DESCRIPTION	PRODUCT DIMENSIONS	CASE PACK
Bins		W x D x H	
5412CBP		13 x 30,5 x 11 cm	12
Versa Line Combined Pack		L x D x H (complete unit)	
12RS12	Rack w/12 bins	64,8 x 54,3 x 36,2	1
9RS9	Rack w/9 bins	51,1 x 54,3 x 36,2	1
8RS8	Rack w/8 bins	64,8 x 48,8 x 24,1	1
6RS6	Rack w/6 bins	51,1 x 48,8 x 24,1	1



PORTABLE CAMBARS®

- Stylish, portable beverage bars for hosting in any environment.
- Select from three systems: economy for bottle and can service, partial or complete soda gun set up systems for pre-mix (canisters) or post-mix (bag-in-box).
- Available in three sizes:
 - Large BAR730 is perfect for banquets and cocktail events.
 - Mid-size BAR650 fits into standard elevators and is ideal for small to mid-size functions.
 - Small BAR540 is ultra portable for off-premise use and events with limited space.
- All models include speed rail and 36,3 kg capacity ice sink with cover. BAR540 sink comes uncovered.
- Impact-resistant, waterproof polyethylene will not crack, dent, bubble, chip, rust or break.
- Lightweight and portable.
- Easy to take apart and clean, easy to set up.





BAR650 Shown in Standard Decor Granite Sand (194).



BAR650DS Shown in Designer Decor Sedona (668).

THREE SIZES

THREE SYSTEMS

	ECONOMY SYSTEM	BASIC SYSTEM	COMPLETE SYSTEM
<p>Large BAR730 Models</p> 	<ul style="list-style-type: none"> • For Bottle, Can, or Mixer Service. • Includes Ice Bin & Speed Rail. • Standard or Designer Decor. 	<ul style="list-style-type: none"> • Partially Equipped for Post or Pre-Mix Soda Service. • Operator Completes Installation. • Standard or Designer Decor. 	<ul style="list-style-type: none"> • Completely Factory Equipped for Post or Pre-Mix Soda Service. • Standard or Designer Decor.
<p>Standard Decor BAR730</p> <p>Designer Decor BAR730DS</p>	<p>Standard Decor BAR730CP</p> <p>Designer Decor BAR730DSCP</p>	<p>Standard Decor BAR730PM, BAR730PMT, BAR730PMT220, BAR730DX</p> <p>Designer Decor BAR730DSPM, BAR730DSPMT, BAR730DSPMT2, BAR730SDX</p>	
<p>Mid-Size BAR650 Models</p> 	<p>Standard Decor BAR650</p> <p>Designer Decor BAR650DS</p>	<p>Standard Decor BAR650CP</p> <p>Designer Decor BAR650DSCP</p>	<p>Standard Decor BAR650PM, BAR650PMT, BAR650PMT220, BAR650DX</p> <p>Designer Decor BAR650DSPM, BAR650DSPMT, BAR650DSPMT2, BAR650SDX</p>
<p>Small BAR540 Models</p> 	<p>Standard Decor BAR540</p> <p>Designer Decor BAR540DS</p>	<p>—</p> <p>—</p>	<p>—</p> <p>—</p>

PORTABLE CAMBARS® PACKAGES & ACCESSORIES

STANDARD EQUIPMENT, SODA GUNS, STANDARD AND DESIGNER DECOR PACKAGES

STANDARD DECOR EQUIPMENT	ECONOMY			BASIC SYSTEM			COMPLETE SYSTEM POST-MIX (Bag in Box)				COMPLETE SYSTEM PRE-MIX (Canisters)	
	BAR540	BAR650	BAR730	BAR650CP	BAR730CP	BAR650PM	BAR650PMT	BAR730PM	BAR730PMT	BAR650DX	BAR730DX	
DESIGNER DECOR EQUIPMENT	BAR540DS	BAR650DS	BAR730DS	BAR650DSCP	BAR730DSCP	BAR650DSPM	BAR650DSPMT	BAR730DSPM	BAR730DSPMT	BAR650DSDX	BAR730DSDX	
Bag In Box Syrup Pumps						3 ea	3 ea	6 ea	6 ea			
Bag In Box Rack (Holds 3 ea. Boxes)						1	1	2	2			
Carbonator						YES	YES	YES	YES			
CO ₂ Regulator						YES	YES	YES	YES	YES	YES	
CO ₂ Clamp & Chain				YES	YES	YES	YES	YES	YES	YES	YES	
8 Circuit Cold Plate in Ice Sink				YES	YES	YES	YES	YES	YES	YES	YES	
Ice Sink Cover	Sink only	YES	YES	YES	YES	YES	YES	YES	YES	YES	YES	
Retainer Strap		1	2	1	2	1	1	2	2	1	2	
Soda Gun (5, 6 or 8 buttons)						5	5	8	8	5	6	
Speed Rail (5 or 7 bottle)	5	7	7	7	7	7	7	7	7	7	7	
Water Pump						YES	YES	YES	YES			
Water Tank							YES		YES			
Water Line Hook Up (city source)						YES	YES	YES	YES			
Waste Water Bin		YES	YES	YES	YES	YES	YES	YES	YES	YES	YES	
Vinyl Cover	YES	YES	YES	YES	YES	YES	YES	YES	YES	YES	YES	

Casters: All BAR540 Models - Four 12,7 cm swivel, two with brake. All BAR650 and BAR730 Models - Four 15,24 cm swivel, two with brake.

Soda Guns by Wunder-Bar®

- Fast, low foaming delivery.
- Two year warranty from Wunder-Bar.
- Includes holster with overflow drain.
- Available with complete systems only.



Post-Mix 8 Button
(BAR730 Complete System)



Post-Mix 5 Button
(BAR650 Complete System)



Pre-Mix 6 Button
(BAR730 Complete System)



Pre-Mix 5 Button
(BAR650 Complete System)

Standard Decor Colors BAR540, BAR650, BAR730



110
Black



191
Granite Gray



194
Granite Sand

BAR650, BAR730 Only

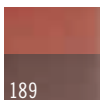

189
Two-Tone Brown
Mahogany



420
Granite Gray
w/ Black Base

BAR540 Only



131
Dark Brown

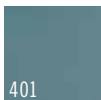

401
Slate Blue

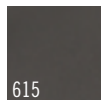

615
Charcoal Gray

Designer Decor BAR650, BAR730 Only



667
Manhattan

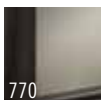

770
Chicago

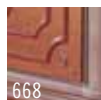

668
Sedona



669
Carmel

BAR540 Designer Decor color options are listed with BAR540 details.

Exclusive Cold Plate

- Patented “roof top” design allows for melted ice water to drain into the bottom of the ice sink and into the waste-water bin.
- Circuit exposure through cold plate chills liquids dispensed from the soda gun.



Cold Plate is covered under
U.S. Patent 5,743,602.

Optional Accessories for CamBars

CODE	DESCRIPTION
650WS	Wire shelf for BAR650's
730WS	Wire shelf for BAR730's
730SR	7 bottle speed rail
BAR54SR	5 bottle speed rail

Case Pack: 1

730SR Speed Rail Colors: Black (110), Dark Brown (131), Granite Gray (191).

BAR54SR Speed Rail Colors: Black (110), Dark Brown (131), Granite Gray (191), Granite Sand (194), Slate Blue (401).

CAMBAR® POST-MIX SYSTEM FEATURES

Designed for Peak Functionality

- Soda gun and GFI-protected 110V outlet are ergonomically positioned for convenient operator access and maximized workspace.
- NSF listed beverage line with Flushable Glas-Flex™ liner for easy flushing and changing of even the strongest flavors.
- Hygienic and easy-to-clean.

Front

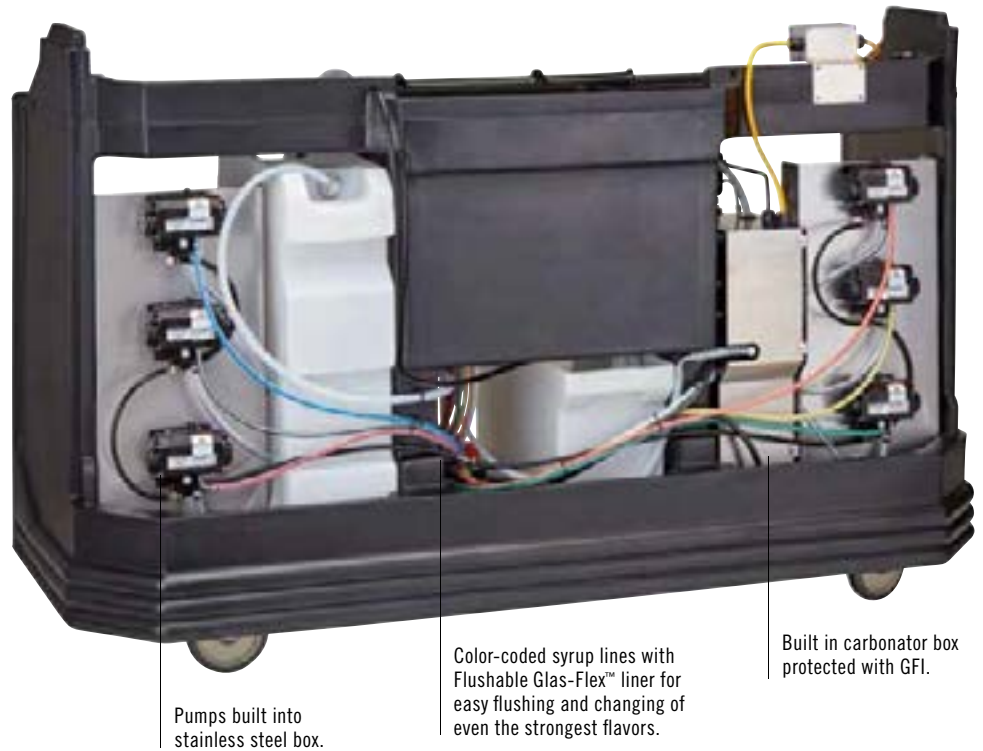

Back

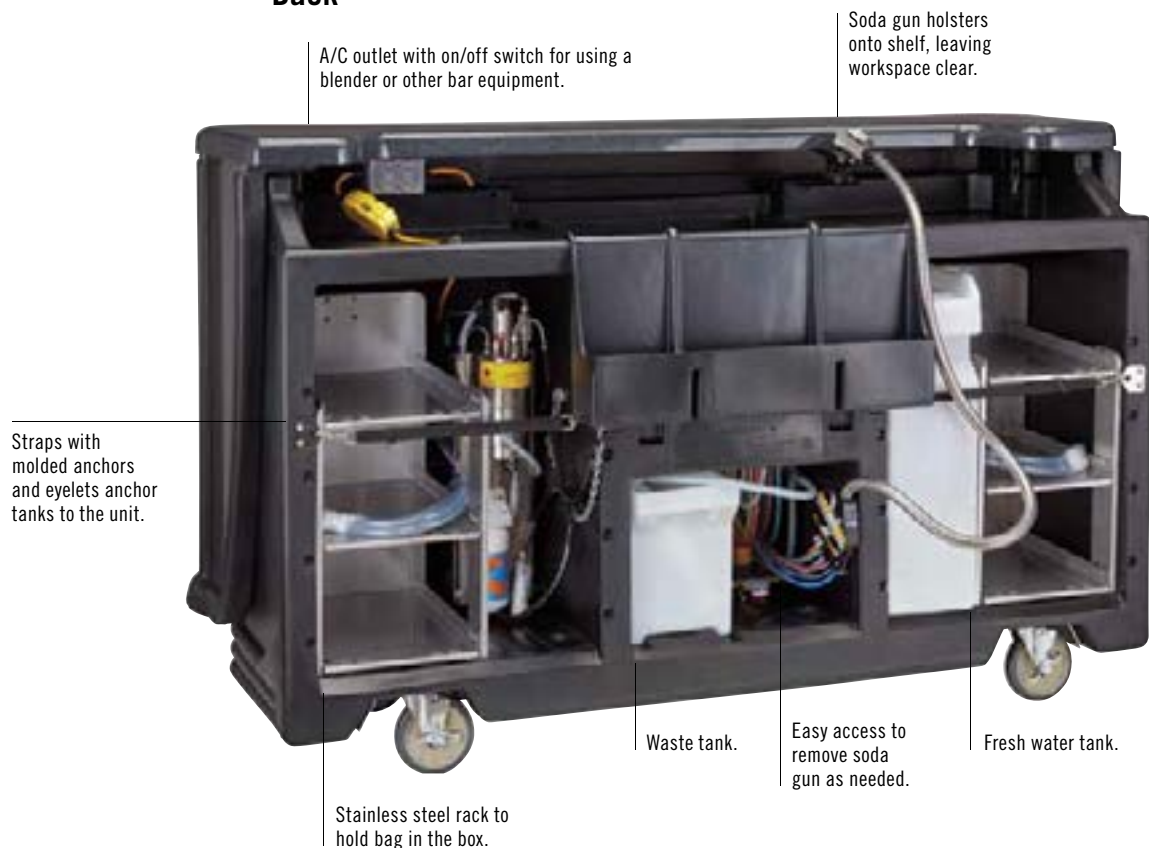

LARGE CAMBARS® – COMPLETE SYSTEMS BAR730

Post-mix System for 18,9 L, Bag-in-box Syrups
Holds up to 6 syrup boxes and 1 CO₂ tank.

BAR730PM and BAR730DSPM

Includes the standard equipment from the Basic System plus:

- Post-mix soda gun with 8 buttons.
- Carbonator.
- 2 stainless steel bag-in-box wire racks.
- 6 bag-in-box pumps.
- CO₂ regulator gauge & tubing, hose & lines.
- Line for city water hook-up.

BAR730PMT, BAR730DSPMT, BAR730PMT220 and BAR730DSPMT2

Includes all of the above plus 1, 64,3 L water tank and 1 water pump.
Line for city water hook-up is not included.



BAR730SDSX Shown in Designer Decor Carmel (669).



Cold Plate



BAR730DSPMT
Shown with water tank and bag-in-box racks.



Pump and Carbonator

CODE	VOLTS	WATER TANK	DIMENSIONS L x W x H	UNIT WEIGHT
Standard Decor				
BAR730PM	110	No	184,8 x 66 x 121,9 cm	152 kg
BAR730PMT	110	Yes	184,8 x 66 x 121,9	157
BAR730PMT220	220	Yes	184,8 x 66 x 121,9	157
Designer Decor				
BAR730DSPM	110	No	197,2 x 72,4 x 120,7	176
BAR730DSPMT	110	Yes	197,2 x 72,4 x 120,7	181
BAR730DSPMT2	220	Yes	197,2 x 72,4 x 120,7	181



Vinyl cover included with all CamBars.
Cover not NSF listed.

Pre-mix System for 18,9 L Soda Canisters
Holds up to 7 canisters and 1 CO₂ tank.

BAR730DX and BAR730SDSX

Includes the standard equipment from the Basic System plus:

- Pre-mix soda gun with 6 buttons.

CODE	WATER TANK	DIMENSIONS L x W x H	UNIT WEIGHT
Standard Decor			
BAR730DX	No	184,8 x 66 x 121,2 cm	133 kg
Designer Decor			
BAR730SDSX	Yes	197,2 x 72,4 x 120,7	151



Cold Plate



BAR730DX

LARGE CAMBARS® – ECONOMY AND BASIC SYSTEMS BAR730

Basic System BAR730 Partially Equipped for Soda Service

Requires customer installation of pre-mix or post-mix soda gun system.

Includes:

- Sealed-in cold plate w/8 circuits.
- CO₂ chain.
- 7-bottle speed rail.
- 36,3 kg capacity ice sink.
- Ice sink cover.
- Waste-water bin.
- 2 retainer straps.
- 4, 15,2 cm swivel casters, 2 with brake.
- Vinyl cover.



Cold Plate



BAR730DSCP
Shown with four optional wire racks; see details under Portable CamBar Packages & Accessories.

CODE	DIMENSIONS L x W x H	UNIT WEIGHT
Standard Decor		
BAR730CP	184,8 x 66 x 121,9 cm	132 kg
Designer Decor		
BAR730DSCP	197,2 x 72,4 x 120,7	146

Economy System BAR730 For Bottle, Can or Mixer Service

Includes:

- 7-bottle speed rail.
- 36,3 kg capacity ice sink.
- Ice sink cover.
- Waste-water bin.
- 2 retainer straps.
- 4, 15,2 cm swivel casters, 2 with brake.
- Vinyl cover.

CODE	DIMENSIONS L x W x H	UNIT WEIGHT
Standard Decor		
BAR730	184,8 x 66 x 121,9 cm	90 kg
Designer Decor		
BAR730DS	197,2 x 72,4 x 120,7	111,2



MID-SIZE CAMBARS® – COMPLETE SYSTEMS BAR650

Post-mix System for 18,9 L Bag-in-box Syrups
Holds up to 3 syrup boxes and 1 CO₂ tank.

BAR650PM and BAR650DSPM

Includes the standard equipment from the Basic System plus:

- Post-mix soda gun with 5 buttons.
- Carbonator.
- Stainless steel bag-in-box wire rack.
- 3 bag-in-box pumps.
- CO₂ regulator gauge & tubing, hose & lines.
- Line for city water hook-up.
- Water pump.
- Water filter.

BAR650PMT, BAR650DSPMT, BAR650PMT220 and BAR650DSPMT2

Includes all of the above plus 1, 64,3 L water tank and 1 water pump.
Line for city water hook-up is not included.

CODE	VOLTS	WATER TANK	DIMENSIONS L x W x H	UNIT WEIGHT
Standard Decor				
BAR650PM	110	No	171,5 x 72,4 x 120,7 cm	137 kg
BAR650PMT	110	Yes	171,5 x 72,4 x 120,7	142
BAR650PMT220	220	Yes	171,5 x 72,4 x 120,7	142
Designer Decor				
BAR650DSPM	110	No	171,5 x 72,4 x 120,7	158
BAR650DSPMT	110	Yes	171,5 x 72,4 x 120,7	163
BAR650DSPMT2	220	Yes	171,5 x 72,4 x 120,7	163



Cold Plate



Pump and Carbonator

BAR650DSPMT
Shown with water tank and bag-in-box rack.

Pre-mix System for 18,9 L Soda Canisters
Holds up to 5 canisters and 1 CO₂ tank.

BAR650DX and BAR650SDSX

Includes the standard equipment from the Basic System plus:

- Pre-mix soda gun with 5 buttons.

CODE	DIMENSIONS L x W x H	UNIT WEIGHT
Standard Decor		
BAR650DX	171,5 x 72,4 x 120,7 cm	120,3 kg
Designer Decor		
BAR650SDSX	171,5 x 72,4 x 120,7	142



Cold Plate



BAR650SDSX

MID SIZE AND SMALL CAMBARS® – ECONOMY AND BASIC SYSTEMS

Basic System BAR650 – Mid-Size Model Partially Equipped for Soda Service

Requires customer installation of pre-mix or post-mix soda gun system.

- Includes:**
- Sealed-in cold plate with 8 circuits.
 - CO₂ chain.
 - 7-bottle speed rail.
 - 36,3 kg capacity ice sink.
 - Ice sink cover.
 - Waste-water bin.
 - Retainer strap.
 - 4, 15,2 cm swivel casters, 2 with brake.
 - Vinyl cover.

CODE	DIMENSIONS L x W x H	UNIT WEIGHT
Standard Decor		
BAR650CP	171,5 x 72,4 x 120,7 cm	129,3 kg
Designer Decor		
BAR650DSCP	171,5 x 72,4 x 120,7	137



Cold Plate

BAR650DSCP
Shown with two optional wire racks; see details under Portable CamBar Packages & Accessories.

Economy System BAR650 – Mid-Size Model For Bottle, Can or Mixer Service

- Includes:**
- 7-bottle speed rail.
 - 36,3 kg capacity ice sink.
 - Ice sink cover.
 - Waste-water bin.
 - Retainer strap.
 - 4, 15,2 cm swivel casters, 2 with brake.
 - Vinyl cover.

CODE	DIMENSIONS L x W x H	UNIT WEIGHT
Standard Decor		
BAR650	171,5 x 72,4 x 120,7 cm	78,5 kg
Designer Decor		
BAR650DS	171,5 x 72,4 x 120,7	100



BAR650DS
Shown with two optional wire racks; see details under Portable CamBar Packages & Accessories.

Economy System BAR540 – Small Model For Bottle, Can, or Mixer Service

- Includes:**
- 5-bottle speed rail.
 - 36,3 kg capacity ice sink.
 - 4, 12,7 cm swivel casters, 2 with brake.
 - Vinyl cover.

CODE	DIMENSIONS L x W x H	UNIT WEIGHT
Standard Decor		
BAR540	137,2 x 65,7 x 117,2 cm	53,1 kg
Designer Decor		
BAR540DS	137,2 x 65,7 x 117,2	56



BAR540DS

Designer Decor Colors

BAR540 Only

670 Black Base w/ Coal Counter

671 Granite Gray Base w/ Slate Gray Counter

672 Granite Sand Base w/ Cocoa Counter

SLIDINGLID™ ICE CADDIES

- Polyethylene body and thick foam insulation hold ice for days.
- Rugged, all-weather exterior will not crack, dent, bubble, chip, rust or break.
- Unique sliding lid slides back and under during use, reducing risk of cross-contamination.
- Recessed well and drain shelf keep ice out of water, extending holding times.
- Recessed, molded-in handles ease lifting and maneuvering.
- Slant top sliding lid units fit under prep/catering tables and counters.



ICS175LB
(Short) Shown with Rear Easy Wheels.



ICS125L
(Short)



ICS100L4S
(Short)

ICS100L
(Short)



ICS175T
(Tall)

Colors: Black (110), Slate Blue (401), Dark Brown (131), Coffee Beige (157), Granite Grey (191).

SlidingLid Ice Caddies ICS125L, ICS125L4S, ICS125LB are covered by US Patent D 468,071 S. SlidingLid Ice Caddies ICS100L and ICS100L4S are covered by US Patent D 424,883.



STOCK PRODUCTS & COLOR AVAILABLE IN OUR EUROPEAN WAREHOUSE

ICS100L, ICS125L: (191)



ICS175TB
(Tall) Shown with Rear Easy Wheels.



StoreSafe
STORE FRESH

Caster Descriptions

Refers to caster type in chart.
All casters are 12,7 cm.

A: 2 fixed, 2 swivel, 1 with brake

A1: 2 swivel, 2 with brakes

B: 4 swivel, 1 with brake

C: 2 swivel, 1 with brake,
2 20,3 cm Easy Wheels

D: 2 swivel, 1 with brake,
2 25,4 cm Easy Wheels

E: 2 swivel, 1 with brake,
2 25,4 cm Wide Easy Wheels



ICS200TB
(Tall) Shown with Rear Wide Easy Wheels.



CODE	CAPACITY	EXTERIOR DIMENSIONS W x D x H	CASTER TYPE
Short			
ICS100L	46 kg	57 x 77 x 73 cm	A1
ICS100L4S	46	57 x 77 x 73	B
ICS125L	57	58,5 x 80 x 74,5	A
ICS125LB	57	58,5 x 80 x 74,5	C
ICS175L	80	61 x 95,5 x 74,5	A
ICS175LB	80	61 x 95,5 x 74,5	D
Tall			
ICS125T	57	58,5 x 80 x 88	A
ICS175T	80	58,5 x 86,5 x 95,5	A
ICS175TB	80	58,5 x 86,5 x 95,5	D
ICS200TB	91	58,5 x 86,5 x 100,5	E

Case Pack: 1



WAREWASHING, HANDLING & STORAGE

Camrack® 4-in-1 Warewashing System

Camdollies®

Utility Trucks

Tray & Dish Cart / Tray & Silverware Cart

S-Series Adjustable Dish Caddy

ADC33 Adjustable Dish Caddy

Dish Caddies, Adjustable Tray & Dish Cart

Cambox® Bus Boxes

KD Service Cart and KD Utility Cart

Service Carts



CAMRACK® 4-IN-1 WAREWASHING SYSTEM

The Camrack System will protect glassware and keep it clean until the next event, eliminating the need for rewashing.

Efficient Washing

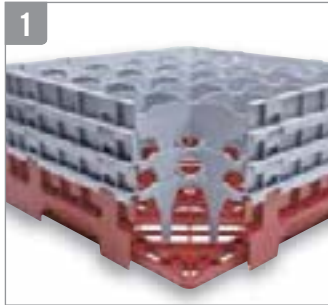

Open inside compartments provide thorough circulation of water and cleaning solutions and promote quick and thorough drying.

Long-lasting polypropylene Camracks are built to withstand chemicals and high temperatures up to 93°C.

Sanitary Storage



Closed outer walls keep fingers and contaminants out and reduce risk of breakage and injury. The Camrack cover and Camdolly make this system completely enclosed. Glassware stays clean when in storage, so operators will only have to wash items once.

Inventory Control



A variety in base rack colors help identify at a glance both contents and quantity per rack. Available in 10 colors.

Safe, Sanitary Transportation



Camracks can be transported across large campuses or to off-site locations in one single unit.

Easy to grip handles and smooth overlapping sides facilitate safe handling.

Camrack Cover Seals from the Top and Camdolly® Seals from the Bottom.



Camracks interstack with racks from major manufacturers.



Content labeling options include one-color custom hot stamping or pre-printed clips.



Camracks are covered by one or more of the following patents: Full Base Dish Rack D 412,607. Half Base Dish Rack D 404,176. Half Dish Rack Extender D 400,321. Enlarged Dish Rack Extender D 399,614. Dish Rack with Extender 5,934,486 Utility Patent. Pronged Base Dish Rack D 403,472.

FULL SIZE CAMRACKS® FOR STEMWARE & TUMBLERS

These racks offer complete protection for all your delicate and valuable stemware and tumblers, from washing and handling to stacking, storing and transporting.

Choose the correct dishrack:

1. Measure the maximum diameter of your glass (stemware or tumbler) to determine the number of compartments.
2. Measure the maximum height of your glass (stemware or tumbler) to the top edge of the rim to determine the compartment height.

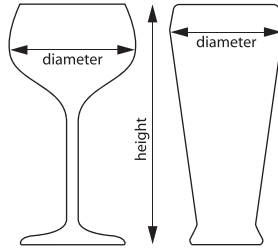

STOCK PRODUCTS & COLORS AVAILABLE IN OUR EUROPEAN WAREHOUSE

ALL CAMRACKS: (110), (119), (151), (163), (167), (168), (184), (186), (414), (416)



25S534

Camrack Sizing Guides are available at www.cambro.com/mycamracks and on the Cambro App.

14,9 cm
MAXIMUM DIAMETER



9 COMPARTMENT

MAXIMUM HEIGHT	9,2 cm	13,3 cm	17,4 cm	21,5 cm	25,7 cm	29,8 cm
CODE	9S318	9S434	9S638	9S800	9S958	9S1114
CASE PACK	5	4	3	2	2	2
EXT. RACK HEIGHT	14,3 cm	18,4 cm	22,5 cm	26,7 cm	30,8 cm	34,9 cm

11,11 cm
MAXIMUM DIAMETER

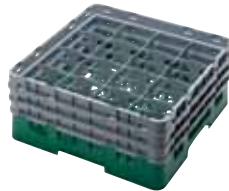

16 COMPARTMENT

MAXIMUM HEIGHT	9,2 cm	11,4 cm	13,3 cm	15,5 cm	17,4 cm	19,6 cm
CODE	16S318	16S418**	16S434	16S534**	16S638	16S738**
CASE PACK	5	5	4	4	3	3
EXT. RACK HEIGHT	14,3 cm	14,3 cm	18,4 cm	18,4 cm	22,5 cm	22,5 cm
MAXIMUM HEIGHT	21,5 cm	23,8 cm	25,7 cm	27,9 cm	29,8 cm	32 cm
CODE	16S800	16S900**	16S958	16S1058**	16S1114	16S1214**
CASE PACK	2	2	2	2	2	2
EXT. RACK HEIGHT	26,7 cm	26,7 cm	30,8 cm	30,8 cm	34,9 cm	34,9 cm

Base Rack Colors:

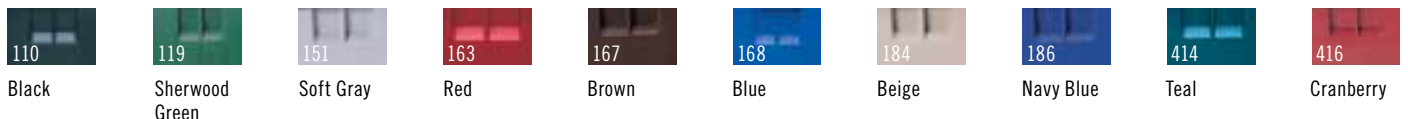

Extender Color: Soft Grey (151). **Compartment Extenders cannot be added. Personalization available. See Camrack personalization and color coding page. For a more accurate color representation, call your sales rep for actual color chips. Contact Customer Service for all special orders.

FULL SIZE CAMRACKS® FOR STEMWARE & TUMBLERS

Match a glass to a rack at www.cambro.com/Reference_Guides.

9,84 cm
MAXIMUM DIAMETER



20 COMPARTMENT

MAXIMUM HEIGHT	9,2 cm	11,4 cm	13,3 cm	15,5 cm	17,4 cm	19,6 cm
CODE	20S318	20S418**	20S434	20S534**	20S638	20S738**
CASE PACK	5	5	4	4	3	3
EXT. RACK HEIGHT	14,3 cm	14,3 cm	18,4 cm	18,4 cm	22,5 cm	22,5 cm
MAXIMUM HEIGHT	21,5 cm	23,8 cm	25,7 cm	27,9 cm	29,8 cm	32 cm
CODE	20S800	20S900**	20S958	20S1058**	20S1114	20S1214**
CASE PACK	2	2	2	2	2	2
EXT. RACK HEIGHT	26,7 cm	26,7 cm	30,8 cm	30,8 cm	34,9 cm	34,9 cm

**Compartment Extenders cannot be added.

8,7 cm
MAXIMUM DIAMETER



25 COMPARTMENT

MAXIMUM HEIGHT	9,2 cm	11,4 cm	13,3 cm	15,5 cm	17,4 cm	19,6 cm
CODE	25S318	25S418**	25S434	25S534**	25S638	25S738**
CASE PACK	5	5	4	4	3	3
EXT. RACK HEIGHT	14,3 cm	14,3 cm	18,4 cm	18,4 cm	22,5 cm	22,5 cm
MAXIMUM HEIGHT	21,5 cm	23,8 cm	25,7 cm	27,9 cm	29,8 cm	32 cm
CODE	25S800	25S900**	25S958	25S1058**	25S1114	25S1214**
CASE PACK	2	2	2	2	2	2
EXT. RACK HEIGHT	26,7 cm	26,7 cm	30,8 cm	30,8 cm	34,9 cm	34,9 cm

**Compartment Extenders cannot be added.

7,94 cm
MAXIMUM DIAMETER



30 COMPARTMENT

MAXIMUM HEIGHT	9,2 cm	13,3 cm	17,4 cm	21,5 cm	25,7 cm	29,8 cm
CODE	30S318	30S434	30S638	30S800	30S958	30S1114
CASE PACK	5	4	3	2	2	2
EXT. RACK HEIGHT	14,3 cm	18,4 cm	22,5 cm	6,7 cm	30,8 cm	4,9 cm

**STOCK PRODUCTS & COLORS
AVAILABLE IN OUR EUROPEAN
WAREHOUSE**

ALL CAMRACKS: (110), (119), (151), (163), (167), (168), (184), (186), (414), (416)

FULL SIZE CAMRACKS® FOR STEMWARE & TUMBLERS

7,3 cm
MAXIMUM DIAMETER



36 COMPARTMENT

MAXIMUM HEIGHT	9,2 cm	11,4 cm	13,3 cm	15,5 cm	17,4 cm	19,6 cm
CODE	36S318	36S418**	36S434	36S534**	36S638	36S738**
CASE PACK	5	5	4	4	3	3
EXT. RACK HEIGHT	14,3 cm	14,3 cm	18,4 cm	18,4 cm	22,5 cm	22,5 cm
MAXIMUM HEIGHT	21,5 cm	23,8 cm	25,7 cm	27,9 cm	29,8 cm	32 cm
CODE	36S800	36S900**	36S958	36S1058**	36S1114	36S1214**
CASE PACK	2	2	2	2	2	2
EXT. RACK HEIGHT	26,7 cm	26,7 cm	30,8 cm	30,8 cm	34,9 cm	34,9 cm

6,2 cm
MAXIMUM DIAMETER



49 COMPARTMENT

MAXIMUM HEIGHT	9,2 cm	13,3 cm	17,4 cm	21,5 cm	25,7 cm	29,8 cm
CODE	49S318	49S434	49S638	49S800	49S958	49S1114
CASE PACK	5	4	3	2	2	2
EXT. RACK HEIGHT	14,3 cm	18,4 cm	22,5 cm	26,7 cm	30,8 cm	34,9 cm

STOCK PRODUCTS & COLORS AVAILABLE IN OUR EUROPEAN WAREHOUSE

ALL CAMRACKS: (110), (119), (151), (163), (167), (168), (184), (186), (414), (416)



Base Rack Colors:

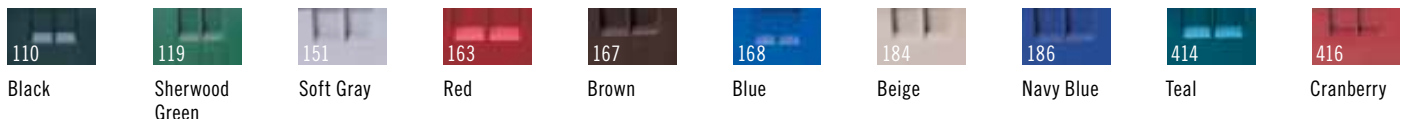

Extender Color: Soft Grey (151). **Compartment Extenders cannot be added. Personalization available. See Camrack personalization and color coding page. For a more accurate color representation, call your sales rep for actual color chips. Contact Customer Service for all special orders.

HALF SIZE CAMRACKS® FOR STEMWARE & TUMBLERS

- Very effective for carrying less weight and for storing drinkware in space-restricted locations.
- Ideal for small under-counter glasswashers.

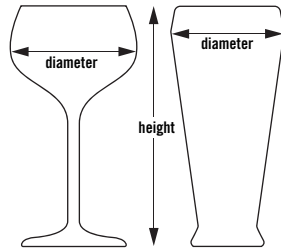

Match a glass to a rack at www.cambro.com/Reference_Guides.

8 COMPARTMENT

10,3 cm
MAXIMUM DIAMETER



MAXIMUM HEIGHT	9,2 cm	13,3 cm	17,4 cm	21,5 cm	25,7 cm	29,8 cm
CODE	8HS318	8HS434	8HS638	8HS800	8HS958	8HS1114
CASE PACK	5	4	3	2	2	2
EXT. RACK HEIGHT	14,3 cm	18,4 cm	22,5 cm	26,7 cm	30,8 cm	34,9 cm

10 COMPARTMENT

8,7 cm
MAXIMUM DIAMETER



MAXIMUM HEIGHT	9,2 cm	13,3 cm	17,4 cm	21,5 cm	25,7 cm	29,8 cm
CODE	10HS318	10HS434	10HS638	10HS800	10HS958	10HS1114
CASE PACK	5	4	3	2	2	2
EXT. RACK HEIGHT	14,3 cm	18,4 cm	22,5 cm	26,7 cm	30,8 cm	34,9 cm

17 COMPARTMENT

7,3 cm
MAXIMUM DIAMETER



MAXIMUM HEIGHT	9,2 cm	13,3 cm	17,4 cm	21,5 cm	25,7 cm	29,8 cm
CODE	17HS318	17HS434	17HS638	17HS800	17HS958	17HS1114
CASE PACK	5	4	3	2	2	2
EXT. RACK HEIGHT	14,3 cm	18,4 cm	22,5 cm	26,7 cm	30,8 cm	34,9 cm

Base Rack Colors:



Sherwood Green



Soft Grey

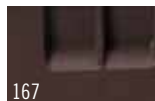

Brown



Beige



Navy Blue



Cranberry

Extender Color: Soft Grey (151). Personalization available. See Camrack personalization and color coding page. For a more accurate color representation, call your sales rep for actual color chips. Contact Customer Service for all special orders.

CAMRACK® FULL & HALF SIZE CUP RACKS

- Tilt feature drains water from mug or cup bases for quick and sanitary drying.

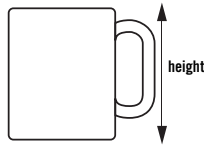

16C414

11,1 x 10,95 cm

COMPARTMENT DIMENSIONS



16 COMPARTMENT

	MAXIMUM HEIGHT	6,6 cm	10,7 cm	14,9 cm
CODE		16C258	16C414	16C578
CASE PACK		6	5	4
EXT. RACK HEIGHT		10,1 cm	14,3 cm	18,4 cm

STOCK PRODUCTS & COLORS AVAILABLE IN OUR EUROPEAN WAREHOUSE

16C258, 16C414, 16C578, 20C258, 20C414: (151)



11,1 x 8,73 cm

COMPARTMENT DIMENSIONS



20 COMPARTMENT

	MAXIMUM HEIGHT	6,6 cm	10,7 cm
CODE		20C258	20C414
CASE PACK		6	5
EXT. RACK HEIGHT		10,1 cm	14,3 cm

10,4 x 11,1 cm

COMPARTMENT DIMENSIONS



8 COMPARTMENT

	MAXIMUM HEIGHT	6,6 cm	10,7 cm
CODE		8HC258	8HC414
CASE PACK		6	5
EXT. RACK HEIGHT		10,1 cm	14,3 cm

10,4 x 8,73 cm

COMPARTMENT DIMENSIONS



10 COMPARTMENT

	MAXIMUM HEIGHT	6,6 cm	10,7 cm
CODE		10HC258	10HC414
CASE PACK		6	5
EXT. RACK HEIGHT		10,1 cm	14,3 cm

Glass and Cup Keepers

Color: Beige (133).

- Raised ribs for easy draining and drying.
- Holds 20 glasses or 12 cups per layer.



Max. Glass Inside Rim Diameter: GK2000: 6,6 cm

Max. Cup Inside Rim Diameter: KK1200: 7,4 cm

CODE	SIZE	CASE PACK
Glass Keepers		
GK2000 (Regal)	35,6 x 45,7 cm	12
Cup Keepers		
KK1200 (Regal)	35,4 x 45,4	12

Base Cup Rack Color: Soft Grey (151). Extender Color: Soft Grey (151). Personalization available. See Camrack personalization and color coding page. Contact Customer Service for all special orders.

STORE AND TRANSPORT GLASSES & DISHES

Camrack® Cover & Camdolly®

- Use to cover and protect full size Camrack dishracks filled with clean dishware.
- When used with a Camdolly, creates a portable sanitary storage system that protects contents between uses.
- Eliminates the use of messy, wasteful plastic wrap or vinyl covers.



FULL RACK COVER

CODE	DRC2020
EXTERIOR DIMENSIONS	50 x 50 x 2,4 cm

Case Pack: 1 Color: Grey (180).

STOCK PRODUCTS & COLORS AVAILABLE IN OUR EUROPEAN WAREHOUSE

DRC2020: (180)
CDR2020, CDR2020H: (151)



	CAMDOLLY	CAMDOLLY WITH HANDLE
CODE	CDR2020	CDR2020H
INTERIOR DIMENSIONS	53 x 53 cm	53 x 53 cm
EXTERIOR DIMENSIONS	54,5 x 54,5 x 20,5 cm	54,5 x 59,5 x 94 cm
LOAD CAPACITY	159 kg	159 kg

Case Pack: 1 Color: Soft Grey (151). Casters: 10 cm casters, 4 swivel, no brakes.

Camrack IceExpress Glass Filler

- Dramatically reduces banquet set-up time.
- Fills 25 glasses with ice all at once.

- Reduces breakage and risk of contamination.
- Ice falls directly into glasses with no spills or drips.

CODE	EXTERIOR DIM. W x D x H
25SWGf	50,8 x 50,8 x 3,18 cm

Case Pack: 1 Color: Black (110).



SELECTING THE RIGHT CAMRACK

Selecting the Right Camrack

Cambro offers multiple ways to help you quickly find the right Camrack:

1. www.cambro.com/mycamracks

To quickly find the correct Camrack, please visit www.cambro.com/mycamracks. Select the item you are sizing, enter the measurements and quantity of the item, and the right Camrack will appear on the page.

2. Cambro Catalog

Flip to the back of this section for a convenient stemware and glass sizing reference guide.

3. Cambro Sales Representatives

Contact your local Cambro representative and he or she will walk through your current ware

handling system with you and specify Camracks, dollies and covers that will fit your glasses and dishware. To find your local representative refer to the back section of this catalog, visit www.cambro.com and click on "Find a Sales Rep" on the lower left of your screen or call the Cambro Customer Service line: 49-7022-90-100-0.

4. Send a Sample to Cambro

C.E.L. Customer Service.
Kelterstrasse 51
72669 Unterensingen, Germany.

Please be sure to include complete contact information and specify if you need full-size or half-size Camracks.

Choose the correct Camrack:

1. Measure the **maximum diameter** of the glass (stemware or tumbler) to determine the number of compartments.
2. Measure the **maximum height** of the glass (stemware or tumbler) to the top edge of the rim to determine the compartment height.

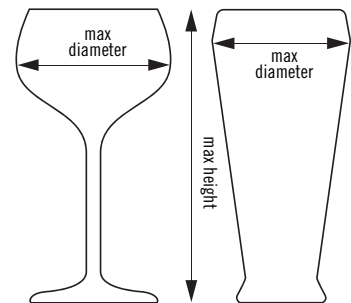

Download the Cambro App:

Find the right Camrack for your Glassware by entering the height and maximum diameter of your glass.



CAMRACK® BASE RACKS

- For pots, pans, bowls and large prep, service and display items.
- Half racks work well for storing items at a wait station.

STOCK PRODUCTS & COLORS AVAILABLE IN OUR EUROPEAN WAREHOUSE

BR258, BR414, BR578, BR712: (110), (119), (151), (163), (184), (167), (168), (186), (414), (416)
CRPHDG2878: (000)



BR578

FULL SIZE BASE RACKS

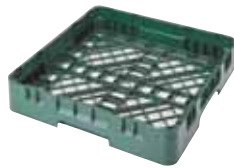

	FULL BASE RACK	WITH 1 EXTENDER	WITH 2 EXTENDERS	WITH 3 EXTENDERS
CODE	BR258	BR414	BR578	BR712
INSIDE RACK HEIGHT	8,3 cm	12,4 cm	16,5 cm	20,6 cm
OUTSIDE RACK HEIGHT	10,1 cm	14,3 cm	18,4 cm	22,5 cm
CASE PACK	6	5	4	3

HALF SIZE BASE RACKS



	HALF BASE RACK	WITH 1 EXTENDER	WITH 2 EXTENDERS	WITH 3 EXTENDERS
CODE	HBR258	HBR414	HBR578	HBR712
INSIDE RACK HEIGHT	8,3 cm	12,4 cm	16,5 cm	20,6 cm
OUTSIDE RACK HEIGHT	10,1 cm	14,3 cm	18,4 cm	22,5 cm
CASE PACK	6	5	4	3

Hold Down Grid

Keeps lightweight smallwares in place during wash cycle. Use on full size Camrack base rack.



CRPHDG2878

FULL SIZE HOLD DOWN GRID

CODE	CRPHDG2878
Case Pack: 6	Color: Gray (000).

Base Rack Colors:

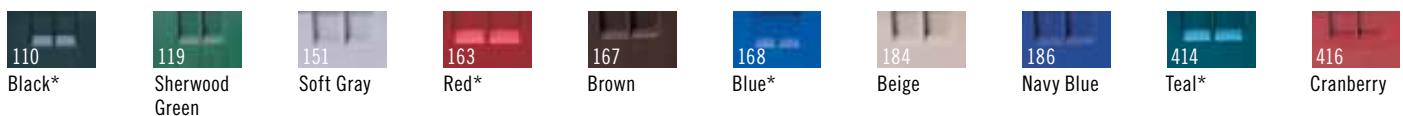

*Full size only. Extender Color: Soft Grey (151). Personalization available. See Camrack personalization and color coding page. For a more accurate color representation, call your sales rep for actual color chips. Contact Customer Service for all special orders.

CAMRACK® FULL SIZE PEG RACKS & TRAY RACK

Standard 9 x 9 Peg Rack

- Designed to wash varying sized plates, bowls, trays and plate covers.
- Standard peg racks hold:
 - Eighteen 25,4 cm plates
 - Twelve 30,5 cm plates
 - Twenty-seven 19 cm plates
 - or
 - Nine 36 x 46 cm trays

5 x 9 Peg Rack

- Holds standard plates in one direction or deep plates, bowls and plate covers in the other direction.
- 5 spacing configuration holds up to ten 25,4 cm bowls, deep plates, platters or plate covers.

- 9 spacing configuration holds up to:
 - Eighteen 25,4 cm plates
 - Twelve 30,5 cm plates
 - Twenty-seven 19 cm plates
 - or
 - Nine 36 x 46 cm trays

Open End Tray Rack

- Holds cafeteria trays or full-size sheet pans.
- Open-ended on one side for easy placement and removal of trays of all lengths.
- Holds up to nine trays upright.

STOCK PRODUCTS & COLORS AVAILABLE IN OUR EUROPEAN WAREHOUSE

PR59314, PR59500, PR314, OETR314: (151)



	9 X 9 PEG RACK	9 X 9 PEG RACK WITH 1 EXTENDER	5 X 9 PEG RACK	5 X 9 PEG RACK WITH 1 EXTENDER	OPEN END TRAY RACK
CODE	PR314	PR500	PR59314	PR59500	OETR314*
INSIDE RACK HEIGHT	8,3 cm	12,4 cm	8,3 cm	12,4 cm	8,3 cm
OUTSIDE RACK HEIGHT	10,1 cm	14,3 cm	10,1 cm	14,3 cm	10,1 cm
CASE PACK	6	5	6	5	6

Color: Soft Gray (151). **Extender Color:** Soft Gray (151). **InStock Color:** Soft Gray (151). Personalization available. See Camrack personalization and color coding page. Contact Customer Service for all special orders. *Extenders may be added to all Peg Racks except the OETR314.

CAMRACK FULL & HALF SIZE FLATWARE RACKS & CYLINDER

- 8 Compartment Basket fits into a Full or Half Size Base Rack. Wire handles slide down for easy storage.

- Flatware Cylinder fits into 9-Compartment Full Size Camrack and the Cambro Tray and Dish Cart, model TDCR12.

STOCK PRODUCTS & COLORS AVAILABLE IN OUR EUROPEAN WAREHOUSE

FR258, 8FB434, 8FBNH434: (151)

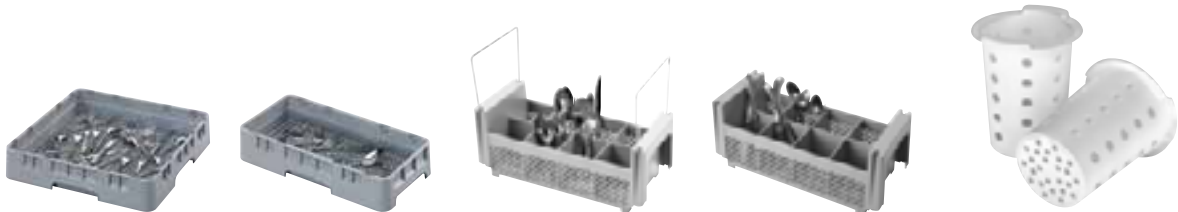

	FULL FLATWARE RACK	HALF FLATWARE RACK	8 COMPARTMENT HALF FLATWARE BASKET	8 COMPARTMENT HALF FLATWARE BASKET	FLATWARE CYLINDER
CODE	FR258	HFR258	8FB434* With Handles	8FBNH434* No Handles	FWC56
INSIDE RACK HEIGHT	6,7 cm	6,7 cm	12 cm	12 cm	Wide 11,4 cm
OUTSIDE RACK HEIGHT	10,1 cm	10,1 cm	18,4 cm	18,4 cm	High 14 cm
CASE PACK	6	6	6	6	12

Color: Soft Gray (151). **Extender Color:** Soft Gray (151). **InStock Color:** Soft Gray (151). **Flatware Cylinder Color:** White (148). Personalization available. See Camrack personalization and color coding page. Contact Customer Service for all special orders. *Extenders cannot be added.

THE CAMRACK® COMPONENT SYSTEM

The Camrack System offers several choices for ordering the right Camracks now and as your needs change. Please consult with your sales representative or Cambro Customer Service for all special ordering and assembly directions.

Choose Between:

1. A complete selection of pre-assembled, ready to use Camracks listed in our catalog; or
2. Custom built special order Camracks for specific needs; or
3. Individual Camrack components for distributors to stock and build racks as needed.

Base Rack Colors:

Sherwood Green (119),
Soft Grey (151), Brown (167), Beige (184),
Navy Blue (186), Cranberry (416),
Black (110)*, Red (163)*, Blue (168)*,
Teal (414)*.

Base Cup Rack Color: Soft Grey (151).

Extender Color: Soft Grey (151).

Personalization available.

Full Base Racks are covered by
U.S. Patent D 412,607.

Half Base Racks are covered by
U.S. Patent D 404,176.

*Full size only.

STOCK PRODUCTS & COLORS AVAILABLE IN OUR EUROPEAN WAREHOUSE

9E1, 9E2, 16E1, 16E2, 16E4, 16E5, 20E2, 20GE1, 20GE2, 20GE4, 20GE5, 25E1, 25E2, 25E4, 25E5,
30GE1, 30GE2, 36E1, 36E2, 36E4, 36E5, 49E1, 49E2, 16C258, 20C258: (151)
BR258: (110), (119), (151), (163), (184), (167), (168), (186), (414), (416)
E3: (151)

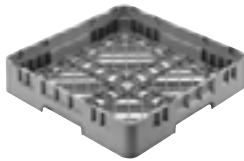

BR = Full Size Base Rack



HBR = Half Size Base Rack

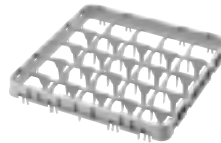

E1 = Full Size Full Drop
Compartment Extender

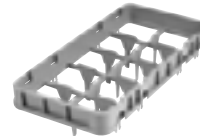

HE1 = Half Size Full Drop
Compartment Extender



E2 = Full Size Half Drop
Compartment Extender



HE2 = Half Size Half Drop
Compartment Extender

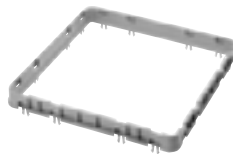

E3 = Full Size Open
Extender

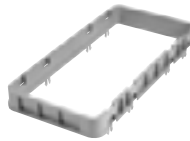

HE3 = Half Size Open
Extender

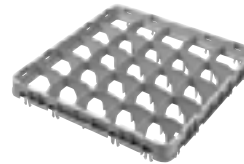

E4 = Full Size Full Drop
Stemware Extender

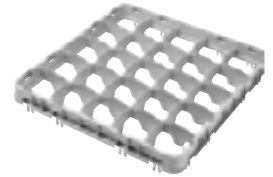

E5 = Full Size Half Drop
Stemware Extender

Only E3 extenders may be added to E4's and E5's.

Camracks Components

CODE	DESCRIPTION	EXTERIOR DIMENSIONS	COMPARTMENT	INSIDE RACK HEIGHT	CASE PACK
Full Size Base Racks					
BR258*	Full Base Rack	500 x 500 x 101 mm	457 x 457 mm	67 mm	6
Half Size Base Racks					
HBR258	Half Base Rack	500 x 250 x 101	464 x 213	67	6
Full Size Base Cup Racks					
16C258	16-Compartment Full Cup Rack	500 x 500 x 101	111 x 111	67	6
20C258	20-Compartment Full Cup Rack	500 x 500 x 101	111 x 89	67	6
Half Size Base Cup Racks					
8HC258	8-Compartment Half Cup Rack	500 x 250 x 101	105 x 113	67	6
10HC258	10-Compartment Half Cup Rack	500 x 250 x 101	105 x 89	67	6
Full Size Full Drop Extenders – E1 and GE1					
9E1	9-Compartment Full Drop Extender	499 x 499 x 51	150 x 150	41	12
16E1	16-Compartment Full Drop Extender	499 x 499 x 51	111 x 111	41	12
20GE1	20-Compartment Full Drop Extender	499 x 499 x 51	98 x 98	41	12
25E1	25-Compartment Full Drop Extender	499 x 499 x 51	89 x 89	41	12
30GE1	30-Compartment Full Drop Extender	499 x 499 x 51	79 x 79	41	12
36E1	36-Compartment Full Drop Extender	499 x 499 x 51	73 x 73	41	12
49E1	49-Compartment Full Drop Extender	499 x 499 x 51	62 x 62	41	12

THE CAMRACK® COMPONENT SYSTEM

CODE	DESCRIPTION	EXTERIOR DIMENSIONS	COMPARTMENT	INSIDE RACK HEIGHT	CASE PACK
Full Size Half Drop Extenders – E2 and GE2					
9E2	9-Compartment Half Drop Extender	499 x 499 x 51 mm	150 x 150 mm	41 mm	12
16E2	16-Compartment Half Drop Extender	499 x 499 x 51	111 x 111	41	12
20E2	20-Compartment Half Drop Extender (for cups only)	499 x 499 x 51	111 x 89	41	12
20GE2	20-Compartment Half Drop Extender	499 x 499 x 51	98 x 98	41	12
25E2	25-Compartment Half Drop Extender	499 x 499 x 51	89 x 89	41	12
30GE2	30-Compartment Half Drop Extender	499 x 499 x 51	79 x 79	41	12
36E2	36-Compartment Half Drop Extender	499 x 499 x 51	73 x 73	41	12
49E2	49-Compartment Half Drop Extender	499 x 499 x 51	62 x 62	41	12
Full Size Open Extender – E3					
E3	Open Extender	499 x 499 x 51	457 x 457	41	12
Full Size Full Drop Extenders – E4					
16E4	16-Compartment Full Drop Extender	499 x 499 x 51	111 x 111	41	12
20GE4	20-Compartment Full Drop Extender	499 x 499 x 51	98 x 98	41	12
25E4	25-Compartment Full Drop Extender	499 x 499 x 51	89 x 89	41	12
36E4	36-Compartment Full Drop Extender	499 x 499 x 51	73 x 73	41	12
Full Size Half Drop Extenders – E5					
16E5	16-Compartment Half Drop Extender	499 x 499 x 51	111 x 111	41	12
20GE5	20-Compartment Half Drop Extender	499 x 499 x 51	98 x 98	41	12
25E5	25-Compartment Half Drop Extender	499 x 499 x 51	89 x 89	41	12
36E5	36-Compartment Half Drop Extender	499 x 499 x 51	73 x 73	41	12
Half Size Full Drop Extenders – HE1					
8HE1	8-Compartment Full Drop Extender	502 x 252 x 51	105 x 113	41	12
10HE1	10-Compartment Full Drop Extender	502 x 252 x 51	105 x 89	41	12
17HE1	17-Compartment Full Drop Extender	502 x 252 x 51	74 diameter	41	12
Half Size Half Drop Extenders – HE2					
8HE2	8-Compartment Half Drop Extender	502 x 252 x 51	105 x 113	41	12
10HE2	10-Compartment Half Drop Extender	502 x 252 x 51	105 x 89	41	12
17HE2	17-Compartment Half Drop Extender	502 x 252 x 51	74 diameter	41	12
Half Size Open Extender – HE3					
HE3	Open Extender	502 x 252 x 51	464 x 213	41	12

Base Rack Colors: Sherwood Green (119), Soft Gray (151), Brown (167), Beige (184), Navy Blue (186), Cranberry (416), Black (110)*, Red (163)*, Blue (168)*, Teal (414)*.

Base Cup Rack Color: Soft Gray (151). **Extender Color:** Soft Gray (151). *Color available in full size only. All extenders are available in Soft Gray (151). All pre-assembled racks ship with Soft Gray (151) extenders. **PlateSafe Grid Color:** Gray (000).



STOCK PRODUCTS & COLORS AVAILABLE IN OUR EUROPEAN WAREHOUSE

9E1, 9E2, 16E1, 16E2, 16E4, 16E5, 20E2, 20GE1, 20GE2, 20GE4, 20GE5, 25E1, 25E2, 25E4, 25E5, 30GE1, 30GE2, 36E1, 36E2, 36E4, 36E5, 49E1, 49E2, 16C258, 20C258: (151)
 BR258: (110), (119), (151), (163), (184), (167), (168), (186), (414), (416)
 E3: (151)

LET'S GET PERSONAL – PERSONALIZED CAMRACKS®

Personalize Camracks to identify contents at a glance for accurate inventory control and selection.

Hot stamp a custom logo, information or standard content symbols, and/or descriptions on two opposite, diagonal sides of any rack.

Or request the addition of pre-printed clips. Up to 4 Camrack clips can be added only at time of assembly and require the addition of at least one extender.



IMPRINT COLOR-WHITE

HOW TO ORDER A SAMPLE

1. Contact your local Cambro rep to complete and submit a sample request form to Cambro.
2. Select rack size, code and color. Imprint color - white only.
3. Choose process A) Hot Stamp or B) Camrack Clips
4. Indicate location of hot stamp and or clip on rack. Maximum hot stamp imprint size is W 102 x H 31,7 mm. Maximum hot stamp imprinting thickness per solid letter or logo should be no more than 102 mm wide.
5. If selecting process A with a custom hot stamp, provide ready to use artwork, digital format only. Sample request form must be submitted to Cambro PRIOR to artwork being sent. If artwork is incomplete, graphic support services are available for **per hour.

6. Submit Artwork

E-mail artwork to your Cambro Rep or direct to Cambro at letsgetpersonal@cambro.com. Title e-mail subject with logo name and provide contact info. **File dimensions:** 100% reproduction size, 300dpi resolution.

File type: Adobe® Illustrator®, Photoshop®. **File format:** jpeg, tiff, and eps. Or mail digital artwork to: CEL - Attn: C.E.L. Customer Service. Kelterstrasse 51 72669 Unterensingen, Germany.

7. Questions regarding artwork?

Tel: (49)7022-90-100-0; Ireland Tel: 1800 509 046; for UK Tel: 0800 587 0057 or Fax: (49)7022-90-100-19.

8. Sample Approval

A signed sample approval form must be faxed to Cambro customer service prior to processing any purchase orders. This form is included with each sample.

PERSONALIZATION CHARGES

One Time Plate Charge	**for custom hot stamp only
Set-Up Charge	**
Sample Charge	**
Imprint Charge	**per side, 2 sides max.

FOR CLIPS

Drinkware or PlateSafe®, pre-printed **each

**Contact your Cambro representative for pricing.

STANDARD HOT STAMP SYMBOLS AND/OR DESCRIPTIONS

Step 1. Choose a symbol and corresponding letter that best fits your glassware.

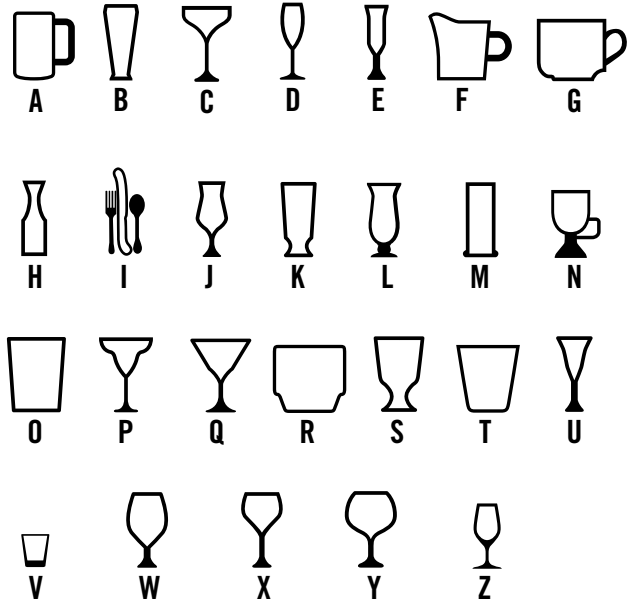

Step 2. Choose the verbiage and corresponding number that best describes your glassware. **Available in English Only.**

- | | | |
|--------------------|--------------------------|---------------------------|
| 1. Beer | 13. Flatware | 25. Rocks (Tumbler Style) |
| 2. Beer Mug | 14. Goblet | 26. Sherry |
| 3. Pilsner | 15. Grande | 27. Shot Glass |
| 4. Brandy | 16. Hi-Ball | 28. Sorbet |
| 5. Champagne | 17. Hurricane | 29. Water (Footed Style) |
| 6. Champagne Flute | 18. Iced Tea | 30. Water (Tumbler Style) |
| 7. Coffee Mug | 19. Irish Coffee | 31. White Wine |
| 8. Collins | 20. Juice | 32. Wine |
| 9. Cordial | 21. Margarita | 33. Red Wine |
| 10. Creamer | 22. Martini | 34. Port |
| 11. Cup | 23. Old Fashion | |
| 12. Decanter | 24. Rocks (Footed Style) | |

PERSONALIZATION OPTIONS HOT STAMPING



CUSTOM LOGO AND/OR TEXT



STANDARD SYMBOL AND DESCRIPTION



STANDARD SYMBOL ONLY





































STANDARD DESCRIPTION ONLY

CAMRACK® EXTENDER ID CLIP

- The industry's only 4-in-1 glassware management system makes inventory management quick and easy.
- Made of ABS, these clips are virtually unbreakable, and designed to withstand the high heat of commercial dishwashers.
- An economical and sustainable solution to discarding existing racks or labeling with markers, tape or wall placards.



PRE-PRINTED CLIPS (Available in 6-packs) Contact your Cambro representative for pricing.

		CODE			CODE			CODE
	Beer	CECBE6000		Goblet	CECGO6000		Rocks (Footed Style)	CECRF6000
	Beer Mug	CECBM6000		Grande	CECGR6000		Rocks (Tumbler Style)	CECRT6000
	Brandy	CECBR6000		Hi-Ball	CECHB6000		Sherry	CECSH6000
	Champagne	CECCH6000		Hurricane	CECHU6000		Shot Glass	CECSG6000
	Champagne Flute	CECCF6000		Iced Tea	CECIT6000		Sorbet	CECSB6000
	Coffee Mug	CECCM6000		Irish Coffee	CECIC6000		Water (Footed Style)	CECWF6000
	Collins	CECCL6000		Juice	CECJU6000		Water (Tumbler Style)	CECWT6000
	Cordial	CECCO6000		Margarita	CECMG6000		White Wine	CECWW6000
	Creamer	CECCR6000		Martini	CECMT6000		Wine	CECWI6000
	Cup	CECCP6000		Old Fashion	CECOF6000		Port	CECPO6000
	Decanter	CECDC6000		Pilsner	CECPI6000			CECBL6000 Blank Clip
	Flatware	CECFL6000		Red Wine	CECRW6000			

STOCK PRODUCTS & COLORS AVAILABLE IN OUR EUROPEAN WAREHOUSE

CECGO6000, CECJU6000, CECMG6000, CECMT6000, CECOF6000, CECRW6000, CECWW6000, CECBE6000, CECCF6000, CECBL6000

(Available in English Only)

- Use to transport anything from stacks of sheet pans to catering equipment.
- Reduce employee lifting and carrying, reducing possible injury.
- Made of extremely durable plastic that will not dent, crack, rust or corrode.
- Heavy-duty casters maneuver easily over all types of terrain.
- For heavy transport needs, select models with handles and rear Big Wheels.

Colors: Coffee Beige (157), Dark Brown (131), Black (110), Slate Blue (401).
CDR2020, CDR2020H Color: Soft Gray (151).

Caster Type

- A:** 12,7 cm Casters: 2 fixed, 2 swivel, 1 with brake.
B: 7,6 cm Casters: 4 swivel, no brakes.
C: 25,4 cm Rear Big Wheels, 2 front 12,7 cm swivel casters, 1 with brake.
D: 8,9 cm Casters: 4 swivel, no brakes.

Available Parcel Carrier Delivery:

CDR2020, CDR2020H, CD2020, CD1420, CD2028, CD1313, CD1327, CD100, CD160, CD200, CD300, CD400, CD1826PDB, 203OUT & 400STP.

Camdollies Case Pack: 1

*CDR2020H Not NSF Listed.

STOCK PRODUCTS & COLORS AVAILABLE IN OUR EUROPEAN WAREHOUSE

CDR2020, CDR2020H: (151)

For Dish Racks

EXTERNAL DIM. W x D x H 54,5 x 53 x 18,7 cm
INTERIOR DIM. W x D 53 x 53 cm

159 kg CAPACITY	D CASTER TYPE
---------------------------	-------------------------



CDR2020

EXTERNAL DIM. W x D x H 53 x 64,1 x 92,7 cm
INTERIOR DIM. W x D 53 x 53 cm

159 kg CAPACITY	D CASTER TYPE
---------------------------	-------------------------



CDR2020H*
With powder coated handle.

For 46 x 66 cm Trays and Sheet Pans

EXTERNAL DIM. W x D x H 50,8 x 80 x 97,2 cm
INTERIOR DIM. W x D 46 x 66 cm

Holds: UPC101

136 kg CAPACITY	A CASTER TYPE
---------------------------	-------------------------



CD1826H

EXTERNAL DIM. W x D x H 57 x 57 x 21 cm
INTERIOR DIM. W x D 51,1 x 51,1 cm

Also Holds: 500LCD, 350LCD, 250LCD, 1000LCD, UC1000

136 kg CAPACITY	B CASTER TYPE
---------------------------	-------------------------



CD2020

EXTERNAL DIM. W x D x H 59,7 x 82,6 x 93 cm
INTERIOR DIM. W x D 47 x 66 cm

Holds: UPC101

136 kg CAPACITY	C CASTER TYPE
---------------------------	-------------------------



CD1826HB

EXTERNAL DIM. W x D x H 56,5 x 65,7 x 93,7 cm
INTERIOR DIM. W x D 51,5 x 51,5 cm

Also Holds: 250LCD, 350LCD, 500LCD, 1000LCD

159 kg CAPACITY	B CASTER TYPE
---------------------------	-------------------------



CD2020H

For Pizza Dough Boxes

Also See Pizza Dough Boxes page 167

EXTERNAL DIM. W x D x H 50,5 x 71 x 26 cm
INTERIOR DIM. W x D 44,5 x 64,5 cm

Holds: DB18263CW, DB18266CW, DB18263P

136 kg CAPACITY	A CASTER TYPE
---------------------------	-------------------------



CD1826PDB
Optional strap available.

EXTERNAL DIM. W x D x H 66,7 x 67,3 x 93 cm
INTERIOR DIM. W x D 52 x 52,5 cm

Also Holds: 250LCD, 350LCD, 500LCD

159 kg CAPACITY	C CASTER TYPE
---------------------------	-------------------------



CD2020HB

CAMDOLLIES®

For Camcarriers® and Camtainers®

EXTERNAL DIM. W x D x H 50 x 73 x 27 cm

INTERIOR DIM. W x D 44 x 66,5 cm

Holds: 100MPC, UPC100, UC250, UC500, 250LCD, 350LCD, 500LCD

136 kg CAPACITY	A CASTER TYPE
---------------------------	-------------------------



CD100



EXTERNAL DIM. W x D x H 50 x 84 x 92 cm

INTERIOR DIM. W x D 45 x 67,5 cm

Holds: 100MPC, UC250, UC500, 250LCD, 350LCD, 500LCD

159 kg CAPACITY	A CASTER TYPE
---------------------------	-------------------------



CD100H



EXTERNAL DIM. W x D x H 60 x 83,5 x 93 cm

INTERIOR DIM. W x D 44,5 x 68 cm

Holds: 100MPC, UPC100, UC250, UC500, 250LCD, 350LCD, 500LCD

159 kg CAPACITY	C CASTER TYPE
---------------------------	-------------------------



CD100HB



EXTERNAL DIM. W x D x H 42 x 62 x 26,5 cm

INTERIOR DIM. W x D 36 x 56 cm

Holds: UPC140, UPC160, UPC180, UPCS140, UPCS160, UPCS180, UPCS160

136 kg CAPACITY	A CASTER TYPE
---------------------------	-------------------------



CD160



EXTERNAL DIM. W x D x H 49 x 65 x 26,5 cm

INTERIOR DIM. W x D 43 x 59 cm

Holds: 300MPC, 1318MTC, UC1000, 1000LCD, UPC300, 1318CC

159 kg CAPACITY	A CASTER TYPE
---------------------------	-------------------------



CD300



EXTERNAL DIM. W x D x H 61 x 89,5 x 93 cm

INTERIOR DIM. W x D 56 x 72,5 cm

Holds: 1826MTC

159 kg CAPACITY	A CASTER TYPE
---------------------------	-------------------------



CD1826MTC



EXTERNAL DIM. W x D x H 70 x 88,5 x 93,5 cm

INTERIOR DIM. W x D 55,5 x 72,5 cm

Holds: 1826MTC

159 kg CAPACITY	C CASTER TYPE
---------------------------	-------------------------



CD1826MTCHB



EXTERNAL DIM. W x D x H 48,5 x 76,5 x 92 cm

INTERIOR DIM. W x D 43 x 59 cm

Holds: 300MPC, 1318MTC, UC1000, 1000LCD, UPC300, 1318CC

159 kg CAPACITY	A CASTER TYPE
---------------------------	-------------------------



CD300H



EXTERNAL DIM. W x D x H 60 x 76 x 92 cm

INTERIOR DIM. W x D 44 x 60 cm

Holds: 300MPC, 1318MTC, UC1000, 1000LCD, UPC300, 1318CC

159 kg CAPACITY	C CASTER TYPE
---------------------------	-------------------------



CD300HB



EXTERNAL DIM. W x D x H 53 x 70 x 23 cm

INTERIOR DIM. W x D 46 x 63,5 cm

Holds: UPC400, UPCS400, UPCH400

136 kg CAPACITY	A CASTER TYPE
---------------------------	-------------------------



CD400

Shown with
Optional Strap.



STOCK PRODUCTS & COLORS AVAILABLE IN OUR EUROPEAN WAREHOUSE

CD300, CD400: (401)

CAMDOLLIES® for Milk Crates and #10 Can Cases

EXTERNAL DIM. W x D x H 41,28 x 55,25 x 21,11 cm
INTERIOR DIM. W x D 35,24 x 49,05 cm
Holds: 35,6 x 48,3 cm Milk Crates and #10 Can Cases

159 kg CAPACITY	B CASTER TYPE
---------------------------	-------------------------



CD1420



- Use for transporting loads of up to 272 kg.
- Large platforms for convenient loading and built-in handles for easy maneuvering.
- All models feature 12,7 cm heavy-duty casters bolted into molded-in metal backing plates.

Colors: Coffee Beige (157), Dark Brown (131), Black (110), Slate Blue (401).

Casters: 12,7 cm, 2 fixed, 2 swivel, 1 with brake.

Utility Trucks Case Pack: 1

EXTERNAL DIM. W x D x H 56,6 x 77 x 21 cm
INTERIOR DIM. W x D 49,5 x 71 cm
Holds: 35,6 x 48,3 cm Milk Crates, #10 Can Cases and UPC101, 300MPC, UPC400, 100MPC, UPC100, UPC300

159 kg CAPACITY	B CASTER TYPE
---------------------------	-------------------------



CD2028



EXTERNAL DIM. W x D x H 50 x 81,5 x 98 cm
LOAD PLATFORM 50 x 75 cm

272 kg CAPACITY



2030UT
With chrome handle.
UTHSTP
508 cm long strap.

EXTERNAL DIM. W x D x H 41 x 41 x 21 cm
INTERIOR DIM. W x D 35 x 35 cm
Holds: 30 x 30 cm Milk Crates

114 kg CAPACITY	B CASTER TYPE
---------------------------	-------------------------



CD1313



EXTERNAL DIM. W x D x H 63,2 x 106 x 93,3 cm
LOAD PLATFORM 60 x 90,5 cm

272 kg CAPACITY



2436UTH
UTHSTP
508 cm Long Strap.

EXTERNAL DIM. W x D x H 40,6 x 73,7 x 21 cm
INTERIOR DIM. W x D 34,6 x 67,6 cm
Holds: 30 x 30 cm Milk Crates and #10 Can Cases

136 kg CAPACITY	B CASTER TYPE
---------------------------	-------------------------



CD1327



EXTERNAL DIM. W x D x H 63,2 x 106 x 93,3 cm
LOAD PLATFORM 60 x 90,5 cm

272 kg CAPACITY



2436UTHS
Includes two straps.

Camdolly® Strap for CD400 and CD1826PDB Camdollies

CODE	DESCRIPTION	EXTERNAL DIM.
400STP	Strap	500 cm long

Case Pack: 1



TRAY & DISH CART / TRAY & SILVERWARE CART

Tray & Dish Cart

- Open storage compartment holds a wide variety of plates and trays.
- Use with or without detachable cutlery station.
- Made of easy-to-clean polyethylene that won't rust, peel or corrode.
- Rounded, molded-in corners protect furniture and walls.
- Molded-in handles and heavy-duty 15,2 cm swivel casters ease maneuvering.

Colors: Black (110), Slate Blue (401), Coffee Beige (157), Dark Brown (131), Granite Grey (191), Granite Green (192).

15,2 cm Casters: All swivel, 2 with brake.

Vinyl cover is not NSF listed.



Flatware cylinders and vinyl cover included with TDCR12.



Vinyl cover included for sanitary storage. TDCR12 only.



TDCR12

CODE	DESCRIPTION	EXTERIOR DIM. L x W x H
TDCR12	Cart & rack combination	97 x 58 x 105 cm
TDC2029*	Cart only	97 x 56,5 x 87
CR12	Cutlery rack only	84 x 58 x 23
FWC56	Flatware cylinder	W 11,4 x H 14

Case Pack: 1 **FWC56 Case Pack:** 12
 *TDC2029 is not available in Black (110).

Tray & Silverware Cart

- Use to neatly organize trays and accessories for self-service.
- Includes eight clear Camwear® food pans to hold flatware, napkins and non-perishable condiments.
- Protective vinyl cover included.

Colors: Black (110), Slate Blue (401), Coffee Beige (157), Dark Brown (131), Granite Grey (191), Granite Green (192).

15,2 cm Casters: All swivel, 2 with brake.

Vinyl cover is not NSF listed.



STOCK PRODUCTS & COLORS AVAILABLE IN OUR EUROPEAN WAREHOUSE
TC1418: (401)

CODE	DESCRIPTION	CASE PACK
TC1418	Cart w/pans & vinyl cover	1

CODE	EXTERIOR DIM. L x W x H	WEIGHT CAPACITY	MAXIMUM TRAY SIZE	TRAY CAPACITY
TC1418	82 x 54 x 116 cm	227 kg	36 x 46 cm	180-200 in two stacks

Camwear Pans for self-serve top:

PAN QUANTITY, SIZE	CAPACITY
4 each, 1/3 size x 10 cm deep	Holds 100 knives, 100 spoons, 80 forks
4 each, 1/6 size x 10 cm deep	Holds variety of condiments



TC1418



Use the vinyl cover for sanitary storage (included).



S-SERIES ADJUSTABLE DISH CADDY



- Store one size dish or a combination of different sizes in a single caddy.
- Features easy-to-adjust column towers.

ADCS Colors: Black (110), Slate Blue (401), Speckled Grey (480), Dark Brown (131).

Casters: Two 12,7 cm, swivel with brakes and two 25,4 cm easy wheels.

Vinyl cover included. Not NSF listed.

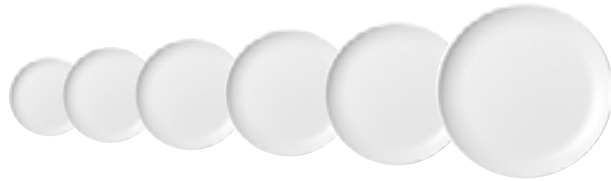

Holds plates and bowls from 11,7 to 33 cm

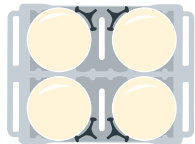

Plate sizes: ø 23,5 cm to 33 cm
4 Columns (60 each)
Total Capacity: 240

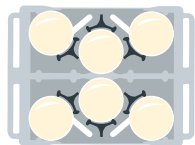

Plate sizes: ø 18,42 cm to 23,5 cm
6 Columns (60 each)
Total Capacity: 360

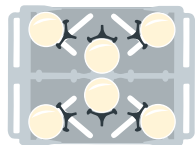
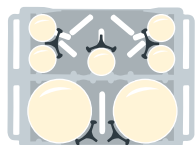
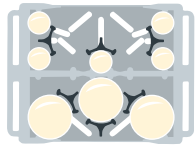

Plate sizes: ø 14,6 cm to 18,42 cm
6 Columns (45 each)
Total Capacity: 270



2 Columns: ø 23,5 cm to 33 cm (60 each)
5 Columns: ø 12,6 cm (45 each)
Total Capacity: 345



3 Columns: ø 18,42 cm to 23,5 cm (60 each)
5 Columns: ø 11,75 cm (45 each)
Total Capacity: 405

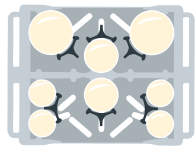

2 Columns: ø 18,42 cm to 23,5 cm (60 each)
2 Columns: ø 14,6 cm to 18,42 cm (45 each)
4 Columns: ø 12,6 cm (45 each)
Total Capacity: 390

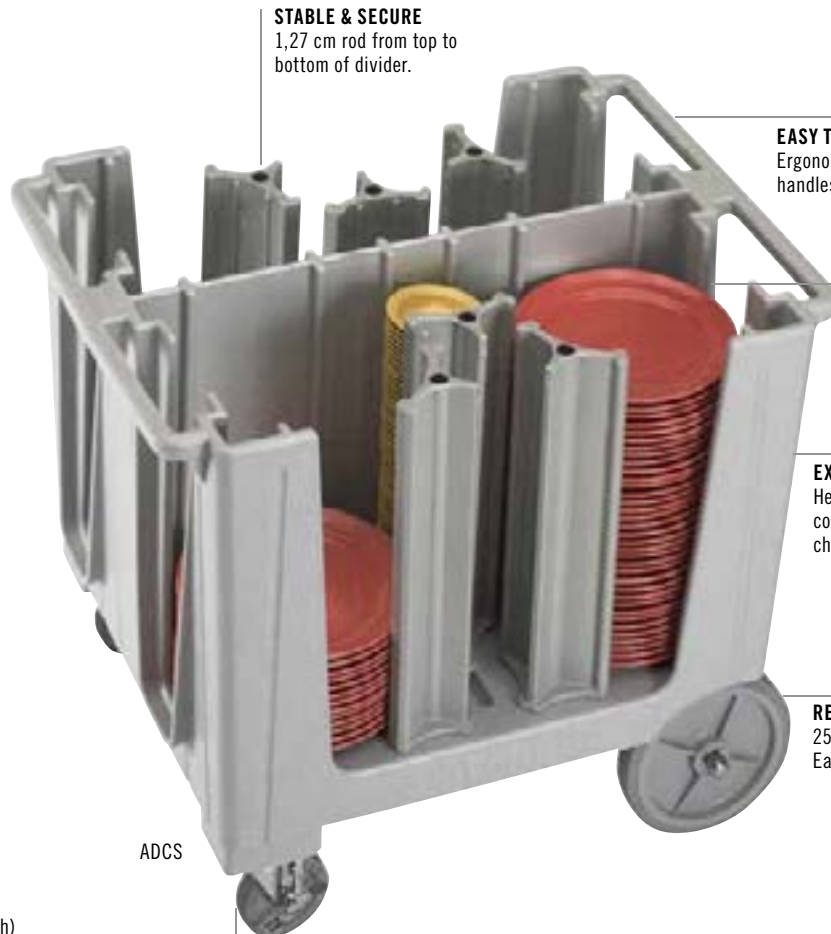

STABLE & SECURE
1,27 cm rod from top to bottom of divider.

EASY TO MANEUVER
Ergonomic molded-in handles on both ends.

HOLDING CAPACITY
49,5 cm storage columns hold 45-60 plates per stack.

EXTREMELY DURABLE
Heavy duty polyethylene construction protects china from chipping. Won't chip, crack or rust.

REAR WHEELS
25,4 cm non-marking Easy Wheels.

ADCS

FRONT CASTERS
12,7 cm swivel with brake.



A 2 cm plated steel rear axle allows for 227 kg load capacity.



Vinyl cover included with every dolly for sanitary storage.

STOCK PRODUCTS & COLORS AVAILABLE IN OUR EUROPEAN WAREHOUSE

ADCS: (110), (401), (480)

CODE	ADCS
NUMBER OF DIVIDERS	6
PLATES PER COLUMN	Approximately 45-60
OVERALL DIMENSIONS W x L x H	73 x 96 x 81 cm
Case Pack: 1	Plate size range from 11,7 to 33 cm.

ADC33 ADJUSTABLE DISH CADDY

- Unlimited versatility with fully adjustable tower dividers.
- Safely store plates, bowls, platters and trays of assorted shapes and sizes.
- Ergonomic, durable and easy to maneuver.

ADC33 Colors: Dark Brown (131), Slate Blue (401).

15 cm Casters: 4 swivel with brake and 1 center rigid.

Sanitary vinyl cover included. Cover not NSF listed.



ADC33 is not available from City of Industry, California U.S.A.



Holds dinnerware from 11 to 33 cm

CODE	ADC33
NUMBER OF DIVIDERS	6
PLATES PER COLUMN	Approximately 45-60
OVERALL DIMENSIONS W x L x H	76,2 x 98,43 x 90,17 cm

Case Pack: 1

Ergonomic handles built flush into either side wall make the ADC33 compact and comfortable to handle.



ADC33

15,24 cm swivel casters with brakes at each corner.

Rigid caster in center of the unit makes maneuvering a breeze, even when fully loaded.

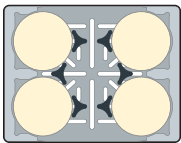

6 Dividers:
4 stacks (11-33 cm) Rounds

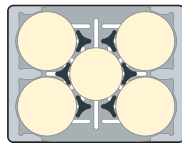

6 Dividers:
4 stacks (11-33 cm) Rounds +
1 stack (17.5-30 cm) Rounds

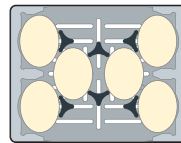

6 Dividers:
6 stacks
(20,3-29,2 x 12,7-21,9 cm) Ovals

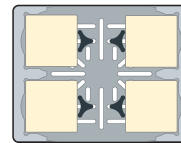

4 Dividers:
4 stacks (25-28,8 cm) Squares

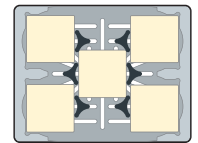

6 Dividers:
5 stacks (24-27,9 cm) Squares

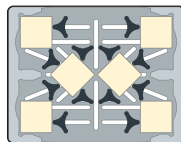

12 Dividers:
6 stacks (15,2-20,3 cm)
Squares or Rounds

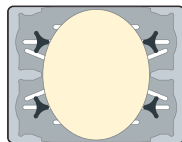

4 Dividers:
1 stack (35-73,6 cm) long x
up to (59,9 cm) wide Oval trays

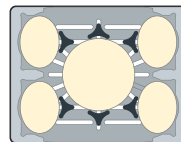

6 Dividers:
4 stacks Ovals
(29,2 x 21,9 cm); 1 stack
40,6 cm Round Tray

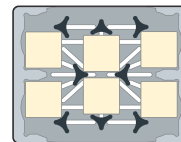

8 Dividers:
6 stacks (20,3 cm)
Medium Squares

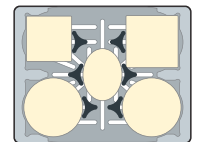

6 Dividers:
2 stacks (33,7 cm) Large Rounds,
1 stack (25,4 cm) Medium Squares,
1 stack (29,2 cm) Large Squares,
1 stack (29,2 x 21,9 cm) Medium
Ovals

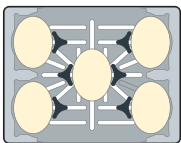

6 Dividers:
5 stacks (29,2 x 21,9 cm) Ovals

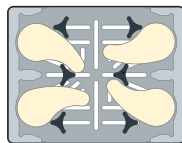

6 Dividers:
4 stacks Custom Plates

**STOCK PRODUCTS & COLORS
AVAILABLE IN OUR EUROPEAN
WAREHOUSE**

ADC33: (131)

VERSA DISH CADDIES™, DISH CADDIES, ADJUSTABLE TRAY & DISH CART

Versa Dish Caddies

- Secure, high-capacity storage to protect both square and round plates.
- Durable, polyethylene exterior will not rust, crack, dent or chip.
- Poker chip style offers greater access for easy plate removal.
- A 2 cm plated steel rear axle allows for 227 kg load capacity.
- Molded-in handles on both ends for easy transporting.
- 12,7 cm front swivel casters with brake and 25,4 cm non-marking rear wheels ease maneuvering.
- No assembly required.

Colors: Black (110), Dark Brown (131), Speckled Grey (480).

Casters: 2, 12,7 cm swivel with brakes and two 25,4 cm Easy Wheels.

Vinyl cover included. Not NSF listed.

DCS950 is covered by U.S. Patent D 603,120S. DCS1125 is covered by U.S. Patent D 625,894.

STOCK PRODUCTS & COLORS AVAILABLE IN OUR EUROPEAN WAREHOUSE

DCS950, DCS1125: (480)



DCS1125 holds 4 columns of 45-60 round plates up to 28,6 cm or square plates up to 24,1 cm.

DCS950 holds 5 columns of 45-60 round plates up to 24,1 cm or 4 to 5 columns of square plates up to 20,5 cm.

Poker Chip Style Dish Caddies

- Use to store and protect valuable dishware.
- Dividers are molded into the body in a standard poker chip design.
- Made of durable polyethylene that protects plates from chipping.
- Open access from two sides for easy loading and unloading.
- Rounded corners inside and out protect dishware, furniture and walls.

Colors: Black (110), Slate Blue (401), Dark Brown (131), Granite Grey (191).

Casters: 2, 12,7 cm swivel with brakes and two 25,4 cm Easy Wheels.

Vinyl cover included. Not NSF listed.



STOCK PRODUCTS & COLORS AVAILABLE IN OUR EUROPEAN WAREHOUSE

DC1225: (191)



DC700



Sanitary plastic cover included and recommended for protecting clean dinnerware & trays.

Replacement covers are available through the Cambro Replacement Parts List at www.cambro.com.

Adjustable Tray & Dish Cart

- Use to store a wide variety of plates and trays.
- Move two adjustable dividers into position easily to secure trays and plates.
- Made of durable polyethylene that cushions plates and trays to prevent chipping.
- Easy to clean and won't dent, rust, chip or break.

Colors: Black (110), Slate Blue (401), Coffee Beige (157), Dark Brown (131), Granite Grey (191), Granite Green (192).

Casters: 15,2 cm all swivel, 2 with brake.

Maximum load capacity: 227 kg.

Vinyl cover included. Not NSF listed.



STOCK PRODUCTS & COLORS AVAILABLE IN OUR EUROPEAN WAREHOUSE

TDC30: (191)



TDC30



Vinyl cover included with every dolly for sanitary storage.

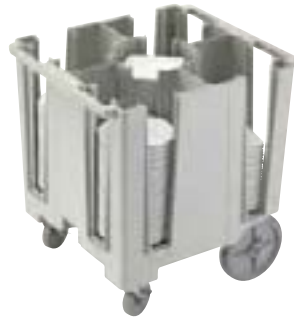

Versa Dish Caddies™

CODE	DCS950	DCS1125
PLATE SIZE RANGE (ROUNDS)	21,3 - 24,1 cm	24,4 - 28,6 cm
PLATE SIZE RANGE (SQUARES)	18,4 - 20,5 cm	21,3 - 24,1 cm
COLUMNS PER CADDY	5, 45-60 plates per col.	4, 45-60 plates per col.
OVERALL DIMENSIONS W x L x H	69 x 78 x 81 cm	69 x 78 x 81 cm

Case Pack: 1

Vinyl cover included with every dolly for sanitary storage.



Poker Chip Style Dish Caddies

CODE	DC575	DC700	DC825
PLATE SIZE RANGE	14,6 cm	14,9 - 17,8 cm	18,1 - 21 cm
COLUMNS PER CADDY	6, 45-60 plates per col.	6, 45-60 plates per col.	4, 45-60 plates per col.
OVERALL DIMENSIONS W x L x H	83 x 60 x 81 cm	83 x 60 x 81 cm	73 x 60,5 x 81,5 cm

Case Pack: 1



Poker Chip Style Dish Caddies

CODE	DC1225
PLATE SIZE RANGE	28,9 - 31,1 cm
COLUMNS PER CADDY	4, 45-60 plates per col.
OVERALL DIMENSIONS W x L x H	83 x 70 x 81,5 cm

Case Pack: 1

Adjustable Tray & Dish Cart



CODE	TDC30
NUMBER OF DIVIDERS	2
PLATES PER COLUMN	Approximately 45-60
TRAYS PER COLUMN	80 Trays: 36 x 46 cm
OVERALL DIMENSIONS W x L x H	59 x 99 x 88 cm
INTERNAL DIMENSIONS W x D	78,7 x 46 cm (no dividers)

Case Pack: 1

CAMBOX® BUSSING BOXES



Regal (ABS)



CODE	1120CBR	1520CBR
DESCRIPTION	Four compartment cutlery box	Cambox
DIM. W x L x H	28,9 x 52 x 9,5 cm	38,9 x 50,6 x 12,5 cm

Case Pack: 12 Colors: Black (110), Dark Brown (131).



CODE	21155CBR	21157CBR	1722CBR
DESCRIPTION	Cambox	Cambox	Cambox
DIM. W x L x H	38,7 x 51,4 x 12,5 cm (incl. handle)	38,6 x 51,2 x 17,6 cm	42,9 x 55,6 x 12,1 cm

Case Pack: 12 Colors: Black (110), Dark Brown (131).

Polyethylene



CODE	415CBP	912CBP	1120CBP	1520CBP & 1520CBPF*
DESCRIPTION	Cutlery Box	Utility Box	Four compartment cutlery box	Cambox
DIM. W x L x H	11,3 x 36 x 10,3 cm	23 x 30,6 x 13 cm	28,9 x 52 x 9,5 cm	38,9 x 50,6 x 12,5 cm

Case Pack: 12 Colors: Black (110), Dark Brown (131), Light Grey (180). *1520CBPF is identical to our current 1520CBP except the internal surface is flat.



CODE	1621CBP	21155CBP	21157CBP	1722CBP
DESCRIPTION	Cambox	Cambox	Cambox	Cambox
DIM. W x L x H	39,7 x 52 x 12,4 cm	38,7 x 51,4 x 12,5 cm (incl. handle)	38,6 x 51,2 x 17,6 cm	42,9 x 55,6 x 12,1 cm

Case Pack: 12 Colors: Black (110), Dark Brown (131), Light Grey (180).

Box Covers



CODE	1520CBCP	1722CBCP	2115CBCP	2115CBCR
FITS	1520CBP	1722CBR, 1722CBP	21155CBP, 21157CBP	2115CBR, 21157CBR
DIM. W x L	40,6 x 52 cm	44 x 56,8 cm	39,4 x 52 cm	39,4 x 52 cm

Case Pack: 12 Color: White (148).



KD SERVICE CART AND KD UTILITY CART

- Versatile, durable and economically-priced carts.
- Marine rails and lightly-textured polypropylene shelves keep contents in place.
- Aluminum uprights ensure stability.
- Ships “knocked down” to minimize shipping costs.
- Easy to assemble.

Cart and Shelf Panel Set Colors:
Black (110), Speckled Grey (480).

Trash Container and Silverware Holder
Color: Black (110).



Each BC340KD shelf holds one full-sized dish rack or two standard bus boxes.

Optional shelf panels can be added at time of assembly to enclose three sides.

Four powder coated steel swivel casters provide quiet transport and steady maneuvering.

Durable, stain-resistant surface is easy to clean.

Marine rails keep contents in place.

Sturdy aluminum uprights.



STOCK PRODUCTS & COLORS AVAILABLE IN OUR EUROPEAN WAREHOUSE

BC331KD, BC340KD, BC340KDP: (480), (110)
BC331KDTC, BC331KDSH: (110)



CODE	BC331KD	BC340KD
DESCRIPTION	Service cart	Large utility cart
CASTER DIA./TYPE	10,2 cm, 4 swivel, no brake	12,7 cm, 4 swivel, no brake
OVERALL DIM. L x D x H	83,5 x 41 x 96,5 cm	101,5 x 54 x 95 cm
SHELF DIM. L x D x H	62 x 40 x 30 cm	80 x 52 x 29,8 cm
LOAD CAPACITY	136 kg	180 kg

Case Pack: 1

Optional Accessories



CODE	BC331KDTC	BC331KDSH	BC340KDP
DESCRIPTION	30 L Trash container	9,5 L Silverware holder	Single shelf panel set (for BC340KD only)
DIM. W x D x H	33 x 24 x 56 cm	33 x 24 x 18,5 cm	80,3 x 45 x 29,8 cm

Case Pack: 1



Shown with optional shelf panels on single shelf.

SERVICE CARTS

- All-purpose versatile, durable and dependable workhorses.
- Ideal for use on the receiving dock or setting up and bussing tables.
- Made of one-piece, polyethylene with molded-in handles and shelves.
- Choose from models with open or enclosed sides.

Colors: Black (110), Slate Blue (401), Dark Brown (131), Coffee Beige (157), Granite Grey (191).

BC225, BC2254S, BC11TC and BC1115SH can be shipped by parcel carrier.



Open Carts

CODE	BC225	BC2254S	BC235
CASTER DIA./TYPE	7,6 cm, 2 fixed, 2 swivel, 1 w/brake	7,6 cm, 4 swivel, 1 w/brake	12,7 cm, 2 fixed, 2 swivel, 1 w/brake
OVERALL DIM. L x D x H	71 x 41 x 82 cm	71 x 41 x 82 cm	95 x 55 x 88 cm
SHELF DIM. L x D x H	56 x 39,5 x 29 cm	56 x 39,5 x 29 cm	79 x 52 x 29 cm
LOAD CAPACITY	159 kg	159 kg	227 kg

Case Pack: 1



CODE	BC2354S	BC230	BC2304S
CASTER DIA./TYPE	12,7 cm, 4 swivel, 1 w/brake	12,7 cm, 2 fixed, 2 swivel, 1 w/brake	12,7 cm, 4 swivel, 1 w/brake
OVERALL DIM. L x D x H	95 x 55 x 88 cm	84,5 x 51 x 88 cm	84,5 x 51 x 88 cm
SHELF DIM. L x D x H	79 x 52 x 29 cm	69 x 49,5 x 29 cm	69 x 49,5 x 29 cm
LOAD CAPACITY	227 kg	227 kg	227 kg

Case Pack: 1

Enclosed Carts



CODE	BC330	BC3304S
CASTER DIA./TYPE	12,7 cm, 2 fixed, 2 swivel 1 w/brake	12,7 cm, 4 swivel, 1 w/brake
OVERALL DIM. L x D x H	84,5 x 51 x 88 cm	84,5 x 51 x 88 cm
SHELF DIM. L x D x H	69 x 46,5 x 29 cm	69 x 46,5 x 29 cm
LOAD CAPACITY	227 kg	227 kg

Case Pack: 1

Optional Accessories



CODE	BC11TC*	BC1115SH*
DESCRIPTION	42 L Trash container	6,6 L Silverware holder
DIMENSIONS W x D x H	35 x 20,6 x 53,7 cm	36,8 x 15,2 x 13,7 cm

Case Pack: 1 *BC11TC & BC1115SH will not fit KD Service or Utility Carts. BC11TC & BC1115SH are available in Black (110) and Dark Brown (131) only.



SHELVING

Key Features of Camshelving® Series

Camshelving Series Quick Reference Guide

Product Code Reference Guide

Free Camshelving Design Service

**Camshelving Series Overall Length –
Quick Reference Guide**

Camshelving Premium Series

Premium Series Weight Bearing Chart

Premium Series Accessories

High Density Storage Floor Track System

Camshelving Elements Series

Elements Series Weight Bearing Chart

Elements Series Accessories

Camshelving Basics Plus Series

Basics Plus Series Weight Bearing Chart

Basics Plus Series Accessories

**Camshelving Wall Shelves And StoreSafe®
Shelf Extenders**

Dunnage Racks

Shelving for Life

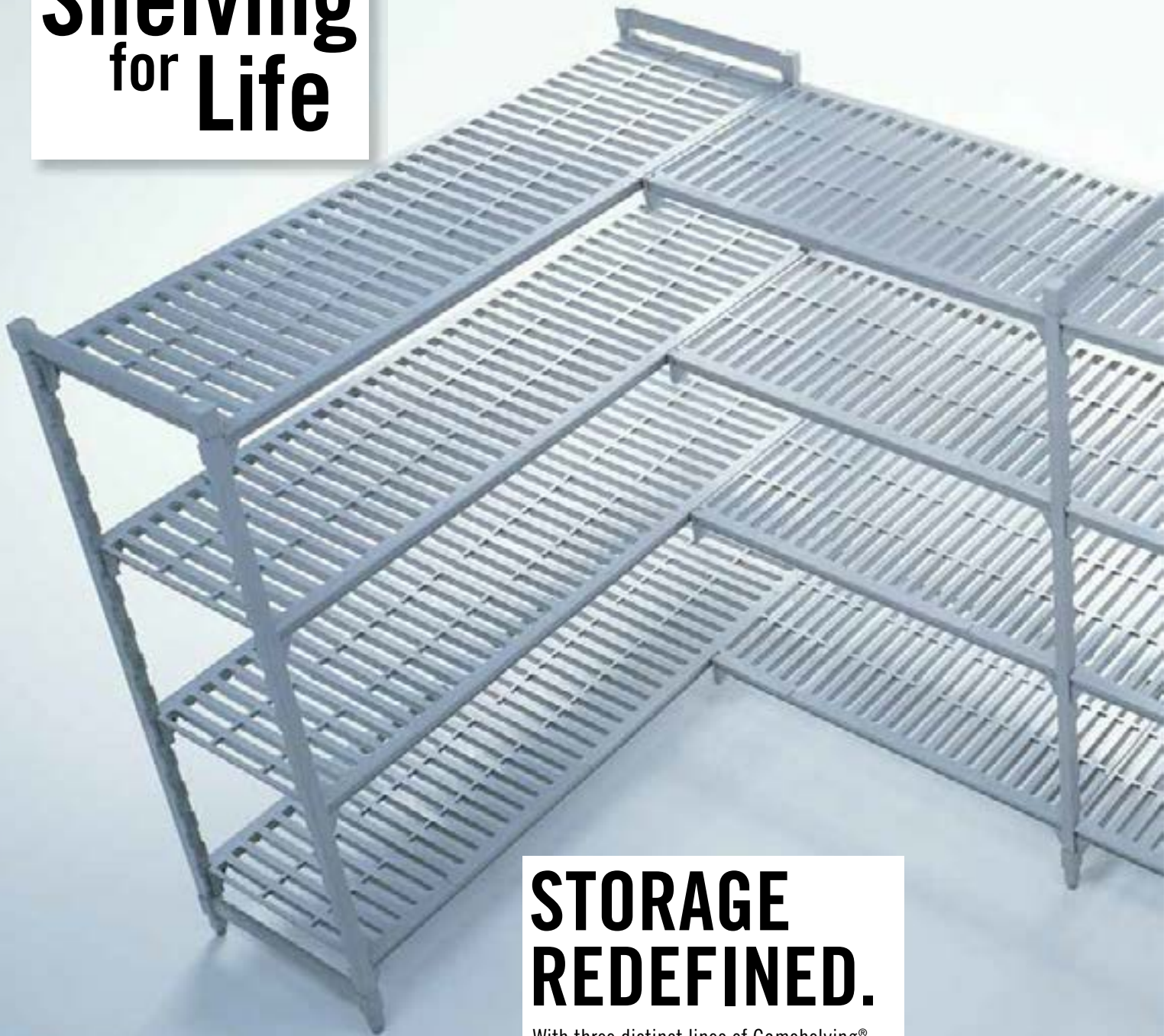

STORAGE REDEFINED.

With three distinct lines of Camshelving[®], all kitchens are created equal!

Every foodservice operation deserves to be set up for maximized cost savings, space efficiency, sanitation, food safety and functionality no matter what the size or budget.

Camshelving storage systems make it all possible, helping foodservice operators optimize organization, support food safety, improve labor savings, simplify inventory management, reduce food waste, and eliminate replacement costs.



Cambo storage and transportation products that support safe food handling.



COMPONENT

Products that meet the NSF International criteria for sanitation and cleanability.



Certifies products approved by Technischer Überwachungs-Verein. (Technical Inspection Association)



Products that help meet HACCP guidelines.



Fit for food products



Dishwasher Safe



Cadmium-free products



Recyclable polypropylene

Camshelving is covered under the following US Patents:

D498,664 S, D508,646 S, D512,867 S, D623,929 S, D624,764 S, D648,582 S, D630,935 S, D648,159 S, D651,433 S, D648,160 S, D697,391 S, D727,715 S, D728,347 S, D728,348 S, D707,994 S, D739,989 S, D663,912 S, D736,488 S, D739,989 S, D760,519 S, US 6,981,454B2

camguard
ANTIMICROBIAL SHELF PLATES

Antimicrobial protection permanently molded into shelf plates to inhibit the growth of mold, fungus and bacteria.

CAMSHELVING®

KEY FEATURES OF ALL CAMSHELVING SERIES

Rust and Corrosion Free

Backed by a lifetime warranty against rust and corrosion, Camshelving storage systems eliminate the inconvenience and costs associated with restoring or replacing degraded shelving. Only Cambro offers Shelving for Life.



Multi Environment Use

Camshelving storage systems are designed to withstand all extreme storage applications and temperatures — impervious to moisture, chemicals, salt, food acids, and humidity. Camshelving systems can be installed anywhere and will never rust.

-38°C TO 88°C



Maximized Space Utilization

Components have been thoughtfully designed to maximize storage space, even in space-restricted areas.

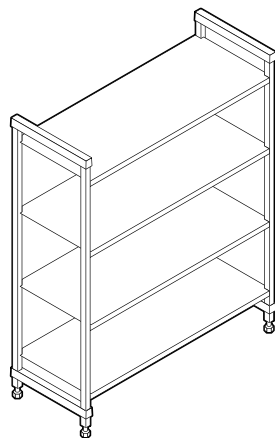

Starter Unit

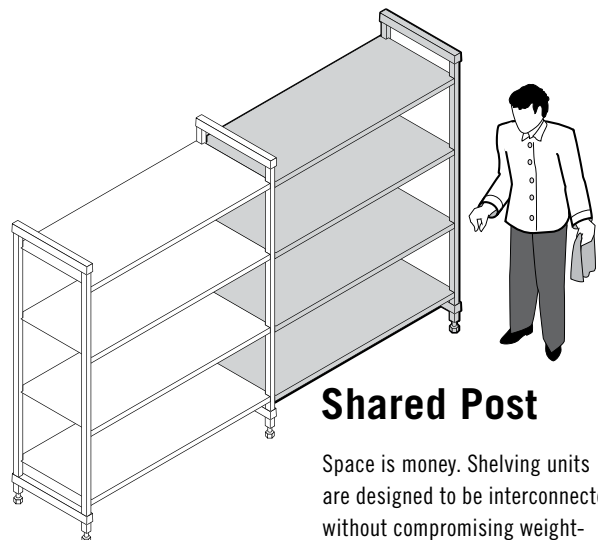

Shared Post

Space is money. Shelving units are designed to be interconnected, without compromising weight-bearing capacity all while maximizing usable storage space.

PREMIUM series

ELEMENTS series



BASICS PLUS series

Easy to Clean

Cleaning shelving shouldn't be a major production. Whether daily or scheduled, cleaning can be done quickly and easily without interrupting storage space or normal, day-to-day operations.



Easy to Adjust

Each shelf can be easily and independently adjusted to accommodate a variety of storage products and packages as product and storage needs change.

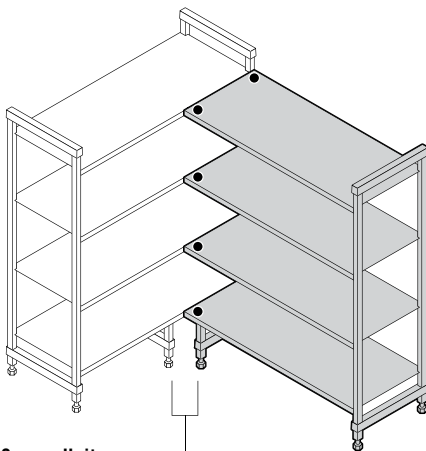

Corner Unit
Starter + Add-On Unit using 1 set of Corner Connectors per shelf and 2 Dunnage Stands.

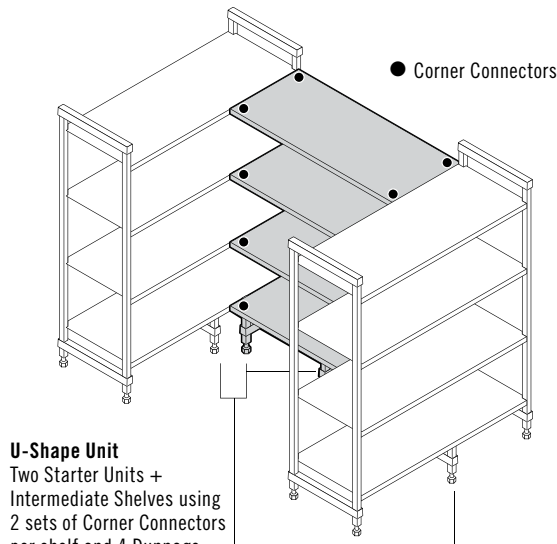

U-Shape Unit
Two Starter Units + Intermediate Shelves using 2 sets of Corner Connectors per shelf and 4 Dunnage Stands.

Corner Shelf Space

Convert unusable space into continuous, easy-access storage areas using corner connectors.

CAMSHELVING® SERIES

QUICK REFERENCE GUIDE

Cambro offers three rust-free, non-corrosive, hygienic shelving systems that will hold up to the tough demands of commercial foodservice operations. This guide will help you choose the ideal Camshelving system for each storage area in your operation. Only Cambro offers Shelving for Life.



PREMIUM series

Storage Areas	High-volume foodservice operations with constant loading and off-loading of heavy products. Frequent and/or multiple daily deliveries. Wet Storage – Walk-in Freezers, Coolers, Warewashing Areas Dry Storage – Bulk Foods, Catering Equipment, China/Dishware, Linen, Merchandising.
Recommended For	Hotels and Casinos, Restaurants, Quick-Serve Restaurants, Schools, Colleges and Universities, Healthcare, Military, Convention Centers/Stadiums, Cruise Ships, Caterers and Banquet Centers, Corporate Dining, Convenience and Grocery Stores.
Product Material	Posts and traverses are made from a steel core with smooth polypropylene exterior. Superior strength and durable enough to withstand the heaviest loading demands.
Assembly	Molded in dovetails means fewer parts, making it the easiest to assemble.
Weight-Bearing Capacity (Premium based on 680 - 1280 mm length) (Elements based on 610 - 1220 mm length) (Basics Plus based on 765 - 1220 mm length)	Stationary Unit: 200 kg per shelf, 800 kg per unit. Mobile Unit: 340 kg per unit. Corner and U-Shape Unit: 180 kg per shelf, 810 kg per unit.
Lifetime Warranty Against Rust & Corrosion	Shelf Plates, Posts and Traverses
Unit Lengths	680, 780, 880, 980, 1080, 1180, 1280, 1380, 1480, 1580, 1680, 1780 mm
Unit Depths	300, 400, 500, 600 mm
Unit Heights	Stationary: 1700, 1800, 2140 mm Mobile: 1790 mm (includes casters)
Mobile Units	YES
High Density Storage Floor Track System	YES
Bottom Shelf Dunnage Stand	YES
Shelf Rails	YES
Vertical Drying and Storage Cradle (Trays / Cutting Boards / Lids)	YES
Dome Drying and Storage Cradle	NO
Angled Drying and Storage Cradle	YES
Shelf Divider (Narrow Item Storage)	YES
Shelf Divider Bar (for Food Pans or Food Boxes)	YES
Single Shelf Sheet Pan / Tray Rack	YES
Single Shelf Security Cage	YES

ACCESSORIES



ELEMENTS series

BASICS PLUS series

<p>High-volume foodservice operations with constant loading and off-loading of medium to heavy products. 5-7 deliveries per week.</p> <p>Wet Storage – Walk-in Freezers, Coolers, Warewashing Areas Dry Storage – Bulk Foods, Catering Equipment, China/Dishware, Linen, Merchandising.</p>	<p>Medium to light volume foodservice operations with constant loading and off-loading of light to medium products. 2-5 deliveries per week.</p> <p>Wet Storage – Walk-in Freezers, Coolers, Warewashing Areas Dry Storage – Bulk Foods, Catering Equipment, Linen, Merchandising, and Disposables.</p>
<p>Hotels and Casinos, Restaurants, Quick-Serve Restaurants, Schools, Colleges and Universities, Healthcare, Military, Convention Centers/Stadiums, Cruise Ships, Caterers and Banquet Centers, Corporate Dining, Convenience and Grocery Stores.</p>	<p>Hotels and Casinos, Restaurants, Quick-Serve Restaurants, Schools, Colleges and Universities, Healthcare, Convention Centers/Stadiums, Caterers and Banquet Centers, Corporate Dining, Convenience Stores, Yogurt Shops and Cafés.</p>
<p>Posts and traverses are made from a revolutionary composite material that is light in weight yet strong enough to withstand rigorous loading conditions.</p>	<p>Posts and traverses are made from the same revolutionary composite material as Elements Series. Slim design is lighter in weight, yet durable and strong enough to withstand a wide variety of storage conditions.</p>
<p>Easy to assemble.</p>	<p>Easy to assemble.</p>
<p>Stationary Unit: 363 kg per shelf, 907 kg per unit. Mobile Unit: 340 kg per unit. Corner and U-Shape Unit: 185 kg per shelf, 820 kg per unit.</p>	<p>Stationary Unit: 190 kg per shelf, 800 kg per unit. Corner and U-Shape Unit: 134 kg per shelf, 590 kg per unit.</p>
<p>Shelf Plates, Posts and Traverses</p>	<p>Shelf Plates, Posts and Traverses</p>
<p>610, 765, 915, 1070, 1220, 1375, 1525, 1830 mm</p>	<p>765, 915, 1070, 1220, 1375, 1525, 1830 mm</p>
<p>360, 460, 540, 610 mm</p>	<p>360, 460, 540, 610 mm</p>
<p>Stationary: 1630, 1830, 2140 mm Mobile: 1778, 1980 mm (includes casters)</p>	<p>Stationary: 1630, 1830, 2140 mm</p>
<p>YES</p>	<p>NO</p>
<p>NO</p>	<p>NO</p>
<p>YES</p>	<p>YES</p>
<p>YES</p>	<p>NO</p>
<p>YES</p>	<p>YES</p>
<p>YES</p>	<p>NO</p>
<p>YES</p>	<p>YES</p>
<p>YES</p>	<p>YES</p>
<p>YES</p>	<p>NO</p>
<p>YES</p>	<p>YES</p>
<p>YES</p>	<p>YES</p>

PRODUCT CODE REFERENCE GUIDE

Cambro's product codes are simple, making it easy to identify the type of unit or accessory required. Code numbers are composed of 3 parts.

1. **Prefix** – Defines the shelving brand and type of unit being selected.
2. **Dimensions** – Identifies the depth, length and height.
3. **Suffix** – Type and quantity of shelves.

Complete Units

MP Camshelving® Premium Series

- MPU Stationary Starter Unit
- MPA Stationary Add-On Unit
- MPMU Mobile Unit
- MPHU High Density Mobile Unit

E Camshelving Elements Series

- ESU Stationary Starter Unit
- EA Stationary Add-On Unit
- EMU Mobile Unit

CB Camshelving Basics Plus Series

- CBU Stationary Starter Unit
- CBA Stationary Add-On Unit

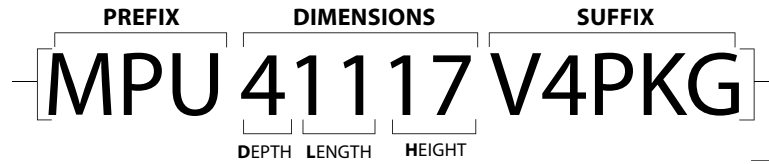

Example of a code for a Camshelving Premium Starter Unit D 40 x L 110 x H 170 cm with 4 Vented Shelves.

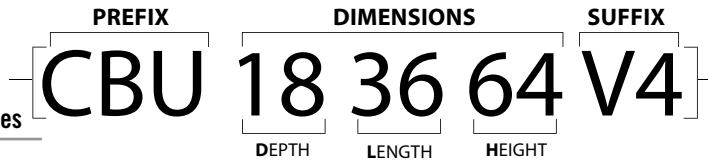

Example of a code for a Camshelving Basics Plus Starter Unit D 18" x L 36" x H 64" (D 46 x L 91 x H 163 cm) with 4 Vented Shelves.

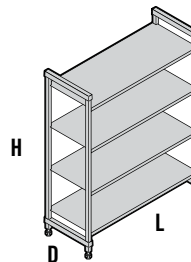

V4 4 Vented Shelves

V5 5 Vented Shelves

S4 4 Solid Shelves

S5 5 Solid Shelves

VS4 3 Vented Shelves + 1 Solid Shelf

VS5 4 Vented Shelves + 1 Solid Shelf

V4PKG* 4 Vented Shelves

V5PKG* 5 Vented Shelves

S4PKG* 4 Solid Shelves

VS4PKG* 3 Vented Shelves + 1 Solid Shelf

*Premium Series only.

Post Kits and Shelf Kits

MP Camshelving® Premium Series

- MPSK Stationary Shelf Kit
- MPPK Stationary Post Kit
- MPMPK Mobile Post Kit

E Camshelving Elements Series

- ESK Stationary Shelf Kit
- EPK Stationary Post Kit
- EMSK Mobile Shelf Kit
- EMPK Mobile Post Kit

CB Camshelving Basics Plus Series

- CBSK Stationary Shelf Kit
- CBPK Stationary Post Kit

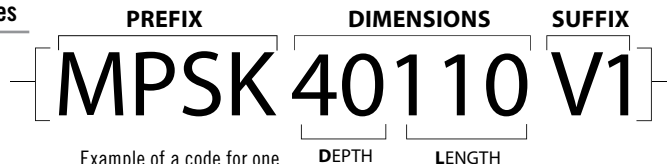

Example of a code for one Camshelving Premium Stationary Vented Shelf Kit D 40 x L 110 cm in one carton.

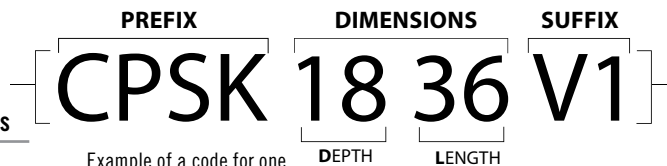

Example of a code for one Camshelving Basics Plus Stationary Vented Shelf Kit D 18" x L 36" (D 46 x L 91 cm) in one carton.

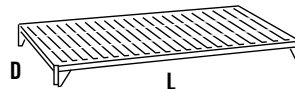

V1 1 Vented Shelf

S1 1 Solid Shelf

V4 4 Vented Shelves

V5 5 Vented Shelves

S4 4 Solid Shelves

S5 5 Solid Shelves

VS4* 3 Vented Shelves + 1 Solid Shelf

VS5* 4 Vented Shelves + 1 Solid Shelf

*Elements and Basics Plus Series only.

Accessories

If an accessory is used by more than 1 line of shelving, the code will start with CS. If an accessory is only used in one line of shelving, the code will start by the prefix letters of the line. Example: Corner Connectors:

- a. MPCC1 = Camshelving Premium Corner Connector Set
- b. ECC1 = Camshelving Elements Corner Connector Set
- c. CBCC1 = Camshelving Basics Plus Corner Connector Set

FREE CAMSHELVING® DESIGN SERVICE

In order to select the most suitable and cost effective storage system, Cambro offers customized shelving illustrations using our proprietary shelving design program. Space allocation, operational flow and organizational challenges are quickly addressed when selecting the right product for the storage application. Usable storage space is maximized using the least number of units to help operators manage equipment costs.

Once all required information is received, our expert shelving consultants prepare a 2D and 3D recommended floor plan along with an itemized product list by room/area. Proposals are completed and emailed within 24-48 business day hours, depending on number of rooms and complexity.

We look forward to designing the perfect storage solution for you. Call or email today to connect with one of our Camshelving consultants.

CAMBRO USA: 1(714) 230-4113
shelving@cambro.com

CAMBRO EUROPEAN LOGISTICS: (49)7022 90 100 0
cambroeuropa@cambro.com

CAMBRO UK: 0800 587 0057 (Toll Free)
cambrouk@cambro.com

CAMBRO IRELAND: 1 800 509 046 (Toll Free)
cambroireland@cambro.com

It's Simple! To Get Started, Please Provide:

- Project Name
- Storage Room Type (freezer / cooler)
- Room(s) Dimensions (L x W x H)
- Doorway / Entryway Location & Dimension
- Obstructions (condenser / pipes)
- Additional Preferences / Requirements

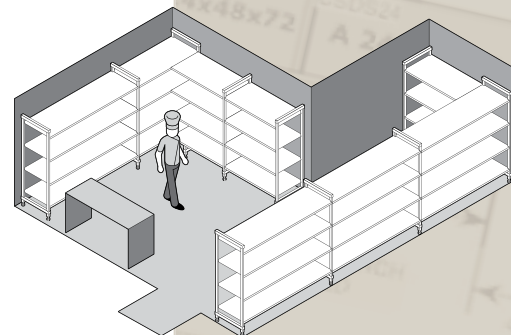
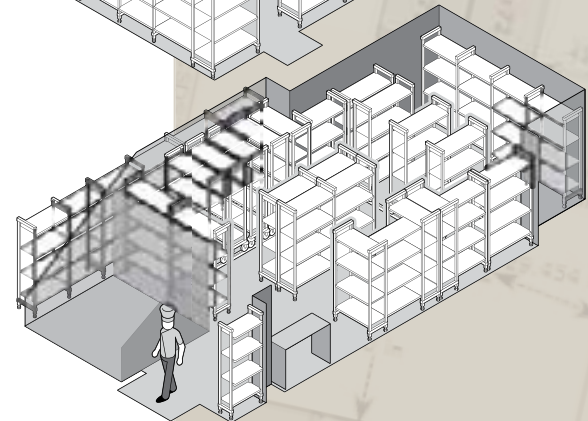
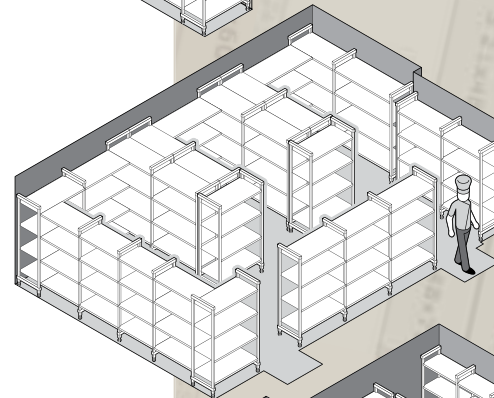
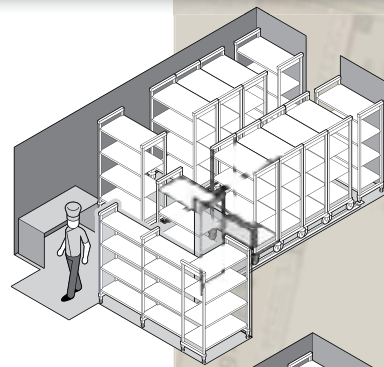

CAMSHELVING® SERIES OVERALL LENGTH – QUICK REFERENCE GUIDE

Straight Unit: Starter Unit + Add-On Unit with Shared Posts

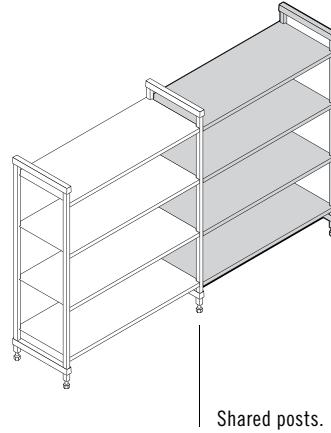
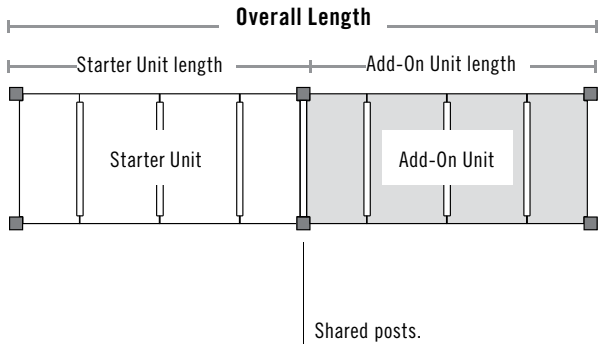

Corner Unit: Starter Unit + Add-On Unit with Corner Connectors

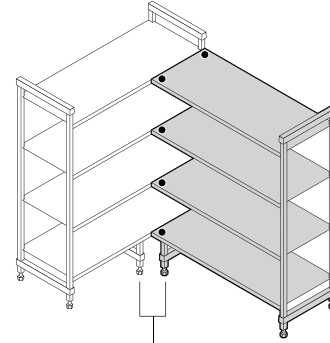
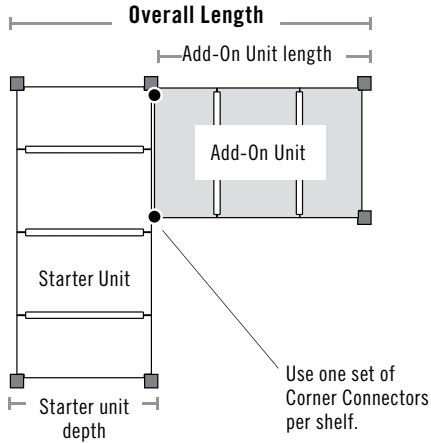

Use one Dunnage Stand under each Starter and Add-On Unit.

U-Shape Unit: Two Starter Units + Intermediate Shelves with Corner Connectors

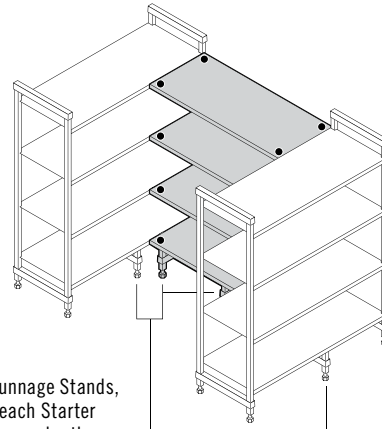
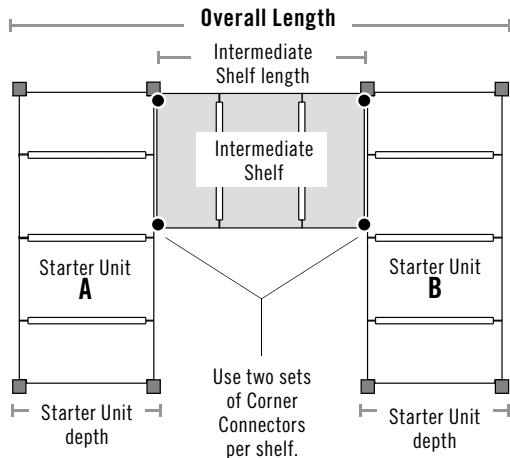

Use four Dunnage Stands, one under each Starter Unit and two under the bottom Intermediate Shelf.

Straight Unit: Starter Unit + Add-On Unit with Shared Posts

PREMIUM SERIES				ELEMENTS SERIES				BASICS PLUS SERIES			
STARTER & ADD-ON UNIT	STARTER UNIT ACTUAL LENGTH	ADD-ON UNIT ACTUAL LENGTH	OVERALL LENGTH	STARTER UNIT ACTUAL LENGTH	ADD-ON UNIT ACTUAL LENGTH	OVERALL LENGTH	STARTER UNIT ACTUAL LENGTH	ADD-ON UNIT ACTUAL LENGTH	OVERALL LENGTH		
600 mm	680 mm	+ 635 mm	= 1315 mm	610 mm	+ 559 mm	= 1169 mm	765 mm	+ 718 mm	= 1483 mm		
700	780	+ 735	= 1515	765	+ 712	= 1477	915	+ 870	= 1785		
800	880	+ 835	= 1715	915	+ 864	= 1779	1070	+ 1023	= 2093		
900	980	+ 935	= 1915	1070	+ 1016	= 2086	1220	+ 1175	= 2395		
1000	1080	+ 1035	= 2115	1220	+ 1169	= 2389	1375	+ 1328	= 2703		
1100	1180	+ 1135	= 2315	1375	+ 1321	= 2696	1525	+ 1480	= 3005		
1200	1280	+ 1235	= 2515	1525	+ 1474	= 2999					
1300	1380	+ 1335	= 2715	1830	+ 1778	= 3608					
1400	1480	+ 1435	= 2915								
1500	1580	+ 1535	= 3115								
1600	1680	+ 1635	= 3315								
1700	1780	+ 1735	= 3515								

Corner Unit: Starter Unit + Add-On Unit with Corner Connectors

PREMIUM SERIES				PREMIUM SERIES				PREMIUM SERIES			
ADD-ON UNIT	ADD-ON UNIT ACTUAL LENGTH	STARTER UNIT DEPTH	OVERALL LENGTH	ADD-ON UNIT ACTUAL LENGTH	STARTER UNIT DEPTH	OVERALL LENGTH	ADD-ON UNIT ACTUAL LENGTH	STARTER UNIT DEPTH	OVERALL LENGTH		
600 mm	655 mm	+ 400 mm	= 1035 mm	655 mm	+ 500 mm	= 1155 mm	655 mm	+ 600 mm	= 1255 mm		
700	755	+ 400	= 1135	755	+ 500	= 1255	755	+ 600	= 1355		
800	855	+ 400	= 1235	855	+ 500	= 1355	855	+ 600	= 1455		
900	955	+ 400	= 1335	955	+ 500	= 1455	955	+ 600	= 1555		
1000	1055	+ 400	= 1435	1055	+ 500	= 1555	1055	+ 600	= 1655		
1100	1155	+ 400	= 1535	1155	+ 500	= 1655	1155	+ 600	= 1755		
1200	1255	+ 400	= 1635	1255	+ 500	= 1755	1255	+ 600	= 1855		
ELEMENTS / BASICS PLUS SERIES				ELEMENTS / BASICS PLUS SERIES				ELEMENTS / BASICS PLUS SERIES			
610	585	+ *458	= 1045	585	+ *534	= 1119	585	+ *610	= 1195		
765	737	+ 458	= 1200	737	+ 534	= 1271	737	+ 610	= 1347		
915	889	+ 458	= 1350	889	+ 534	= 1423	889	+ 610	= 1499		
1070	1042	+ 458	= 1505	1042	+ 534	= 1576	1042	+ 610	= 1652		
1220	1194	+ 458	= 1655	1194	+ 534	= 1728	1194	+ 610	= 1804		

610 mm unit not available in Camshelving Basics Plus Series. *Actual depth.

U-Shape Unit: Two Starter Units + Intermediate Shelves with Corner Connectors

PREMIUM SERIES				PREMIUM SERIES				PREMIUM SERIES			
INTERMEDIATE SHELF	INTERMEDIATE SHELF ACTUAL LENGTH	400 MM DEPTH STARTER UNIT A+B	OVERALL LENGTH	INTERMEDIATE SHELF ACTUAL LENGTH	500 MM DEPTH STARTER UNIT A+B	OVERALL LENGTH	INTERMEDIATE SHELF ACTUAL LENGTH	600 MM DEPTH STARTER UNIT A+B	OVERALL LENGTH		
800 mm	830 mm	+ 800 mm	= 1630 mm	830 mm	+ 1000 mm	= 1830 mm	830 mm	+ 1200 mm	= 2030 mm		
900	930	+ 800	= 1730	930	+ 1000	= 1930	930	+ 1200	= 2130		
1000	1030	+ 800	= 1830	1030	+ 1000	= 2030	1030	+ 1200	= 2230		
1100	1130	+ 800	= 1930	1130	+ 1000	= 2130	1130	+ 1200	= 2330		
1200	1230	+ 800	= 2030	1230	+ 1000	= 2230	1230	+ 1200	= 2430		
ELEMENTS / BASICS PLUS SERIES				ELEMENTS / BASICS PLUS SERIES				ELEMENTS / BASICS PLUS SERIES			
915 mm	864 mm	+ *915 mm	= 1779 mm	864 mm	+ *1067 mm	= 1931 mm	864 mm	+ *1220 mm	= 2084 mm		
1070	1016	+ 915	= 1931	1016	+ 1067	= 2083	1020	+ 1220	= 2236		
1220	1169	+ 915	= 2084	1169	+ 1067	= 2236	1170	+ 1220	= 2389		

*Actual depth.

CAMSHELVING® PREMIUM series

WHY CHOOSE PREMIUM?

In high volume foodservice operations with frequent deliveries and constant loading and off-loading of products, stability, strength and sanitary storage should never be compromised. Premium Series does precisely what it was designed to do – hold the heaviest products with the roughest handling, in any environment and it is the easiest to clean and adjust.

Only available from Cambro European Logistics (CEL), Germany and Cambro Üzay Turkey.

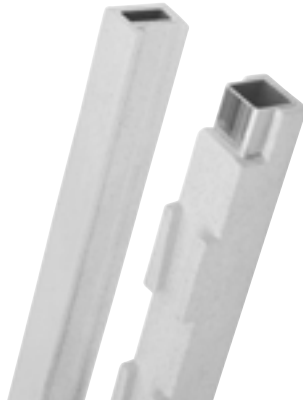

All Environments
-38°C TO 88°C

Stationary

High Density

Mobile

camguard
ANTIMICROBIAL SHELF PLATES



COMPONENT

storage needs
HEAVY

daily deliveries
FREQUENT

Posts, Traverses, Shelf Plates, Dunnage Stand Saddle, Post Connectors, Corner Connectors, Seismic Foot, Wall Fastener, Identification Tags, Single Shelf Security Cage, Tray Slide Rack, Shelf Rails, Shelf Divider Bars, High Density Track and Extension Kits are not NSF Listed.

CAMSHELVING® PREMIUM SERIES STATIONARY UNIT SIZES

MOBILE UNIT SIZES

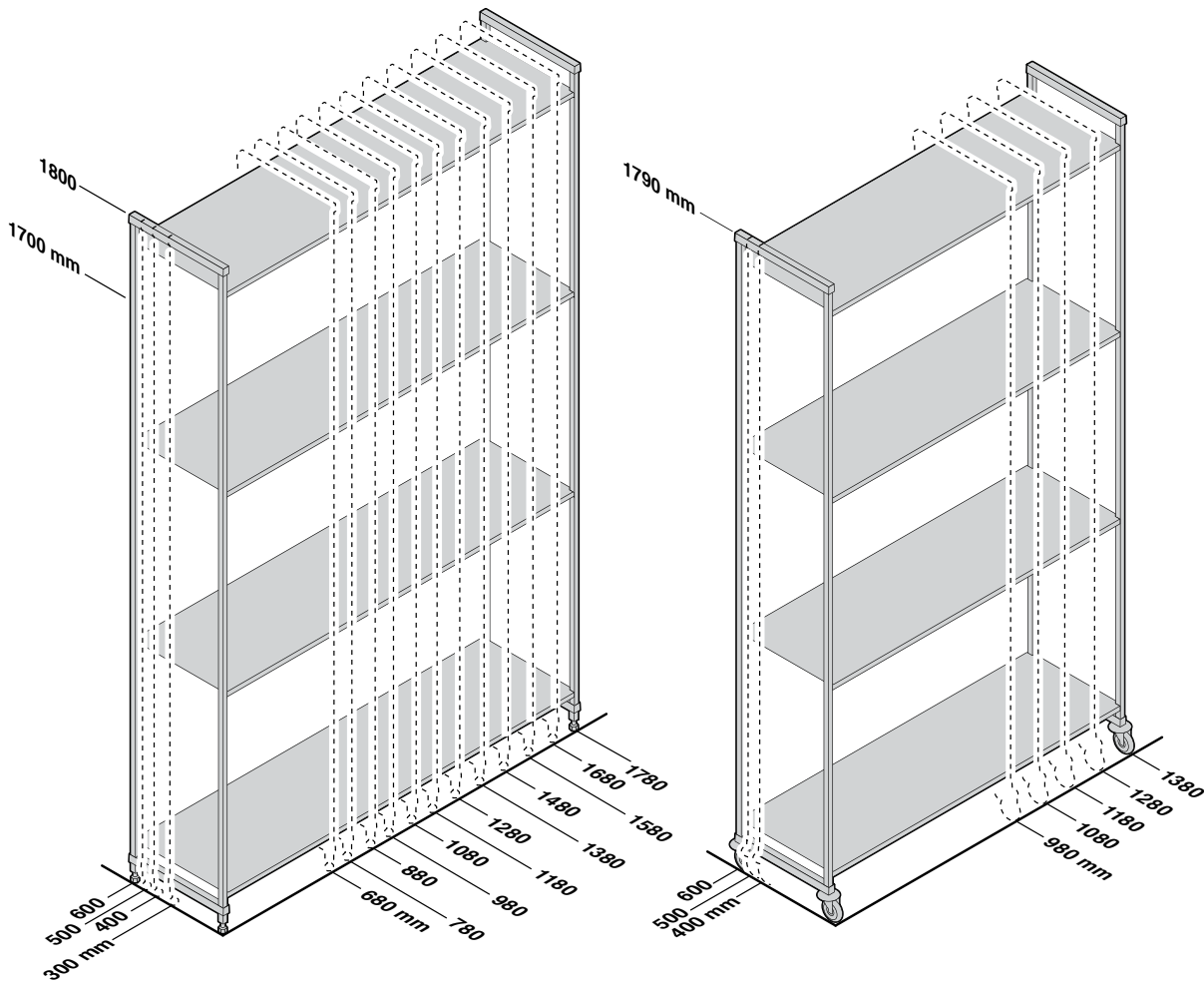

PREMIUM SERIES WEIGHT BEARING CAPACITY

Weight must be evenly distributed across the entire shelf.

		UNIT LENGTH	UNIT LENGTH
		680 – 1280 MM	1380 – 1780 MM
SINGLE UNIT	Unit only	800 kg (TUV)	600 kg (TUV)
	Shelf only	200 (TUV)	150 (TUV)
	Unit with dunnage stand*	980	740
	Bottom shelf with dunnage stand*	380	290
CORNER UNIT with 2 dunnage stands required	Unit only	810	—
	Shelf only	180	—
	Bottom shelf with dunnage stands*	270	—
MOBILE UNIT	Unit only**	340	—

**Due to the weight bearing capacity of casters, maximum weight load on an entire Mobile Unit is 340 kg.



**TUV CERTIFICATION
WEIGHT BEARING CAPACITY**

*Dunnage Stands add stability and increase weight bearing capacity on bottom shelf only. Highly recommended for Starter Units 1380 mm and longer, all Corner Units, U-Shape Units and units specified for heavier loads. (See page 96).

CAMSHELVING® PREMIUM SERIES

Starter, Add-On and Mobile Units

These units make ordering easy and save time and labor during installation. Due to unit weight and size, all units ship in multiple boxes of post kits (unassembled) and shelf kits.

Only available from Cambro European Logistics (CEL), Germany and Cambro Özay Turkey.



4-Shelf Vented Stationary Starter and Add-On Units

Starter units include 2 post kits and 4 shelf kits.

Add-On units include 1 post kit and 4 shelf kits.

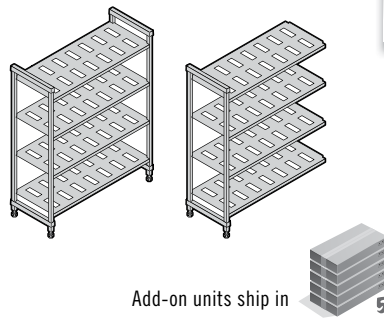

HEIGHTS	DEPTHS	LENGTHS	
2	4	12	
1700 mm	300 mm	680 mm	1280 mm
1800	400	780	1380
	500	880	1480
	600	980	1580
		1080	1680
		1180	1780

Add-on units ship in 5

Starter units ship in 6

4-Shelf Solid Stationary Starter and Add-On Units

Starter units include 2 post kits and 4 shelf kits.

Add-On units include 1 post kit and 4 shelf kits.

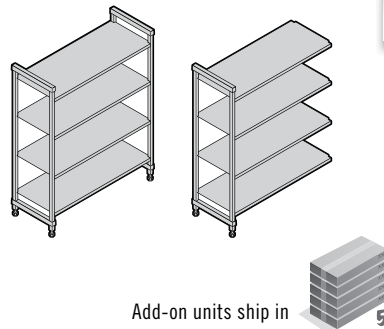

HEIGHTS	DEPTHS	LENGTHS	
2	4	12	
1700 mm	300 mm	680 mm	1280 mm
1800	400	780	1380
	500	880	1480
	600	980	1580
		1080	1680
		1180	1780

Add-on units ship in 5

Starter units ship in 6

4-Shelf Vented and Solid Stationary Starter and Add-On Units (3 vented + 1 solid)

Starter units include 2 post kits and 4 shelf kits.

Add-On units include 1 post kit and 4 shelf kits.

Install solid shelf on bottom to prevent water/cleaning solutions from sloshing up onto stored products. Install solid shelf on top to protect product stored on lower shelves from condensation in cooler.

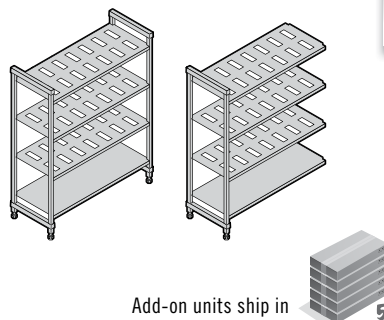

HEIGHTS	DEPTHS	LENGTHS	
2	4	12	
1700 mm	300 mm	680 mm	1280 mm
1800	400	780	1380
	500	880	1480
	600	980	1580
		1080	1680
		1180	1780

Add-on units ship in 5

Starter units ship in 6

5-Shelf Vented Stationary Starter and Add-On Units

Starter units include 2 post kits and 4 shelf kits.

Add-On units include 1 post kit and 4 shelf kits.

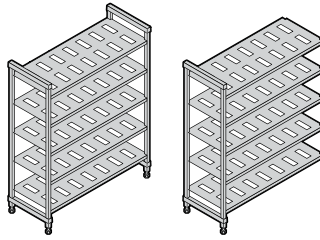

Add-on units ship in



Starter units ship in

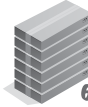

HEIGHTS	DEPTHS	LENGTHS	
2	4	12	
1700 mm	300 mm	680 mm	1280 mm
1800	400	780	1380
	500	880	1480
	600	980	1580
		1080	1680
		1180	1780

4 Shelf Vented or Solid Mobile Starter Units

Mobile starter units include 2 mobile post kits, 4 shelf kits vented or solid and 4 swivel casters with total locking brake.

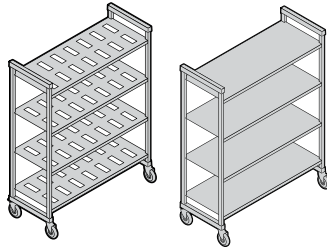

HEIGHT*	DEPTHS	LENGTHS
1	3	5
1790 mm	400 mm	980 mm
	500	1080
	600	1180
		1280
		1380

*Includes 127 mm casters.

ship in

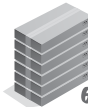

Visit the Camshelving website at www.cambro.com/camshelving for product information, assembly videos and design layouts, or to view or download the Camshelving Specification and Price List.



PREMIUM
SERIES

1700
mm
HEIGHT

V4PKG

4-SHELF VENTED UNITS

Starter units include 2 post kits and 4 shelf kits.
Units ship complete in 6 boxes.

Add-On units include 1 post kit and 4 shelf kits.
Units ship complete in 5 boxes.

Starter

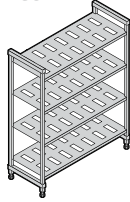

400 mm DEPTH

Add-On

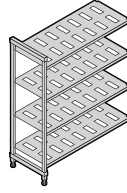

CODE	DIMENSIONS D x L x H
MPU4617V4PKG	400 x 680 x 1700 mm
MPU4717V4PKG	400 x 780 x 1700
MPU4817V4PKG	400 x 880 x 1700
MPU4917V4PKG	400 x 980 x 1700
MPU41017V4PKG	400 x 1080 x 1700
MPU41117V4PKG	400 x 1180 x 1700
MPU41217V4PKG	400 x 1280 x 1700
MPU41317V4PKG	400 x 1380 x 1700
MPU41417V4PKG	400 x 1480 x 1700
MPU41517V4PKG	400 x 1580 x 1700
MPU41617V4PKG	400 x 1680 x 1700
MPU41717V4PKG	400 x 1780 x 1700

CODE	DIMENSIONS D x L x H
MPA4617V4PKG	400 x 635 x 1700 mm
MPA4717V4PKG	400 x 735 x 1700
MPA4817V4PKG	400 x 835 x 1700
MPA4917V4PKG	400 x 935 x 1700
MPA41017V4PKG	400 x 1035 x 1700
MPA41117V4PKG	400 x 1135 x 1700
MPA41217V4PKG	400 x 1235 x 1700
MPA41317V4PKG	400 x 1335 x 1700
MPA41417V4PKG	400 x 1435 x 1700
MPA41517V4PKG	400 x 1535 x 1700
MPA41617V4PKG	400 x 1635 x 1700
MPA41717V4PKG	400 x 1735 x 1700

500 mm DEPTH

MPU5617V4PKG	500 x 680 x 1700 mm
MPU5717V4PKG	500 x 780 x 1700
MPU5817V4PKG	500 x 880 x 1700
MPU5917V4PKG	500 x 980 x 1700
MPU51017V4PKG	500 x 1080 x 1700
MPU51117V4PKG	500 x 1180 x 1700
MPU51217V4PKG	500 x 1280 x 1700
MPU51317V4PKG	500 x 1380 x 1700
MPU51417V4PKG	500 x 1480 x 1700
MPU51517V4PKG	500 x 1580 x 1700
MPU51617V4PKG	500 x 1680 x 1700
MPU51717V4PKG	500 x 1780 x 1700

MPA5617V4PKG	500 x 635 x 1700 mm
MPA5717V4PKG	500 x 735 x 1700
MPA5817V4PKG	500 x 835 x 1700
MPA5917V4PKG	500 x 935 x 1700
MPA51017V4PKG	500 x 1035 x 1700
MPA51117V4PKG	500 x 1135 x 1700
MPA51217V4PKG	500 x 1235 x 1700
MPA51317V4PKG	500 x 1335 x 1700
MPA51417V4PKG	500 x 1435 x 1700
MPA51517V4PKG	500 x 1535 x 1700
MPA51617V4PKG	500 x 1635 x 1700
MPA51717V4PKG	500 x 1735 x 1700

600 mm DEPTH

MPU6617V4PKG	600 x 680 x 1700 mm
MPU6717V4PKG	600 x 780 x 1700
MPU6817V4PKG	600 x 880 x 1700
MPU6917V4PKG	600 x 980 x 1700
MPU61017V4PKG	600 x 1080 x 1700
MPU61117V4PKG	600 x 1180 x 1700
MPU61217V4PKG	600 x 1280 x 1700
MPU61317V4PKG	600 x 1380 x 1700
MPU61417V4PKG	600 x 1480 x 1700
MPU61517V4PKG	600 x 1580 x 1700
MPU61617V4PKG	600 x 1680 x 1700
MPU61717V4PKG	600 x 1780 x 1700

MPA6617V4PKG	600 x 635 x 1700 mm
MPA6717V4PKG	600 x 735 x 1700
MPA6817V4PKG	600 x 835 x 1700
MPA6917V4PKG	600 x 935 x 1700
MPA61017V4PKG	600 x 1035 x 1700
MPA61117V4PKG	600 x 1135 x 1700
MPA61217V4PKG	600 x 1235 x 1700
MPA61317V4PKG	600 x 1335 x 1700
MPA61417V4PKG	600 x 1435 x 1700
MPA61517V4PKG	600 x 1535 x 1700
MPA61617V4PKG	600 x 1635 x 1700
MPA61717V4PKG	600 x 1735 x 1700

PREMIUM
SERIES

1800
mm
HEIGHT

V4PKG

4-SHELF VENTED UNITS

Starter units include 2 post kits and 4 shelf kits.
Units ship complete in 6 boxes.

Add-On units include 1 post kit and 4 shelf kits.
Units ship complete in 5 boxes.

Starter

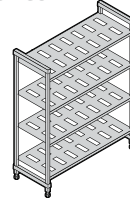

400 mm DEPTH

Add-On

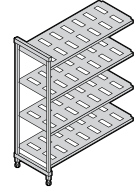

CODE	DIMENSIONS D x L x H
MPU4618V4PKG	400 x 680 x 1800 mm
MPU4718V4PKG	400 x 780 x 1800
MPU4818V4PKG	400 x 880 x 1800
MPU4918V4PKG	400 x 980 x 1800
MPU41018V4PKG	400 x 1080 x 1800
MPU41118V4PKG	400 x 1180 x 1800
MPU41218V4PKG	400 x 1280 x 1800
MPU41318V4PKG	400 x 1380 x 1800
MPU41418V4PKG	400 x 1480 x 1800
MPU41518V4PKG	400 x 1580 x 1800
MPU41618V4PKG	400 x 1680 x 1800
MPU41718V4PKG	400 x 1780 x 1800

CODE	DIMENSIONS D x L x H
MPA4618V4PKG	400 x 635 x 1800 mm
MPA4718V4PKG	400 x 735 x 1800
MPA4818V4PKG	400 x 835 x 1800
MPA4918V4PKG	400 x 935 x 1800
MPA41018V4PKG	400 x 1035 x 1800
MPA41118V4PKG	400 x 1135 x 1800
MPA41218V4PKG	400 x 1235 x 1800
MPA41318V4PKG	400 x 1335 x 1800
MPA41418V4PKG	400 x 1435 x 1800
MPA41518V4PKG	400 x 1535 x 1800
MPA41618V4PKG	400 x 1635 x 1800
MPA41718V4PKG	400 x 1735 x 1800

500 mm DEPTH

MPU5618V4PKG	500 x 680 x 1800 mm
MPU5718V4PKG	500 x 780 x 1800
MPU5818V4PKG	500 x 880 x 1800
MPU5918V4PKG	500 x 980 x 1800
MPU51018V4PKG	500 x 1080 x 1800
MPU51118V4PKG	500 x 1180 x 1800
MPU51218V4PKG	500 x 1280 x 1800
MPU51318V4PKG	500 x 1380 x 1800
MPU51418V4PKG	500 x 1480 x 1800
MPU51518V4PKG	500 x 1580 x 1800
MPU51618V4PKG	500 x 1680 x 1800
MPU51718V4PKG	500 x 1780 x 1800

MPA5618V4PKG	500 x 635 x 1800 mm
MPA5718V4PKG	500 x 735 x 1800
MPA5818V4PKG	500 x 835 x 1800
MPA5918V4PKG	500 x 935 x 1800
MPA51018V4PKG	500 x 1035 x 1800
MPA51118V4PKG	500 x 1135 x 1800
MPA51218V4PKG	500 x 1235 x 1800
MPA51318V4PKG	500 x 1335 x 1800
MPA51418V4PKG	500 x 1435 x 1800
MPA51518V4PKG	500 x 1535 x 1800
MPA51618V4PKG	500 x 1635 x 1800
MPA51718V4PKG	500 x 1735 x 1800

600 mm DEPTH

MPU6618V4PKG	600 x 680 x 1800 mm
MPU6718V4PKG	600 x 780 x 1800
MPU6818V4PKG	600 x 880 x 1800
MPU6918V4PKG	600 x 980 x 1800
MPU61018V4PKG	600 x 1080 x 1800
MPU61118V4PKG	600 x 1180 x 1800
MPU61218V4PKG	600 x 1280 x 1800
MPU61318V4PKG	600 x 1380 x 1800
MPU61418V4PKG	600 x 1480 x 1800
MPU61518V4PKG	600 x 1580 x 1800
MPU61618V4PKG	600 x 1680 x 1800
MPU61718V4PKG	600 x 1780 x 1800

MPA6618V4PKG	600 x 635 x 1800 mm
MPA6718V4PKG	600 x 735 x 1800
MPA6818V4PKG	600 x 835 x 1800
MPA6918V4PKG	600 x 935 x 1800
MPA61018V4PKG	600 x 1035 x 1800
MPA61118V4PKG	600 x 1135 x 1800
MPA61218V4PKG	600 x 1235 x 1800
MPA61318V4PKG	600 x 1335 x 1800
MPA61418V4PKG	600 x 1435 x 1800
MPA61518V4PKG	600 x 1535 x 1800
MPA61618V4PKG	600 x 1635 x 1800
MPA61718V4PKG	600 x 1735 x 1800

STOCK PRODUCTS & COLORS AVAILABLE IN OUR EUROPEAN WAREHOUSE

ALL SIZES: (490)

Color: Speckled White (490).

PREMIUM
SERIES

1800
mm
HEIGHT

V5PKG

5-SHELF VENTED UNITS

Starter units include 2 post kits and 5 shelf kits.
Units ship complete in 7 boxes.

Add-On units include 1 post kit and 5 shelf kits.
Units ship complete in 6 boxes.

Starter

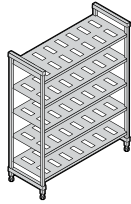

400 mm DEPTH

CODE	DIMENSIONS D x L x H
MPU4618V5PKG	400 x 680 x 1800 mm
MPU4718V5PKG	400 x 780 x 1800
MPU4818V5PKG	400 x 880 x 1800
MPU4918V5PKG	400 x 980 x 1800
MPU41018V5PKG	400 x 1080 x 1800
MPU41118V5PKG	400 x 1180 x 1800
MPU41218V5PKG	400 x 1280 x 1800
MPU41318V5PKG	400 x 1380 x 1800
MPU41418V5PKG	400 x 1480 x 1800
MPU41518V5PKG	400 x 1580 x 1800
MPU41618V5PKG	400 x 1680 x 1800
MPU41718V5PKG	400 x 1780 x 1800

500 mm DEPTH

MPU5618V5PKG	500 x 680 x 1800 mm
MPU5718V5PKG	500 x 780 x 1800
MPU5818V5PKG	500 x 880 x 1800
MPU5918V5PKG	500 x 980 x 1800
MPU51018V5PKG	500 x 1080 x 1800
MPU51118V5PKG	500 x 1180 x 1800
MPU51218V5PKG	500 x 1280 x 1800
MPU51318V5PKG	500 x 1380 x 1800
MPU51418V5PKG	500 x 1480 x 1800
MPU51518V5PKG	500 x 1580 x 1800
MPU51618V5PKG	500 x 1680 x 1800
MPU51718V5PKG	500 x 1780 x 1800

600 mm DEPTH

MPU6618V5PKG	600 x 680 x 1800 mm
MPU6718V5PKG	600 x 780 x 1800
MPU6818V5PKG	600 x 880 x 1800
MPU6918V5PKG	600 x 980 x 1800
MPU61018V5PKG	600 x 1080 x 1800
MPU61118V5PKG	600 x 1180 x 1800
MPU61218V5PKG	600 x 1280 x 1800
MPU61318V5PKG	600 x 1380 x 1800
MPU61418V5PKG	600 x 1480 x 1800
MPU61518V5PKG	600 x 1580 x 1800
MPU61618V5PKG	600 x 1680 x 1800
MPU61718V5PKG	600 x 1780 x 1800

Add-On

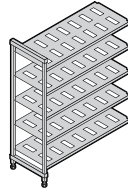

CODE	DIMENSIONS D x L x H
MPA4618V5PKG	400 x 635 x 1800 mm
MPA4718V5PKG	400 x 735 x 1800
MPA4818V5PKG	400 x 835 x 1800
MPA4918V5PKG	400 x 935 x 1800
MPA41018V5PKG	400 x 1035 x 1800
MPA41118V5PKG	400 x 1135 x 1800
MPA41218V5PKG	400 x 1235 x 1800
MPA41318V5PKG	400 x 1335 x 1800
MPA41418V5PKG	400 x 1435 x 1800
MPA41518V5PKG	400 x 1535 x 1800
MPA41618V5PKG	400 x 1635 x 1800
MPA41718V5PKG	400 x 1735 x 1800

MPA5618V5PKG	500 x 635 x 1800 mm
MPA5718V5PKG	500 x 735 x 1800
MPA5818V5PKG	500 x 835 x 1800
MPA5918V5PKG	500 x 935 x 1800
MPA51018V5PKG	500 x 1035 x 1800
MPA51118V5PKG	500 x 1135 x 1800
MPA51218V5PKG	500 x 1235 x 1800
MPA51318V5PKG	500 x 1335 x 1800
MPA51418V5PKG	500 x 1435 x 1800
MPA51518V5PKG	500 x 1535 x 1800
MPA51618V5PKG	500 x 1635 x 1800
MPA51718V5PKG	500 x 1735 x 1800

MPA6618V5PKG	600 x 635 x 1800 mm
MPA6718V5PKG	600 x 735 x 1800
MPA6818V5PKG	600 x 835 x 1800
MPA6918V5PKG	600 x 935 x 1800
MPA61018V5PKG	600 x 1035 x 1800
MPA61118V5PKG	600 x 1135 x 1800
MPA61218V5PKG	600 x 1235 x 1800
MPA61318V5PKG	600 x 1335 x 1800
MPA61418V5PKG	600 x 1435 x 1800
MPA61518V5PKG	600 x 1535 x 1800
MPA61618V5PKG	600 x 1635 x 1800
MPA61718V5PKG	600 x 1735 x 1800

PREMIUM
SERIES

1790
mm
HEIGHT

V4PKG

4-SHELF MOBILE UNITS

Mobile starter units include 2 mobile post kits, 4 shelf kits vented or solid and 4 swivel casters with total locking brake. Units ship complete in 6 boxes.

Vented

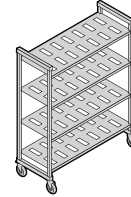

400 mm
DEPTH

DIMENSIONS D x L x H
400 x 980 x 1790 mm
400 x 1080 x 1790
400 x 1180 x 1790
400 x 1280 x 1790
400 x 1380 x 1790

CODE
MPMU4917V4PKG
MPMU41017V4PKG
MPMU41117V4PKG
MPMU41217V4PKG
MPMU41317V4PKG

Solid

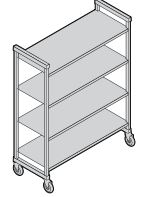

CODE
MPMU4917S4PKG
MPMU41017S4PKG
MPMU41117S4PKG
MPMU41217S4PKG
MPMU41317S4PKG

500 mm
DEPTH

500 x 980 x 1790 mm
500 x 1080 x 1790
500 x 1180 x 1790
500 x 1280 x 1790
500 x 1380 x 1790

MPMU5917V4PKG
MPMU51017V4PKG
MPMU51117V4PKG
MPMU51217V4PKG
MPMU51317V4PKG

MPMU5917S4PKG
MPMU51017S4PKG
MPMU51117S4PKG
MPMU51217S4PKG
MPMU51317S4PKG

600 mm
DEPTH

600 x 980 x 1790 mm
600 x 1080 x 1790
600 x 1180 x 1790
600 x 1280 x 1790
600 x 1380 x 1790

MPMU6917V4PKG
MPMU61017V4PKG
MPMU61117V4PKG
MPMU61217V4PKG
MPMU61317V4PKG

MPMU6917S4PKG
MPMU61017S4PKG
MPMU61117S4PKG
MPMU61217S4PKG
MPMU61317S4PKG

Color: Speckled White (490).

STOCK PRODUCTS & COLORS AVAILABLE IN OUR EUROPEAN WAREHOUSE

ALL SIZES: (490)

*Includes 127 mm casters.



CAMSHELVING® PREMIUM SERIES ACCESSORIES

Bottom Shelf Dunnage Stands

Increase weight bearing capacity on bottom shelf only. Add to any shelf length. Highly recommended for starter units 1380 mm and longer and all corner units, intermediate units and units specified for heavier load volume on and off bottom shelves.

STOCK PRODUCTS & COLORS AVAILABLE IN OUR EUROPEAN WAREHOUSE

ALL SIZES: (490)

CODE	DIMENSIONS D x H
Dunnage Stand – Low	
MPDS30H16	300 x 190 mm
MPDS40H16	400 x 190
MPDS50H16	500 x 190
MPDS60H16	600 x 190
Dunnage Stand – Tall	
MPDS30H30	300 x 289
MPDS40H30	400 x 289
MPDS50H30	500 x 289
MPDS60H30	600 x 289

Case Pack: 1
Color: Speckled White (490).

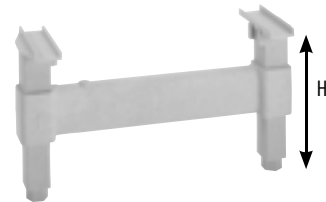

Corner Connectors

Unique patented design ensures maximum shelf space utilization. Use 1 set per shelf to connect starter and add-on units in corners. Connect 4 or 5 intermediate shelves between 2 starter units (2 sets required per shelf). Available as a single set or 8 or 10 set packs.

STOCK PRODUCTS & COLORS AVAILABLE IN OUR EUROPEAN WAREHOUSE

ALL SIZES: (490)

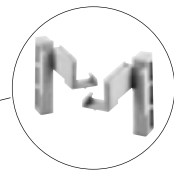

CODE	DESCRIPTION
MPCC1	1 Set for 1 shelf
MPCC8	8 Sets for 4 shelves
MPCC10	10 Sets for 5 shelves

Color: Speckled White (490).

Identification Tags

Clip onto shelf traverses to clearly identify stored product. Made of highly durable plastic with a clear slide in front panel. Labels included.

CODE	DESCRIPTION	DIMENSION L x H
CSID6	152 mm ID Tag	152 x 25 mm
CSID3	76 mm ID Tag	76 x 25

Case Pack: 12 Color: White / Clear.

STOCK PRODUCTS & COLORS AVAILABLE IN OUR EUROPEAN WAREHOUSE

CSID6: (000)



Wall Fastener

Use to secure stationary shelving unit to a wall for added safety and stability where required. Made of stainless steel. Screws not included.

CODE	DIMENSION D x L x H
CSWF	73 x 238 x 48 mm

Case Pack: 4 Color: Silver (000).

STOCK PRODUCTS & COLORS AVAILABLE IN OUR EUROPEAN WAREHOUSE

CSWF: (000)



Hole diameter 1,11 cm



CAMSHELVING® PREMIUM SERIES ACCESSORIES

Seismic Foot

Secure stationary unit posts directly to the floor for added safety and stability where required. Made of stainless steel. Bolts not included.

CODE	DIMENSION D x L x H
CSEQ3	102 x 83 x 59 mm
Case Pack: 4 Color: Silver (000).	



Hole diameter 1,43 cm



Premium Caster

Ideal in all areas of storage, especially coolers, freezers and/or wet areas. Made of highly durable, non-corrosive plastic with a 127 mm swivel, non-marking thermoplastic rubber wheel. Total locking brake locks both swivel motion and the wheel.

CODE	SIZE
MPMCWB	127 mm
Case Pack: 2 Color: Grey (000).	



STOCK PRODUCTS & COLORS AVAILABLE IN OUR EUROPEAN WAREHOUSE

MPMCWB: (000)

Shelf Divider (for 600 mm deep shelf only)

Stack and separate items stored on shelves. Made of highly durable ABS plastic. Installs directly onto solid or vented shelves. Easily removable for relocating or washing. Use with Shelf Rails to prevent contents from falling off shelves.

CODE	DIMENSION D x H
CSSD248	610 x 203 mm
Case Pack: 1 Color: Soft Grey (151).	



STOCK PRODUCTS & COLORS AVAILABLE IN OUR EUROPEAN WAREHOUSE

CSSD248: (151)

Shelf Divider Bars (for 600 mm deep shelf only)

Create a custom service or storage station for food pans, boxes or dish racks. Install straight or angled dividers directly onto shelf traverses.

CODE	DESCRIPTION
CSDBA	Angled Divider Bar
CSDBS	Straight Divider Bar

Case Pack: 4
Color: Speckled Grey (480).



CAMSHELVING® PREMIUM SERIES ACCESSORIES

Shelf Rails

Brackets are quick and easy to install and remove. Fits shelving units 680 to 1780 mm wide and 300 to 600 mm deep. Double rods provide maximum security for shelf contents. New rails can be used with shelf dividers and drying racks. Available in kits of 3 or 4 sides to meet all foodservice needs.

Full Shelf Rail Kits

CODE	DIMENSION D x L
Full Shelf Rail Kits (2 sides, 2 ends)	
MPR600900	600 x 900 mm
MPR6001000	600 x 1000
MPR6001100	600 x 1100
3/4 Shelf Rail Kits (1 side, 2 ends)	
MPR6009003	600 x 900
MPR60010003	600 x 1000
MPR60011003	600 x 1100
Case Pack: 1 Color: Soft Gray (151).	

Shelf Rail kits are available in all depths and all lengths. To see the entire selection of Full & 3/4 kits, see the Camshelving Product Specification and Price List.

Single Side Rail Kits

CODE	LENGTH
MPR600S	600 mm
MPR700S	700
MPR800S	800
MPR900S	900
MPR1000S	1000
MPR1100S	1100
MPR1200S	1200
MPR1300S	1300
MPR1400S	1400
MPR1500S	1500
MPR1600S	1600
MPR1700S	1700

Single End Rail Kits

CODE	DEPTH
MPR300E	300 mm
MPR400E	400
MPR500E	500
MPR600E	600

STOCK PRODUCTS & COLORS AVAILABLE IN OUR EUROPEAN WAREHOUSE

ALL SHELF RAIL KITS: (151)



Single Shelf Sheet Pan / Tray Rack (for 600 mm deep shelf only)

Holds up to 6 each full size (1826) 46 x 66 cm or 12 half size (1318) 32 x 45 cm sheet pans or trays. Install 1 or more units onto vented shelves, any length. High quality, lightweight aluminum material is

safe for use in coolers and freezers. Made from aluminum 6463 (6000 series).

CODE	DIMENSION D x L x H
CSTSR	584 x 517 x 508 mm
Case Pack: 1 Color: Silver (000).	

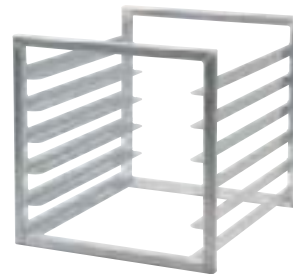

Full-Wrap Security Cage (for 610 mm deep shelf only)

Store valuable products behind locked doors. Made of heavy-duty 304 stainless steel for use in any environment. Stationary or mobile units ship complete with factory assembled post kits, 2 vented shelves, 4 premium swivel casters with total locking brake for mobile unit and 1 full wrap security cage. Bottom shelf must be vented only. Assembly required. Lock not included.

Security cage only, shelving frame not included.

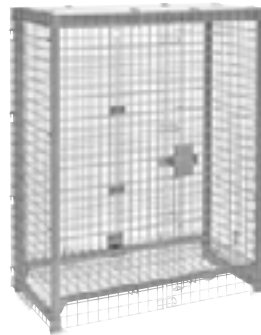

Ships standard with 2 Vented Shelf Kits



CODE	CPFWSC244860	CPU244864SUPKG	CPMU244867SUPKG
DESCRIPTION	Full-wrap security cage only	Full-wrap stationary security unit	Full-wrap mobile security unit
DIMENSION D x L x H	680 x 1276 x 1562 mm	680 x 1276 x 1638 mm	680 x 1276 x 1721 mm
COLOR	Silver (000)	Speckled Grey (480)	Speckled Grey (480)

Case Pack: 1
Fit only Camshelving Premium Series made in the USA.
Special Order. Allow 10 to 12 weeks for delivery for International delivery.

Cage only ships in



Units ship in



CAMSHELVING® PREMIUM SERIES ACCESSORIES

Single Shelf Security Cage (for 600 mm deep shelf only)

Securely store valuable products on a single shelf. Made of heavy duty, 304 stainless steel for use in any environment. Requires 457 mm height between shelves. Install on vented shelves only. Lock not included.

CODE	DIMENSION D x L x H
CSSC244818	640 x 1080 x 460 mm
Case Pack: 1	Color: Silver (000).



Shelf Traverses

Available in single or double packs. Use a single set to add an open shelf for divider bars or drying racks. Add single traverses onto back posts for extra support when placing rolling equipment under the first shelf.

LENGTH	SINGLE PACK CODE*	DOUBLE PACK CODE**
600 mm	MPTR60	—
700	MPTR70	—
800	MPTR80	—
900	MPTR90	MPTR902PK
1000	MPTR100	MPTR1002PK
1100	MPTR110	MPTR1102PK
1200	MPTR120	MPTR1202PK
1300	MPTR130	MPTR1302PK
1400	MPTR140	—
1500	MPTR150	—
1600	MPTR160	—
1700	MPTR170	—

*Case Pack: 1 **Case Pack: 2
Color: Speckled White (490).



**STOCK PRODUCTS & COLORS
AVAILABLE IN OUR EUROPEAN
WAREHOUSE**

ALL SIZES: (490)

Vertical Drying and Storage Cradle (for 600 mm deep shelf only)

Modular 7-slot rack designed for drying and storing trays, sheet pans, cutting boards and lids. Installs directly onto shelf traverses. Use with Shelf Rails to prevent contents from sliding off. Made of highly durable ABS plastic. Available in single or 3 pack.

CODE	DIMENSIONS D x L x H	CASE PACK
CSDR7	597 x 260 x 95 mm	1
CSDR73	597 x 260 x 95	3

Color: Soft Grey (151).

**STOCK PRODUCTS & COLORS
AVAILABLE IN OUR EUROPEAN
WAREHOUSE**

CSDR7, CSDR73: (151)



Vertical Drying and Storage Rack

Promotes sanitary drying, safe handling and efficient product organization with easy access to product. Use with Shelf Rails to prevent contents from sliding off.

Units ship complete with 2 mobile post kits, 6 traverses, 12 or 15 vertical drying cradles and premium swivel casters with total locking brake. Assembly required.

CODE	DIMENSIONS D x L x H	HOLDING CAPACITY
MPMU61117DRPKG	600 x 1180 x 1790 mm	84 trays
MPMU61317DRPKG	600 x 1380 x 1790	105 trays

Color: Speckled White (490).

**STOCK PRODUCTS & COLORS
AVAILABLE IN OUR EUROPEAN
WAREHOUSE**

MPMU61117DRPKG, MPMU61317DRPKG: (490)

1180 mm long
unit ships in

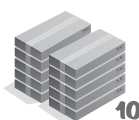

1380 mm long
unit ships in

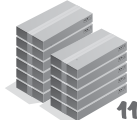

CAMSHELVING® PREMIUM SERIES ACCESSORIES

Dome Drying and Storage Cradle (for 540 mm deep shelf only)

Use to dry and safely store up to 10 patient meal delivery domes or plate covers upright. Installs directly onto shelf traverses. Made of highly durable ABS plastic. Available in single or 5 pack.

CODE	DIMENSIONS D x L x H	CASE PACK
CSDDC	520 x 415 x 86 mm	1
CSDDC5	520 x 415 x 86	5

Color: Soft Grey (151).
Fits only Camshelving Premium Series made in the USA. Special Order. Allow 10 to 12 weeks for delivery for International delivery.



Dome Drying and Storage Rack

Promotes sanitary drying, safe handling and efficient product organization with easy access to product.

Unit ships complete with factory assembled mobile post kits, 10 traverses, 10 dome drying cradles and premium swivel casters with total locking brake. Assembly required.

CODE	DIMENSIONS D x L x H	HOLDING CAPACITY
CPMU213675DDPKG	540 x 910 x 1910 mm	100 domes

Color: Speckled Grey (480).
Camshelving Premium Series unit made in the USA. Special Order. Allow 10 to 12 weeks for delivery for International delivery.



Angled Drying and Storage Cradle (for 600 mm deep shelf only)

Uniquely designed cradle holds up to 8 each meal delivery pellets or use to dry, store and transport food pans and other commercial kitchen ware. Installs directly onto shelf traverses. Made of highly durable ABS plastic. Available in single or 4 pack.

CODE	DIMENSIONS D x L x H	CASE PACK
CSDR8	592 x 263 x 160 mm	1
CSDR84	592 x 263 x 160	4

Color: Soft Grey (151).

STOCK PRODUCTS & COLORS AVAILABLE IN OUR EUROPEAN WAREHOUSE

CSDR8, CSDR84: (151)



Angled Drying and Storage Rack

Promotes sanitary drying, safe handling and efficient product organization with easy access to product.

Units ship complete with 2 mobile post kits, 8 traverses, 16 angled drying cradles and premium swivel casters with total locking brake. Assembly required.

CODE	DIMENSIONS D x L x H	HOLDING CAPACITY
MPMU61217PDPKG	600 x 1280 x 1790 mm	128 Pellets and Bases or 16 GN 1/1 Food Pans

Color: Speckled White (490).

STOCK PRODUCTS & COLORS AVAILABLE IN OUR EUROPEAN WAREHOUSE

MPMU61217PDPKG: (490)

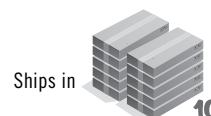



SANPELLEGRINO

SANPELLEGRINO

ALLEGROLI ALLEGROLI

CAMSHELVING® PREMIUM SERIES

High Density Storage Floor Track System

Maximize storage capacity by creating storage aisles in all available space. This simple system is composed of stationary starter units anchored to a raised floor track system at both ends with high density mobile units installed in between. Easy to install track requires no drilling or gluing.



High Density Mobile Units are available with factory assembled post kits, vented or solid shelves and high density casters and bumpers. Full track and extension kits ship complete with required hardware. Stationary Starter Units are required to anchor the system at both ends. Choose from a wide selection (see pages 102-103).

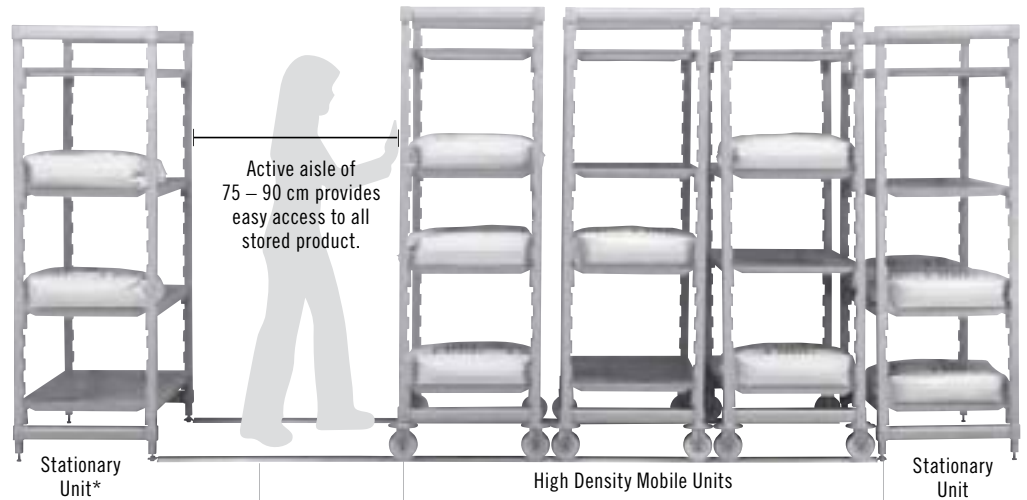

Only available from Cambro European Logistics (CEL), Germany and Cambro Özay Turkey.

Raised Floor Track provides a smooth and level surface to easily roll mobile units. Raised track ensures dirt will not get trapped and is easy to clean. Aluminum track and stainless steel hardware are rust resistant.



Grooved casters roll easily and securely on raised track.



Raised track connects easily to the bottom of a stationary unit that works as a system anchor. No bolts, no glue or drilling into the floor are required. Easy and fast set up.

*It is recommended to use a stationary unit for every 4,5 m of track to further stabilize the system.

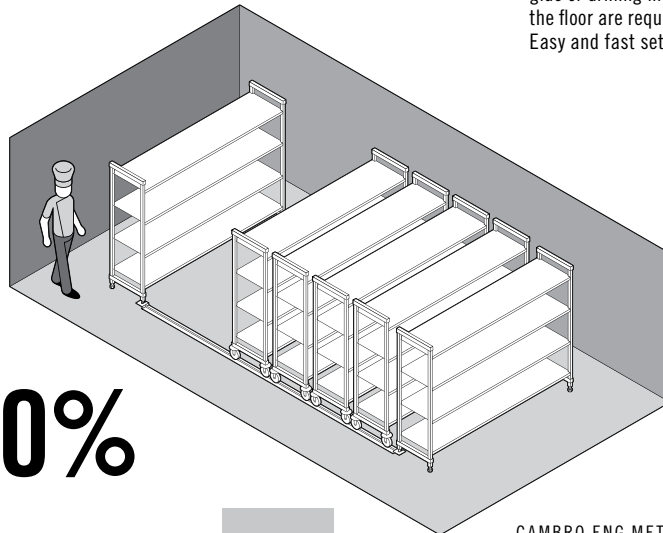
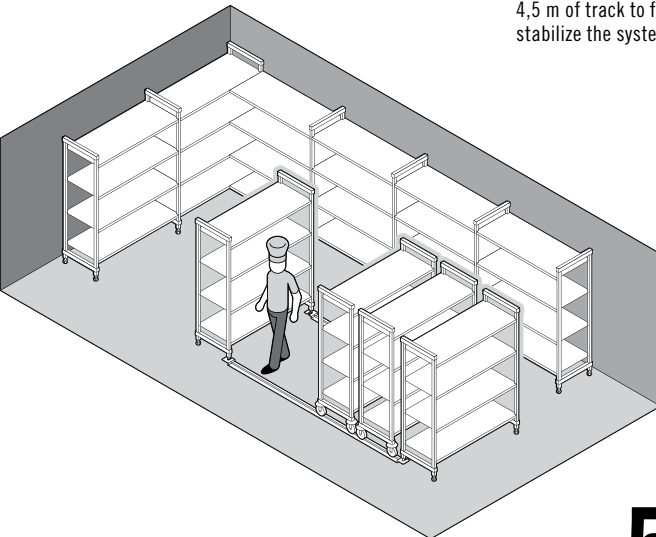

Increases Storage Capacity Up To **50%**

4-Shelf Vented High Density Mobile Starter Units

Units include 2 mobile post kits, 4 shelf kits, 4 high density casters and 4 high density bumpers.

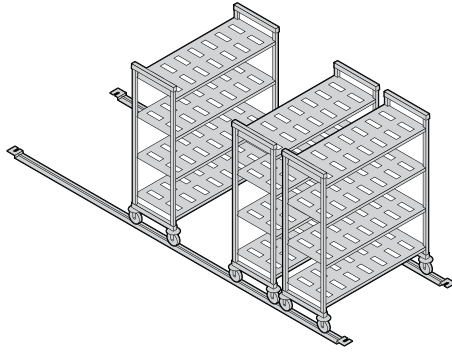

HEIGHT*	DEPTHS	LENGTHS
1	2	5
1790 mm	500 mm 600	980 mm 1080 1180 1280 1380

* Includes 127 mm casters.

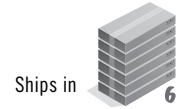

4-Shelf Solid High Density Mobile Starter Units

Units include 2 mobile post kits, 4 shelf kits, 4 high density casters and 4 high density bumpers.

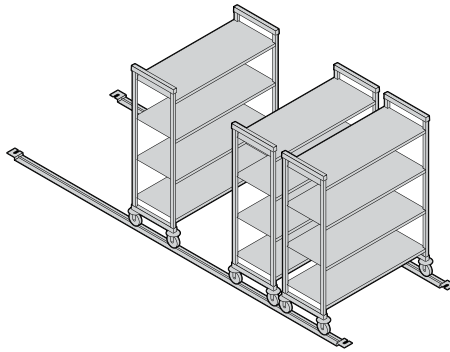

HEIGHT*	DEPTHS	LENGTHS
1	2	5
1790 mm	500 mm 600	980 mm 1080 1180 1280 1380

*Includes 127 mm casters.

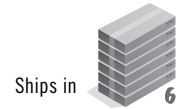

Full Track and Extension Kits

Aluminum raised track kits and track extensions ship complete in 1 box. Each kit includes all stainless steel hardware necessary to complete a floor installation.

It is highly recommended to install a stationary starter unit every 4,5 m of track to further stabilize the system.



Full Track LENGTHS	Track Extension LENGTHS
3	3
3,05 m	1,38 m
3,66	1,53
4,42	1,83



CODE	DESCRIPTION	CASE PACK
Full Track Kit		
CSMHDTK10	3,05 m Track for 3 Mobile Units*	1
CSMHDTK12	3,66 m Track for 4 Mobile Units*	1
CSMHDTK145	4,42 m Track for 5 Mobile Units*	1
Track Extension Kit		
CSMHDTKE4	1,38 m Track Extension	1
CSMHDTKE5	1,53 m Track Extension	1
CSMHDTKE6	1,83 m Track Extension	1
Accessories		
CSHDF	Floor Fastener	4

Color: Silver (000). *Based on 600 mm deep mobile units.

STOCK PRODUCTS & COLORS AVAILABLE IN OUR EUROPEAN WAREHOUSE

ALL FLOOR TRACK KIT AND EXTENSION SIZES: (000)

V4

4-SHELF VENTED HIGH DENSITY MOBILE UNITS

S4

4-SHELF SOLID HIGH DENSITY MOBILE UNITS

Units include 2 mobile post kits, 4 shelf kits, 4 high density casters and 4 high density bumpers. Units ship complete in 6 boxes.

1790
mm
HEIGHT

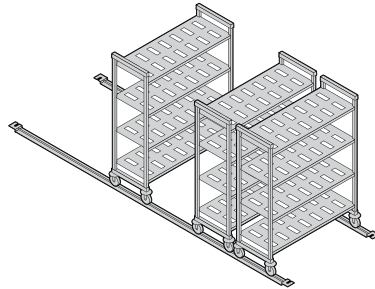

500 mm
DEPTH

CODE	DIMENSIONS D x L x H*
MPHU5917V4PKG	500 x 980 x 1790 mm
MPHU51017V4PKG	500 x 1080 x 1790
MPHU51117V4PKG	500 x 1180 x 1790
MPHU51217V4PKG	500 x 1280 x 1790
MPHU51317V4PKG	500 x 1380 x 1790

600 mm
DEPTH

MPHU6917V4PKG	600 x 980 x 1790 mm
MPHU61017V4PKG	600 x 1080 x 1790
MPHU61117V4PKG	600 x 1180 x 1790
MPHU61217V4PKG	600 x 1280 x 1790
MPHU61317V4PKG	600 x 1380 x 1790

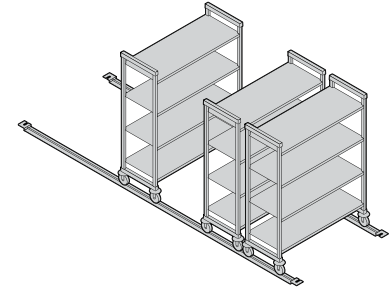

CODE	DIMENSIONS D x L x H*
MPHU5917S4PKG	500 x 980 x 1790 mm
MPHU51017S4PKG	500 x 1080 x 1790
MPHU51117S4PKG	500 x 1180 x 1790
MPHU51217S4PKG	500 x 1280 x 1790
MPHU51317S4PKG	500 x 1380 x 1790

MPHU6917S4PKG	600 x 980 x 1790 mm
MPHU61017S4PKG	600 x 1080 x 1790
MPHU61117S4PKG	600 x 1180 x 1790
MPHU61217S4PKG	600 x 1280 x 1790
MPHU61317S4PKG	600 x 1380 x 1790

Color: Speckled White (490). *Includes 127 mm casters.

STOCK PRODUCTS & COLORS AVAILABLE IN OUR EUROPEAN WAREHOUSE

ALL SIZES: (490)

High Density Caster with Donut Bumper

Grooved caster rolls easily and securely on raised track. Donut bumper protects mobile units from coming into direct contact with each other.

CODE	SIZE
MPMCHD	127 mm

Case Pack: 2 Color: Grey (000).



STOCK PRODUCTS & COLORS AVAILABLE IN OUR EUROPEAN WAREHOUSE

MPMCHD: (000)

CAMSHELVING® ELEMENTS series

WHY CHOOSE ELEMENTS?

Made from a revolutionary, extremely strong composite material with a smooth, easy to clean surface. Elements Series is stronger than common wire shelving. It's lighter in weight than Camshelving Premium Series and totally impervious to moisture, chemicals and liquids that can destroy shelving over time. Elements Series is designed for medium to heavy storage use in freezers, coolers, dry storage or warewashing areas. It easily supports the performance demands of a busy foodservice operation.



All Environments
-38°C TO 88°C

Stationary

Mobile

camguard
ANTIMICROBIAL SHELF PLATES



Post Connectors, Corner Connectors, Seismic Foot, Wall Fastener, Identification Tags, Single Shelf Security Cage, Tray Slide Rack, and Shelf Divider Bars are not NSF Listed.

storage needs

MEDIUM to HEAVY

weekly deliveries

5 – 7

CAMSHELVING® ELEMENTS SERIES
STATIONARY UNIT SIZES

MOBILE UNIT SIZES

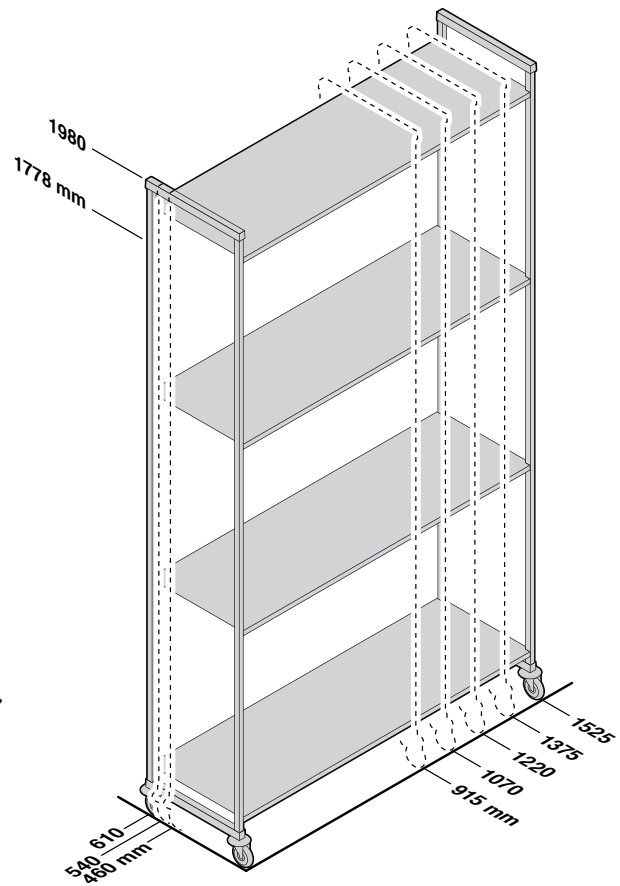
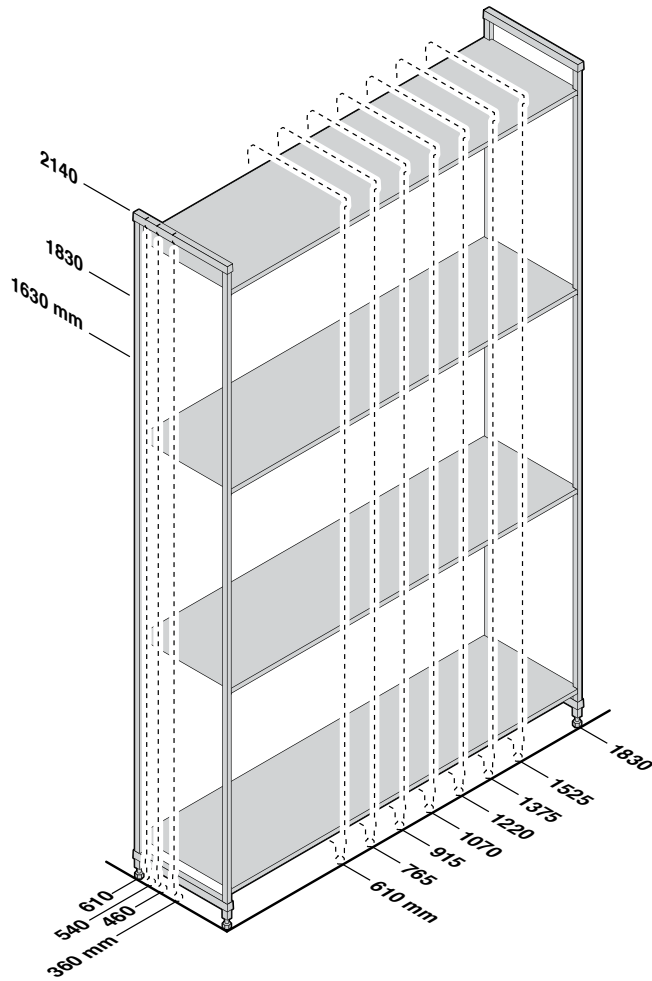

ELEMENTS SERIES WEIGHT BEARING CAPACITY

Weight must be evenly distributed across the entire shelf.

		UNIT LENGTH 610 – 1220 MM	UNIT LENGTH 1375 – 1830 MM
SINGLE UNIT	Unit only	910 kg	910 kg
	Shelf only	365	275
	Unit with dunnage stand*	1110	1045
	Bottom shelf with dunnage stand*	545	410
CORNER UNIT with 2 dunnage stands required	Unit only	820	—
	Shelf only	185	—
	Bottom shelf with dunnage stands*	275	—
MOBILE UNIT	Unit only**	340	—

**Due to the weight bearing capacity of casters, maximum weight load on an entire Mobile Unit is 340 kg.

*Dunnage Stands add stability and increase weight bearing capacity on bottom shelf only. Highly recommended for Starter Units 1375 mm and longer, all Corner Units, U-Shape Units and units specified for heavier loads. (See page 96).

CAMSHELVING® ELEMENTS SERIES

Starter, Add-On and Mobile Units

These units make ordering easy and save time and labor during installation. Units ship complete in one box. Post kits are pre-assembled at the factory, speeding up on site set up.



4-Shelf Vented Stationary Starter and Add-On Units

Starter units include 2 factory assembled post kits and shelves.
Add-On units include 1 factory assembled post kit and shelves.

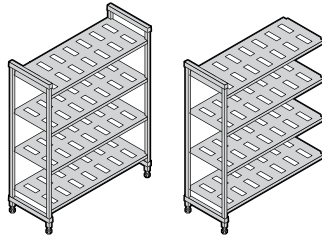

HEIGHTS	DEPTHS	LENGTHS	
3	3	8	
1630 mm	460 mm	610 mm	1220 mm
1830	540	765	1375
2140	610	915	1525
		1070	1830

Ships in  1

4-Shelf Solid Stationary Starter and Add-On Units

Starter units include 2 factory assembled post kits and shelves.
Add-On units include 1 factory assembled post kit and shelves.

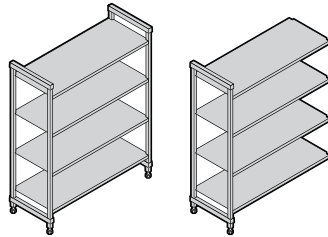

HEIGHTS	DEPTHS	LENGTHS	
3	3	8	
1630 mm	460 mm	610 mm	1220 mm
1830	540	765	1375
2140	610	915	1525
		1070	1830

Ships in  1

4-Shelf Vented and Solid Stationary Starter and Add-On Units (3 vented + 1 solid)

Starter units include 2 factory assembled post kits and shelves.
Add-On units include 1 factory assembled post kit and shelves.
Install solid shelf on bottom to prevent water/cleaning solutions from sloshing up onto stored products. Install solid shelf on top to protect product stored on lower shelves from condensation in cooler.

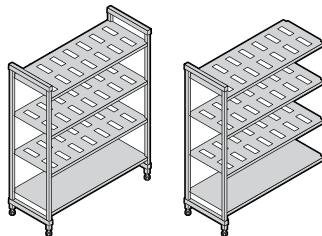

HEIGHTS	DEPTHS	LENGTHS	
3	3	8	
1630 mm	460 mm	610 mm	1220 mm
1830	540	765	1375
2140	610	915	1525
		1070	1830

Ships in  1

5-Shelf Vented Stationary Starter and Add-On Units

Starter units include 2 factory assembled post kits and shelves.

Add-On units include 1 factory assembled post kit and shelves.

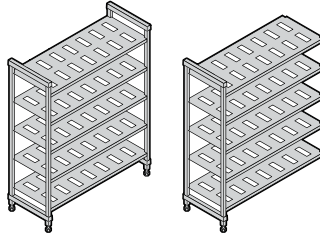

HEIGHTS	DEPTHS	LENGTHS	
3	3	8	
1630 mm	460 mm	610 mm	1220 mm
1830	540	765	1375
2140	610	915	1525
		1070	1830

Ships in  4

5-Shelf Solid Stationary Starter and Add-On Units

Starter units include 2 factory assembled post kits and shelves.

Add-On units include 1 factory assembled post kit and shelves.

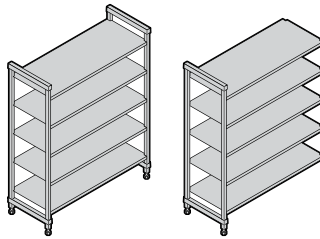

HEIGHT	DEPTHS	LENGTHS	
1	3	8	
2140 mm	460 mm	610 mm	1220 mm
	540	765	1375
	610	915	1525
		1070	1830

Ships in  4

5-Shelf Vented and Solid Stationary Starter And Add-On Units (4 vented + 1 solid)

Starter units include 2 factory assembled post kits and shelves.

Add-On units include 1 factory assembled post kit and shelves.

Install solid shelf on bottom to prevent water/cleaning solutions from sloshing up onto stored products.

Install solid shelf on top to protect product stored on lower shelves from condensation in cooler.

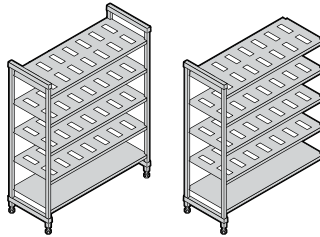

HEIGHT	DEPTHS	LENGTHS	
1	3	8	
2140 mm	460 mm	610 mm	1220 mm
	540	765	1375
	610	915	1525
		1070	1830

Ships in  4

4 or 5-Shelf Vented Mobile Starter Units

Mobile starter units include 2 factory assembled mobile post kits, shelves and 4 premium swivel casters with total locking brake.

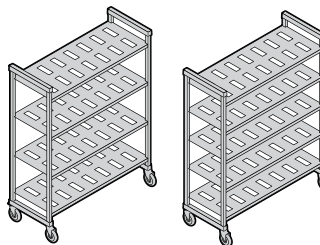

HEIGHTS*	DEPTHS	LENGTHS	
2	3	5	
1778 mm	460 mm	915 mm	1375 mm
1980	540	1070	1525
	610	1220	

*Includes 127 mm casters.

Ships in  4



Visit the Camshelving website at www.cambro.com/camshelving for product information, assembly videos and design layouts, or to view or download the Camshelving Specification and Price List.

ELEMENTS
SERIES

V4

4-SHELF VENTED UNITS

1630
mm
HEIGHT

Starter units include 2 factory assembled stationary post kits, stationary traverses, stationary traverse dovetails and shelf plates. Add-On units include 1 factory assembled stationary post kit, stationary traverses, stationary traverse dovetails and shelf plates. Units ship complete in 1 box.

Starter

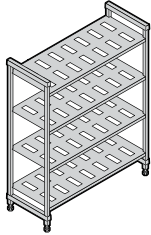

Add-On

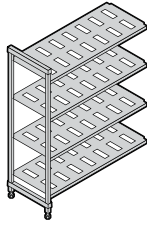

460 mm
DEPTH

DIMENSIONS
D x L x H

460 x 610 x 1630 mm
460 x 765 x 1630
460 x 915 x 1630
460 x 1070 x 1630
460 x 1220 x 1630
460 x 1375 x 1630
460 x 1525 x 1630
460 x 1830 x 1630

CODE

ESU182464V4
ESU183064V4
ESU183664V4
ESU184264V4
ESU184864V4
ESU185464V4
ESU186064V4
ESU187264V4

CODE

EA182464V4
EA183064V4
EA183664V4
EA184264V4
EA184864V4
EA185464V4
EA186064V4
EA187264V4

540 mm
DEPTH

540 x 610 x 1630 mm
540 x 765 x 1630
540 x 915 x 1630
540 x 1070 x 1630
540 x 1220 x 1630
540 x 1375 x 1630
540 x 1525 x 1630
540 x 1830 x 1630

ESU212464V4
ESU213064V4
ESU213664V4
ESU214264V4
ESU214864V4
ESU215464V4
ESU216064V4
ESU217264V4

EA212464V4
EA213064V4
EA213664V4
EA214264V4
EA214864V4
EA215464V4
EA216064V4
EA217264V4

610 mm
DEPTH

610 x 610 x 1630 mm
610 x 765 x 1630
610 x 915 x 1630
610 x 1070 x 1630
610 x 1220 x 1630
610 x 1375 x 1630
610 x 1525 x 1630
610 x 1830 x 1630

ESU242464V4
ESU243064V4
ESU243664V4
ESU244264V4
ESU244864V4
ESU245464V4
ESU246064V4
ESU247264V4

EA242464V4
EA243064V4
EA243664V4
EA244264V4
EA244864V4
EA245464V4
EA246064V4
EA247264V4

ELEMENTS
SERIES

V4

4-SHELF VENTED UNITS

1830
mm
HEIGHT

Starter units include 2 factory assembled stationary post kits, stationary traverses, stationary traverse dovetails and shelf plates. Add-On units include 1 factory assembled stationary post kit, stationary traverses, stationary traverse dovetails and shelf plates. Units ship complete in 1 box.

Starter

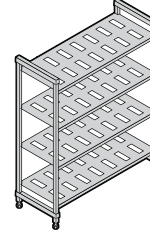

Add-On

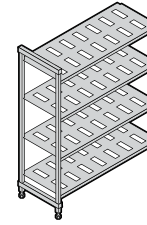

DIMENSIONS
D x L x H

460 x 610 x 1830 mm
460 x 765 x 1830
460 x 915 x 1830
460 x 1070 x 1830
460 x 1220 x 1830
460 x 1375 x 1830
460 x 1525 x 1830
460 x 1830 x 1830

CODE

ESU182472V4
ESU183072V4
ESU183672V4
ESU184272V4
ESU184872V4
ESU185472V4
ESU186072V4
ESU187272V4

CODE

EA182472V4
EA183072V4
EA183672V4
EA184272V4
EA184872V4
EA185472V4
EA186072V4
EA187272V4

540 x 610 x 1830 mm
540 x 765 x 1830
540 x 915 x 1830
540 x 1070 x 1830
540 x 1220 x 1830
540 x 1375 x 1830
540 x 1525 x 1830
540 x 1830 x 1830

ESU212472V4
ESU213072V4
ESU213672V4
ESU214272V4
ESU214872V4
ESU215472V4
ESU216072V4
ESU217272V4

EA212472V4
EA213072V4
EA213672V4
EA214272V4
EA214872V4
EA215472V4
EA216072V4
EA217272V4

610 x 610 x 1830 mm
610 x 765 x 1830
610 x 915 x 1830
610 x 1070 x 1830
610 x 1220 x 1830
610 x 1375 x 1830
610 x 1525 x 1830
610 x 1830 x 1830

ESU242472V4
ESU243072V4
ESU243672V4
ESU244272V4
ESU244872V4
ESU245472V4
ESU246072V4
ESU247272V4

EA242472V4
EA243072V4
EA243672V4
EA244272V4
EA244872V4
EA245472V4
EA246072V4
EA247272V4

Color: Brushed Graphite (580).

ELEMENTS
SERIES

V5

5-SHELF VENTED UNITS

2140
mm
HEIGHT

Starter units include 2 factory assembled stationary post kits, stationary traverses, stationary traverse dovetails and shelf plates. Add-On units include 1 factory assembled stationary post kit, stationary traverses, stationary traverse dovetails and shelf plates. Units ship complete in 1 box.

Starter

Add-On

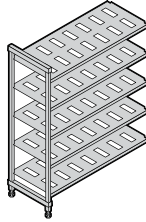
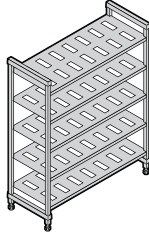

460 mm
DEPTH

DIMENSIONS
D x L x H

460 x 610 x 2140 mm
460 x 765 x 2140
460 x 915 x 2140
460 x 1070 x 2140
460 x 1220 x 2140
460 x 1375 x 2140
460 x 1525 x 2140
460 x 1830 x 2140

CODE

ESU182484V5
ESU183084V5
ESU183684V5
ESU184284V5
ESU184884V5
ESU185484V5
ESU186084V5
ESU187284V5

CODE

EA182484V5
EA183084V5
EA183684V5
EA184284V5
EA184884V5
EA185484V5
EA186084V5
EA187284V5

540 mm
DEPTH

540 x 610 x 2140 mm
540 x 765 x 2140
540 x 915 x 2140
540 x 1070 x 2140
540 x 1220 x 2140
540 x 1375 x 2140
540 x 1525 x 2140
540 x 1830 x 2140

ESU212484V5
ESU213084V5
ESU213684V5
ESU214284V5
ESU214884V5
ESU215484V5
ESU216084V5
ESU217284V5

EA212484V5
EA213084V5
EA213684V5
EA214284V5
EA214884V5
EA215484V5
EA216084V5
EA217284V5

610 mm
DEPTH

610 x 610 x 2140 mm
610 x 765 x 2140
610 x 915 x 2140
610 x 1070 x 2140
610 x 1220 x 2140
610 x 1375 x 2140
610 x 1525 x 2140
610 x 1830 x 2140

ESU242484V5
ESU243084V5
ESU243684V5
ESU244284V5
ESU244884V5
ESU245484V5
ESU246084V5
ESU247284V5

EA242484V5
EA243084V5
EA243684V5
EA244284V5
EA244884V5
EA245484V5
EA246084V5
EA247284V5

Color: Brushed Graphite (580).

ELEMENTS
SERIES

V4

4-SHELF VENTED MOBILE UNITS

Mobile units include 2 factory assembled mobile post kits, mobile traverses, mobile traverse dovetails, shelf plates, and 4 premium swivel casters with total locking brake. Units ship complete in 1 box.

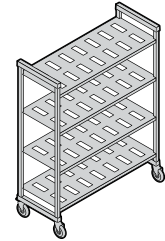

* Includes
127 mm
casters.

1778
mm
HEIGHT

460 mm
DEPTH

540 mm
DEPTH

610 mm
DEPTH

1980
mm
HEIGHT

460 mm
DEPTH

540 mm
DEPTH

610 mm
DEPTH

CODE	DIMENSIONS D x L x H*
EMU183670V4	460 x 915 x 1778 mm
EMU184270V4	460 x 1070 x 1778
EMU184870V4	460 x 1220 x 1778
EMU185470V4	460 x 1375 x 1778
EMU186070V4	460 x 1525 x 1778

EMU213670V4	540 x 915 x 1778 mm
EMU214270V4	540 x 1070 x 1778
EMU214870V4	540 x 1220 x 1778
EMU215470V4	540 x 1375 x 1778
EMU216070V4	540 x 1525 x 1778

EMU243670V4	610 x 915 x 1778 mm
EMU244270V4	610 x 1070 x 1778
EMU244870V4	610 x 1220 x 1778
EMU245470V4	610 x 1375 x 1778
EMU246070V4	610 x 1525 x 1778

CODE	DIMENSIONS D x L x H*
EMU183678V4	460 x 915 x 1980 mm
EMU184278V4	460 x 1070 x 1980
EMU184878V4	460 x 1220 x 1980
EMU185478V4	460 x 1375 x 1980
EMU186078V4	460 x 1525 x 1980

EMU213678V4	540 x 915 x 1980 mm
EMU214278V4	540 x 1070 x 1980
EMU214878V4	540 x 1220 x 1980
EMU215478V4	540 x 1375 x 1980
EMU216078V4	540 x 1525 x 1980

EMU243678V4	610 x 915 x 1980 mm
EMU244278V4	610 x 1070 x 1980
EMU244878V4	610 x 1220 x 1980
EMU245478V4	610 x 1375 x 1980
EMU246078V4	610 x 1525 x 1980



CAMSHELVING® ELEMENTS SERIES ACCESSORIES

Bottom Shelf Dunnage Stands

Increase weight bearing capacity on bottom shelf only. Add to any shelf length. Highly recommended for starter units 1375 mm and longer and all corner units, intermediate units and units specified for heavier load volume on and off bottom shelves.

CODE	DIMENSIONS D x H
Dunnage Stand – Low	
EDS14H6	360 x 165 mm
EDS18H6	460 x 165
EDS21H6	540 x 165
EDS24H6	610 x 165
Dunnage Stand – Tall	
EDS14H10	360 x 267
EDS18H10	460 x 267
EDS21H10	540 x 267
EDS24H10	610 x 267

Case Pack: 1
Color: Brushed Graphite (580).



Corner Connectors

Unique patented design ensures maximum shelf space utilization. Use 1 set per shelf to connect starter and add-on units in corners. Connect 4 or 5 intermediate shelves between 2 starter units (2 sets required per shelf). Available as a single set or 8 or 10 set packs.

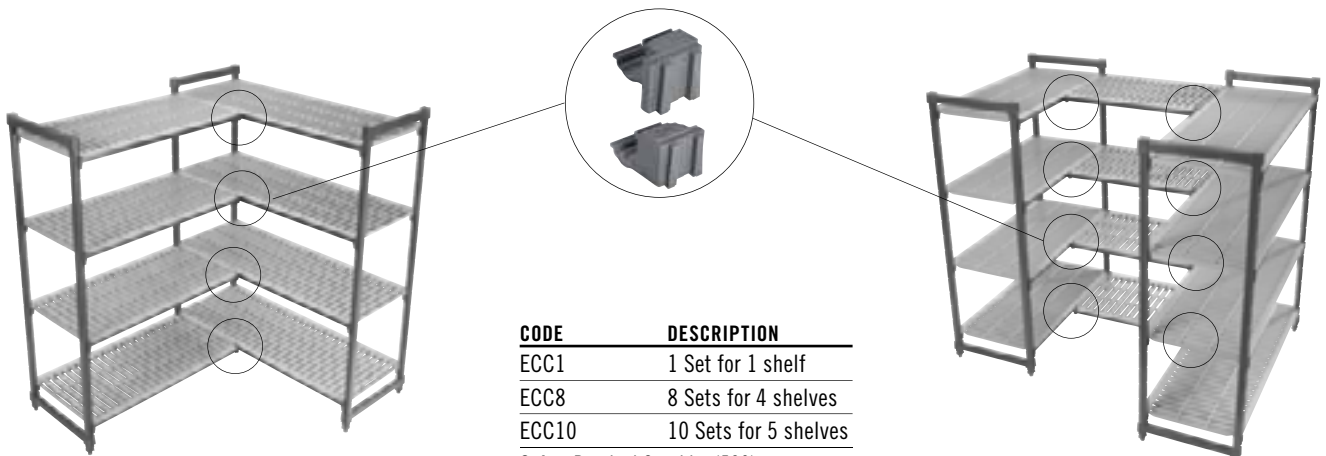

CODE	DESCRIPTION
ECC1	1 Set for 1 shelf
ECC8	8 Sets for 4 shelves
ECC10	10 Sets for 5 shelves

Color: Brushed Graphite (580).

CAMSHELVING® ELEMENTS SERIES ACCESSORIES

Identification Tags

Clip onto shelf traverses to clearly identify stored product. Made of highly durable plastic with a clear slide in front panel. Labels included.

<u>CODE</u>	<u>DESCRIPTION</u>	<u>DIMENSION</u> <u>L x H</u>
CSID6	152 mm ID Tag	152 x 25 mm
CSID3	76 mm ID Tag	76 x 25

Case Pack: 12 **Color:** White / Clear.



STOCK PRODUCTS & COLORS AVAILABLE IN OUR EUROPEAN WAREHOUSE

CSID6: (000)

Wall Fastener

Use to secure stationary shelving unit to a wall for added safety and stability where required. Made of stainless steel. Screws not included.

<u>CODE</u>	<u>DIMENSION</u> <u>D x L x H</u>
CSWF	73 x 238 x 48 mm

Case Pack: 4 **Color:** Silver (000).



Hole diameter 1,11 cm



STOCK PRODUCTS & COLORS AVAILABLE IN OUR EUROPEAN WAREHOUSE

CSWF: (000)

Seismic Foot

Secure stationary unit posts directly to the floor for added safety and stability where required. Made of stainless steel. Bolts not included.

<u>CODE</u>	<u>DIMENSION</u> <u>D x L x H</u>
CSEQ3	102 x 83 x 59 mm

Case Pack: 4 **Color:** Silver (000).



Hole diameter 1,43 cm



Premium Caster

Ideal in all areas of storage, especially coolers, freezers and/or wet areas. Made of highly durable, non-corrosive plastic with a 127 mm swivel, non-marking thermoplastic rubber wheel. Total locking brake locks both swivel motion and the wheel.

<u>CODE</u>	<u>SIZE</u>
EMCWB	127 mm

Case Pack: 2 **Color:** Grey (000).



Donut Bumper

Offers added protection during transport and when maneuvering mobile units into place against walls or alongside other units for storage.

<u>CODE</u>	<u>DIAMETER</u>
CSMHDBB	127 mm

Case Pack: 4 **Color:** Grey (000).



CAMSHELVING® ELEMENTS SERIES ACCESSORIES

Shelf Divider

Stack and separate items stored on shelves. Made of highly durable ABS plastic. Installs directly onto solid or vented shelves. Easily removable for relocating or washing. Use with Shelf Rails to prevent contents from falling off shelves.

CODE	DIMENSION D x H
CSSD188	460 x 203 mm
CSSD218	540 x 203
CSSD248	610 x 203

Case Pack: 1 **Color:** Soft Grey (151).

**STOCK PRODUCTS & COLORS
AVAILABLE IN OUR EUROPEAN
WAREHOUSE**

ALL SIZES: (151)



Shelf Divider Bars (for 610 mm deep shelf only)

Create a custom service or storage station for food pans, boxes or dish racks. Install straight or angled dividers directly onto shelf traverses.

CODE	DESCRIPTION
EDBA	Angled Divider Bar
EDBS	Straight Divider Bar

Case Pack: 4
Color: Speckled Grey (480).



Shelf Rails

Brackets are quick and easy to install and remove. Fits shelving units 610 to 1830 mm wide and 360 to 610 mm deep. Double rods provide maximum security for shelf contents. New rails can be used with shelf dividers and drying racks. Available in kits of 3 or 4 sides to meet all foodservice needs.

Full Shelf Rail Kits

CODE	DIMENSION D x L
Full Shelf Rail Kits (2 sides, 2 ends)	
ESR2436	610 x 910 mm
ESR2442	610 x 1070
ESR2448	610 x 1220
3/4 Shelf Rail Kits (1 side, 2 ends)	
ESR24363	610 x 910
ESR24423	610 x 1070
ESR24483	610 x 1220

Case Pack: 1 **Color:** Soft Gray (151).

Single Side Rail Kits

CODE	LENGTH
ESR24S	610 mm
ESR30S	760
ESR36S	910
ESR42S	1070
ESR48S	1220
ESR54S	1380
ESR60S	1530
ESR72S	1830

Single End Rail Kits

CODE	DEPTH
ESR14E	360 mm
ESR18E	460
ESR21E	540
ESR24E	610

Shelf Rail kits are available in all depths and all lengths. To see the entire selection of Full & 3/4 kits, see the Camshelving Product Specification and Price List.



New!

Single Shelf Sheet Pan / Tray Rack (for 610 mm deep shelf only)

Holds up to 6 each full size (1826) 46 x 66 cm or 12 half size (1318) 32 x 45 cm sheet pans or trays. Install 1 or more units onto vented shelves, any length. High quality, lightweight aluminum material is safe for use in coolers and freezers. Made from aluminum 6463 (6000 series).

CODE	DIMENSION D x L x H
CSTSR	584 x 517 x 508 mm

Case Pack: 1 **Color:** Silver (000).

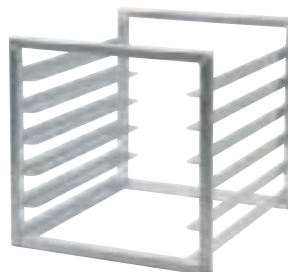

CAMSHELVING® ELEMENTS SERIES ACCESSORIES

Single Shelf Security Cage (for 610 mm deep shelf only)

Securely store valuable products on a single shelf. Made of heavy duty, 304 stainless steel for use in any environment. Requires 457 mm height between shelves. Install on vented shelves only. Lock not included.

CODE	DIMENSION D x L x H
CSSC244818	640 x 1080 x 460 mm
Case Pack: 1	Color: Silver (000).



Shelf Traverses

Available in single or double packs, stationary or mobile. Use two traverses to add an open shelf for divider bars or drying cradles. Add one stationary traverse onto back posts of a stationary unit for extra support when placing rolling equipment under the first shelf. Traverse dovetails included.

Stationary		
LENGTH	SINGLE PACK CODE*	DOUBLE PACK CODE**
610 mm	ETR24	—
765	ETR30	—
915	ETR36	ETR362PK
1070	ETR42	ETR422PK
1220	ETR48	ETR482PK
1375	ETR54	ETR542PK
1525	ETR60	ETR602PK
1830	ETR72	—

*Case Pack: 1 **Case Pack: 2
Color: Brushed Graphite (580).

Mobile		
LENGTH	SINGLE PACK CODE*	DOUBLE PACK CODE**
915 mm	EMTR36	EMTR362PK
1070	EMTR42	EMTR422PK
1220	EMTR48	EMTR482PK
1375	EMTR54	EMTR542PK
1525	EMTR60	EMTR602PK

*Case Pack: 1 **Case Pack: 2
Color: Brushed Graphite (580).

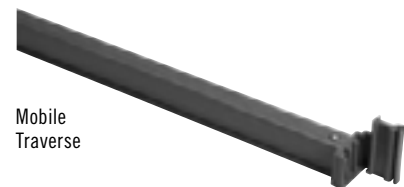

Dome Drying and Storage Cradle (for 540 mm deep shelf only)

Use to dry and safely store up to 10 patient meal delivery domes or plate covers upright. Installs directly onto shelf traverses. Made of highly durable ABS plastic. Available in single or 5 pack.

CODE	DIMENSIONS D x L x H	CASE PACK
CSDDC	520 x 415 x 86 mm	1
CSDDC5	520 x 415 x 86	5
Color: Soft Grey (151).		



CAMSHELVING® ELEMENTS SERIES ACCESSORIES

Vertical Drying and Storage Cradle (for 610 mm deep shelf only)

Modular 7-slot rack designed for drying and storing trays, sheet pans, cutting boards and lids. Installs directly onto shelf traverses. Made of highly durable ABS plastic. Available in single or 3 pack. Use with Shelf Rails to prevent contents from sliding off.

CODE	DIMENSIONS D x L x H	CASE PACK
CSDR7	597 x 260 x 95 mm	1
CSDR73	597 x 260 x 95	3

Color: Soft Grey (151).

**STOCK PRODUCTS & COLORS
AVAILABLE IN OUR EUROPEAN
WAREHOUSE**

CSDR7, CSDR73: (151)



Vertical Drying and Storage Rack

Promotes sanitary drying, safe handling and efficient product organization with easy access to product. Use with Shelf Rails to prevent contents from sliding off.

Units ship complete with factory assembled mobile post kits, 6 mobile shelf traverses, mobile shelf traverse dovetails, 12 or 15 vertical drying cradles and premium swivel casters with total locking brake. Assembly required.

CODE	DIMENSIONS D x L x H	HOLDING CAPACITY
EMU244878DRPKG	610 x 1220 x 1980 mm	84 trays
EMU246078DRPKG	610 x 1530 x 1980	105

Color: Brushed Graphite (580).

1220 mm long unit ships in

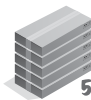

5

1530 mm long unit ships in

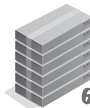

6



Angled Drying and Storage Cradle (for 610 mm deep shelf only)

Uniquely designed cradle holds up to 8 each meal delivery pellets or use to dry, store and transport food pans and other commercial kitchen ware. Installs directly onto shelf traverses. Made of highly durable ABS plastic. Available in single or 4 pack.

CODE	DIMENSIONS D x L x H	CASE PACK
CSDR8	592 x 263 x 160 mm	1
CSDR84	592 x 263 x 160	4

Color: Soft Grey (151).

**STOCK PRODUCTS & COLORS
AVAILABLE IN OUR EUROPEAN
WAREHOUSE**

CSDR8, CSDR84: (151)



Angled Drying and Storage Rack

Promotes sanitary drying, safe handling and efficient product organization with easy access to product.

Unit ships complete with factory assembled mobile post kits, 8 mobile shelf traverses, mobile shelf traverse dovetails, 16 angled drying cradles and premium swivel casters with total locking brake. Assembly required.

CODE	DIMENSIONS D x L x H	HOLDING CAPACITY
EMU244878PDPKG	610 x 1220 x 1980 mm	128 Pellets and Bases or 16 GN 1/1 Food Pans

Color: Brushed Graphite (580).

Ships in



5



CAMSHELVING® **BASICS PLUS** series

WHY CHOOSE BASICS PLUS?

Just because the budget is tight and storage needs are less rigorous, it doesn't mean that shelving performance and storage efficiencies should be compromised. Basics Plus Series is made from the same high performing, strong composite material as Elements Series and has the same design features. It's lighter in weight and less in cost but still strong enough to handle light to medium storage demands.



All Environments
-38°C TO 88°C

Stationary



COMPONENT

Post Connectors, Corner Connectors, Seismic Foot, Wall Fastener, Identification Tags, Single Shelf Security Cage, and Tray Slide Rack are not NSF Listed.



storage needs
LIGHT to MEDIUM

weekly deliveries
2 – 5

CAMSHELVING® BASICS PLUS SERIES

STATIONARY UNIT SIZES

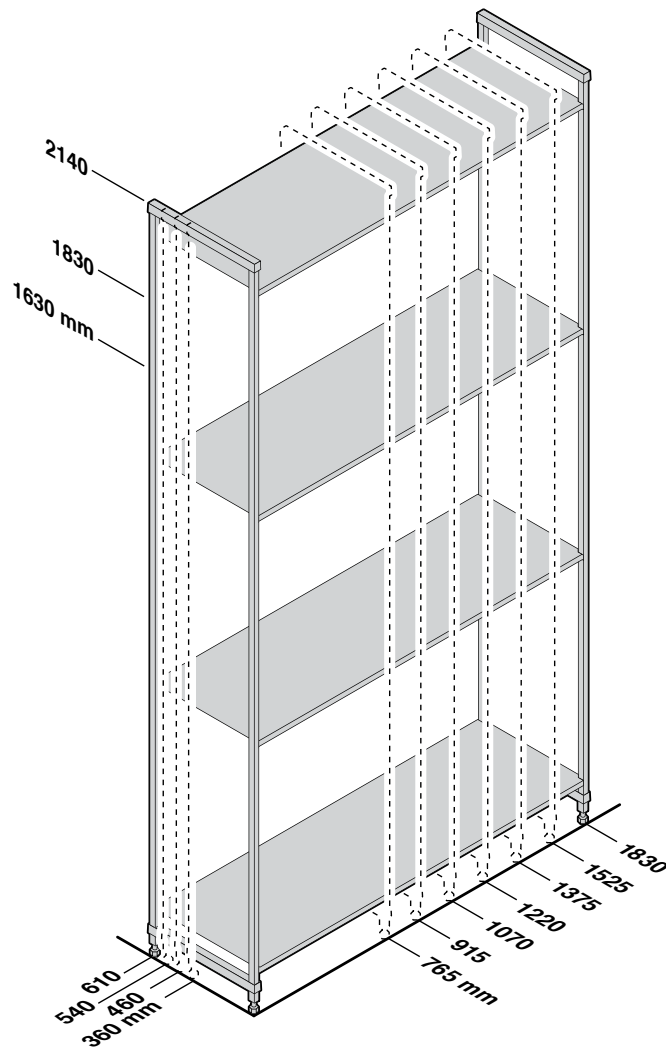

BASICS PLUS SERIES WEIGHT BEARING CAPACITY

Weight must be evenly distributed across the entire shelf.

		UNIT LENGTH 765 – 1220 MM	UNIT LENGTH 1375 – 1525 MM
SINGLE UNIT	Unit only	800 kg (TUV)	800 kg (TUV)
	Shelf only	190 (TUV)	180 (TUV)
	Unit with dunnage stand*	885	880
	Bottom shelf with dunnage stand*	275	260
CORNER UNIT with 2 dunnage stands required	Unit only	590	—
	Shelf only	130	—
	Bottom shelf with dunnage stands*	200	—

*Dunnage Stands add stability and increase weight bearing capacity on bottom shelf only. Highly recommended for Starter Units 1375 mm and longer, all Corner Units, U-Shape Units and units specified for heavier loads. (See page 96).



TUV CERTIFICATION
WEIGHT BEARING CAPACITY

CAMSHELVING® BASICS PLUS SERIES

Starter, and Add-On Units

These units make ordering easy and save time and labor during installation. Units ship complete in one box. Post kits are pre-assembled at the factory, speeding up on site set up.



4-Shelf Vented Stationary Starter and Add-On Units

Starter units include 2 factory assembled post kits and shelves.

Add-On units include 1 factory assembled post kit and shelves.

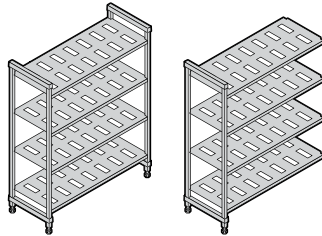

HEIGHTS	DEPTHS	LENGTHS
3	4	7
1630 mm	*360 mm	765 mm 1375 mm
1830	460	915 1525
2140	540	1070 1830
	610	1220

*360 mm only available in: H 1630, 1830 / L 765, 915, 1070, 1220 mm.

Ships in  1

4-Shelf Solid Stationary Starter and Add-On Units

Starter units include 2 factory assembled post kits and shelves.

Add-On units include 1 factory assembled post kit and shelves.

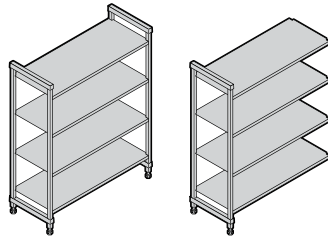

HEIGHTS	DEPTHS	LENGTHS
3	4	7
1630 mm	*360 mm	765 mm 1375 mm
1830	460	915 1525
2140	540	1070 1830
	610	1220

*360 mm only available in: H 1630, 1830 / L 765, 915, 1070, 1220 mm.

Ships in  1

4-Shelf Vented and Solid Stationary Starter and Add-On Units (3 vented + 1 solid)

Starter units include 2 factory assembled post kits and shelves.

Add-On units include 1 factory assembled post kit and shelves.

Install solid shelf on bottom to prevent water/cleaning solutions from sloshing up onto stored products. Install solid shelf on top to protect product stored on lower shelves from condensation in cooler.

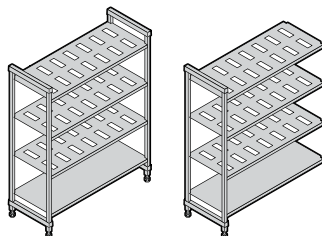

HEIGHTS	DEPTHS	LENGTHS
3	4	7
1630 mm	*360 mm	765 mm 1375 mm
1830	460	915 1525
2140	540	1070 1830
	610	1220

*360 mm only available in: H 1630, 1830 / L 765, 915, 1070, 1220 mm.

Ships in  1

5-Shelf Vented Stationary Starter and Add-On Units

Starter units include 2 factory assembled post kits and shelves.

Add-On units include 1 factory assembled post kit and shelves.

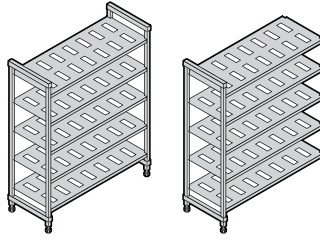

HEIGHTS	DEPTHS	LENGTHS	
3	3	7	
1630 mm	460 mm	765 mm	1375 mm
1830	540	915	1525
2140	610	1070	1830
		1220	

Ships in  1

5-Shelf Solid Stationary Starter and Add-On Units

Starter units include 2 factory assembled post kits and shelves.

Add-On units include 1 factory assembled post kit and shelves.

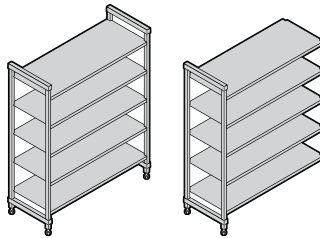

HEIGHT	DEPTHS	LENGTHS	
1	3	7	
2140 mm	460 mm	765 mm	1375 mm
	540	915	1525
	610	1070	1830
		1220	

Ships in  1

5-Shelf Vented and Solid Stationary Starter And Add-On Units (4 vented + 1 solid)

Starter units include 2 factory assembled post kits and shelves.

Add-On units include 1 factory assembled post kit and shelves.

Install solid shelf on bottom to prevent water/cleaning solutions from sloshing up onto stored products. Install solid shelf on top to protect product stored on lower shelves from condensation in cooler.

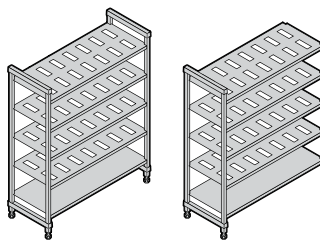

HEIGHT	DEPTHS	LENGTHS	
1	3	7	
2140 mm	460 mm	765 mm	1375 mm
	540	915	1525
	610	1070	1830
		1220	

Ships in  1

scan



Visit the Camshelving website at www.cambro.com/camshelving for product information, assembly videos and design layouts, or to view or download the Camshelving Specification and Price List.

BASICS PLUS SERIES
1630
mm
HEIGHT

V4
4-SHELF VENTED UNITS

Starter units include 2 factory assembled post kits and shelves. Add-on units include 1 factory assembled post kit and shelves. Units ship complete in 1 box.

Starter

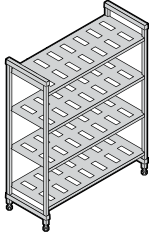

Add-On

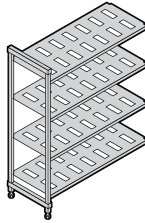

360 mm DEPTH

CODE	DIMENSIONS D x L x H
CBU143064V4	360 x 765 x 1630 mm
CBU143664V4	360 x 915 x 1630
CBU144264V4	360 x 1070 x 1630
CBU144864V4	360 x 1220 x 1630
CBU145464V4	360 x 1375 x 1630
CBU146064V4	360 x 1525 x 1630
CBU147264V4	360 x 1830 x 1630

CODE	DIMENSIONS D x L x H
CBA143064V4	360 x 718 x 1630 mm
CBA143664V4	360 x 870 x 1630
CBA144264V4	360 x 1023 x 1630
CBA144864V4	360 x 1175 x 1630
CBA145464V4	360 x 1328 x 1630
CBA146064V4	360 x 1480 x 1630
CBA147264V4	360 x 1785 x 1630

460 mm DEPTH

CBU183064V4	460 x 765 x 1630 mm
CBU183664V4	460 x 915 x 1630
CBU184264V4	460 x 1070 x 1630
CBU184864V4	460 x 1220 x 1630
CBU185464V4	460 x 1375 x 1630
CBU186064V4	460 x 1525 x 1630
CBU187264V4	460 x 1830 x 1630

CBA183064V4	460 x 718 x 1630 mm
CBA183664V4	460 x 870 x 1630
CBA184264V4	460 x 1023 x 1630
CBA184864V4	460 x 1175 x 1630
CBA185464V4	460 x 1328 x 1630
CBA186064V4	460 x 1480 x 1630
CBA187264V4	460 x 1785 x 1630

540 mm DEPTH

CBU213064V4	540 x 765 x 1630 mm
CBU213664V4	540 x 915 x 1630
CBU214264V4	540 x 1070 x 1630
CBU214864V4	540 x 1220 x 1630
CBU215464V4	540 x 1375 x 1630
CBU216064V4	540 x 1525 x 1630
CBU217264V4	540 x 1830 x 1630

CBA213064V4	540 x 718 x 1630 mm
CBA213664V4	540 x 870 x 1630
CBA214264V4	540 x 1023 x 1630
CBA214864V4	540 x 1175 x 1630
CBA215464V4	540 x 1328 x 1630
CBA216064V4	540 x 1480 x 1630
CBA217264V4	540 x 1785 x 1630

610 mm DEPTH

CBU243064V4	610 x 765 x 1630 mm
CBU243664V4	610 x 915 x 1630
CBU244264V4	610 x 1070 x 1630
CBU244864V4	610 x 1220 x 1630
CBU245464V4	610 x 1375 x 1630
CBU246064V4	610 x 1525 x 1630
CBU247264V4	610 x 1830 x 1630

CBA243064V4	610 x 718 x 1630 mm
CBA243664V4	610 x 870 x 1630
CBA244264V4	610 x 1023 x 1630
CBA244864V4	610 x 1175 x 1630
CBA245464V4	610 x 1328 x 1630
CBA246064V4	610 x 1480 x 1630
CBA247264V4	610 x 1785 x 1630

Color: Brushed Graphite (580).

STOCK PRODUCTS & COLORS AVAILABLE IN OUR EUROPEAN WAREHOUSE

ALL SIZES: (580)

BASICS PLUS SERIES
1830
mm
HEIGHT

V4
4-SHELF VENTED UNITS

Starter units include 2 factory assembled post kits and shelves. Add-on units include 1 factory assembled post kit and shelves. Units ship complete in 1 box.

Starter

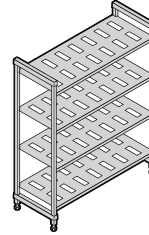

Add-On

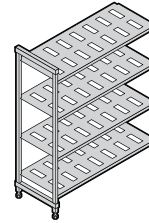

360 mm DEPTH

CODE	DIMENSIONS D x L x H
CBU143072V4	360 x 765 x 1830 mm
CBU143672V4	360 x 915 x 1830
CBU144272V4	360 x 1070 x 1830
CBU144872V4	360 x 1220 x 1830
CBU145472V4	360 x 1375 x 1830
CBU146072V4	360 x 1525 x 1830
CBU147272V4	360 x 1830 x 1830

CODE	DIMENSIONS D x L x H
CBA143072V4	360 x 718 x 1830 mm
CBA143672V4	360 x 870 x 1830
CBA144272V4	360 x 1023 x 1830
CBA144872V4	360 x 1175 x 1830
CBA145472V4	360 x 1328 x 1830
CBA146072V4	360 x 1480 x 1830
CBA147272V4	360 x 1785 x 1830

460 mm DEPTH

CBU183072V4	460 x 765 x 1830 mm
CBU183672V4	460 x 915 x 1830
CBU184272V4	460 x 1070 x 1830
CBU184872V4	460 x 1220 x 1830
CBU185472V4	460 x 1375 x 1830
CBU186072V4	460 x 1525 x 1830
CBU187272V4	460 x 1830 x 1830

CBA183072V4	460 x 718 x 1830 mm
CBA183672V4	460 x 870 x 1830
CBA184272V4	460 x 1023 x 1830
CBA184872V4	460 x 1175 x 1830
CBA185472V4	460 x 1328 x 1830
CBA186072V4	460 x 1480 x 1830
CBA187272V4	460 x 1785 x 1830

540 mm DEPTH

CBU213072V4	540 x 765 x 1830 mm
CBU213672V4	540 x 915 x 1830
CBU214272V4	540 x 1070 x 1830
CBU214872V4	540 x 1220 x 1830
CBU215472V4	540 x 1375 x 1830
CBU216072V4	540 x 1525 x 1830
CBU217272V4	540 x 1830 x 1830

CBA213072V4	540 x 718 x 1830 mm
CBA213672V4	540 x 870 x 1830
CBA214272V4	540 x 1023 x 1830
CBA214872V4	540 x 1175 x 1830
CBA215472V4	540 x 1328 x 1830
CBA216072V4	540 x 1480 x 1830
CBA217272V4	540 x 1785 x 1830

610 mm DEPTH

CBU243072V4	610 x 765 x 1830 mm
CBU243672V4	610 x 915 x 1830
CBU244272V4	610 x 1070 x 1830
CBU244872V4	610 x 1220 x 1830
CBU245472V4	610 x 1375 x 1830
CBU246072V4	610 x 1525 x 1830
CBU247272V4	610 x 1830 x 1830

CBA243072V4	610 x 718 x 1830 mm
CBA243672V4	610 x 870 x 1830
CBA244272V4	610 x 1023 x 1830
CBA244872V4	610 x 1175 x 1830
CBA245472V4	610 x 1328 x 1830
CBA246072V4	610 x 1480 x 1830
CBA247272V4	610 x 1785 x 1830

BASICS
PLUS
SERIES

2140
mm
HEIGHT

V5 5-SHELF VENTED UNITS

Starter units include 2 factory assembled post kits and shelves. Add on units include 1 factory assembled post kit and shelves. Units ship complete in 1 box.

Starter

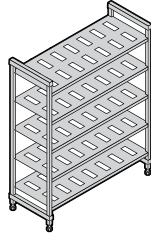

Add-On

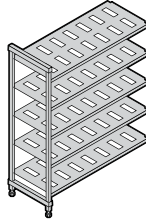

360 mm DEPTH

CODE	DIMENSIONS D x L x H
CBU143084V5	360 x 765 x 2143 mm
CBU143684V5	360 x 915 x 2143
CBU144284V5	360 x 1070 x 2143
CBU144884V5	360 x 1220 x 2143
CBU145484V5	360 x 1375 x 2143
CBU146084V5	360 x 1525 x 2143
CBU147284V5	360 x 1830 x 2143

CODE	DIMENSIONS D x L x H
CBA143084V5	360 x 718 x 2143 mm
CBA143684V5	360 x 870 x 2143
CBA144284V5	360 x 1023 x 2143
CBA144884V5	360 x 1175 x 2143
CBA145484V5	360 x 1328 x 2143
CBA146084V5	360 x 1480 x 2143
CBA147284V5	360 x 1785 x 2143

460 mm DEPTH

CBU183084V5	460 x 765 x 2143 mm
CBU183684V5	460 x 915 x 2143
CBU184284V5	460 x 1070 x 2143
CBU184884V5	460 x 1220 x 2143
CBU185484V5	460 x 1375 x 2143
CBU186084V5	460 x 1525 x 2143
CBU187284V5	460 x 1830 x 2143

CBA183084V5	460 x 718 x 2143 mm
CBA183684V5	460 x 870 x 2143
CBA184284V5	460 x 1023 x 2143
CBA184884V5	460 x 1175 x 2143
CBA185484V5	460 x 1328 x 2143
CBA186084V5	460 x 1480 x 2143
CBA187284V5	460 x 1785 x 2143

540 mm DEPTH

CBU213084V5	540 x 765 x 2143 mm
CBU213684V5	540 x 915 x 2143
CBU214284V5	540 x 1070 x 2143
CBU214884V5	540 x 1220 x 2143
CBU215484V5	540 x 1375 x 2143
CBU216084V5	540 x 1525 x 2143
CBU217284V5	540 x 1830 x 2143

CBA213084V5	540 x 718 x 2143 mm
CBA213684V5	540 x 870 x 2143
CBA214284V5	540 x 1023 x 2143
CBA214884V5	540 x 1175 x 2143
CBA215484V5	540 x 1328 x 2143
CBA216084V5	540 x 1480 x 2143
CBA217284V5	540 x 1785 x 2143

610 mm DEPTH

CBU243084V5	610 x 765 x 2143 mm
CBU243684V5	610 x 915 x 2143
CBU244284V5	610 x 1070 x 2143
CBU244884V5	610 x 1220 x 2143
CBU245484V5	610 x 1375 x 2143
CBU246084V5	610 x 1525 x 2143
CBU247284V5	610 x 1830 x 2143

CBA243084V5	610 x 718 x 2143 mm
CBA243684V5	610 x 870 x 2143
CBA244284V5	610 x 1023 x 2143
CBA244884V5	610 x 1175 x 2143
CBA245484V5	610 x 1328 x 2143
CBA246084V5	610 x 1480 x 2143
CBA247284V5	610 x 1785 x 2143

Color: Brushed Graphite (580).

**STOCK PRODUCTS & COLORS AVAILABLE
IN OUR EUROPEAN WAREHOUSE**

ALL SIZES: (580)

CAMSHELVING® BASICS PLUS SERIES ACCESSORIES

Bottom Shelf Dunnage Stands

Increase weight bearing capacity on bottom shelf only. Add to any shelf length. Highly recommended for starter units 1375 mm and longer and all corner units, intermediate units and units specified for heavier load volume on and off bottom shelves.



CODE	DIMENSIONS D x H
Dunnage Stand – Low	
CBDS14H6	360 x 171 mm
CBDS18H6	460 x 171
CBDS21H6	540 x 171
CBDS24H6	610 x 171
Dunnage Stand – Tall	
CBDS14H10	360 x 273 mm
CBDS18H10	460 x 273
CBDS21H10	540 x 273
CBDS24H10	610 x 273



Case Pack: 1
Color: Brushed Graphite (580).

**STOCK PRODUCTS & COLORS
AVAILABLE IN OUR EUROPEAN
WAREHOUSE**

CBDS18H6, CBDS21H6, CBDS24H6: (151)

Shelf Traverses

Available in single or double packs. Use a single set to add an open shelf for divider bars or drying racks. Add single traverses onto back posts for extra support when placing rolling equipment under the first shelf. Traverse dovetails included.



LENGTH	SINGLE PACK CODE*	DOUBLE PACK CODE**
765 mm	CBTR30	CBTR302PK
915	CBTR36	CBTR362PK
1070	CBTR42	CBTR422PK
1220	CBTR48	CBTR482PK
1375	CBTR54	CBTR542PK
1525	CBTR60	CBTR602PK
1830	CBTR72	CBTR722PK

*Case Pack: 1 **Case Pack: 2
Color: Brushed Graphite (580).

CAMSHELVING® BASICS PLUS SERIES ACCESSORIES

Corner Connectors

Unique patented design ensures maximum shelf space utilization. Use 1 set per shelf to connect starter and add-on units in corners. Connect 4 or 5 intermediate shelves between 2 starter units (2 sets required per shelf). Available as a single set or 8 or 10 set packs.

STOCK PRODUCTS & COLORS AVAILABLE IN OUR EUROPEAN WAREHOUSE

ALL SIZES: (580)

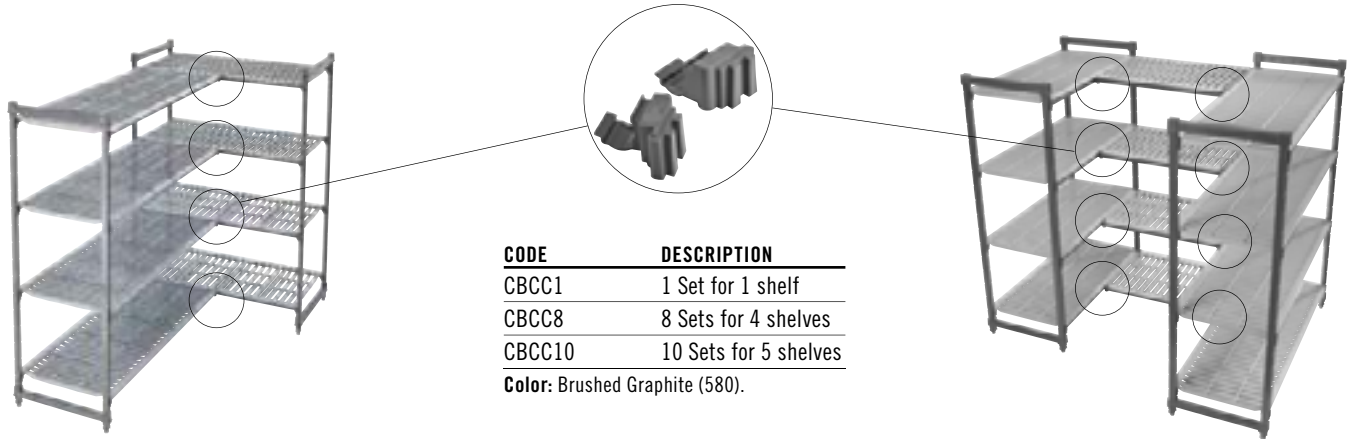

CODE	DESCRIPTION
CBCC1	1 Set for 1 shelf
CBCC8	8 Sets for 4 shelves
CBCC10	10 Sets for 5 shelves

Color: Brushed Graphite (580).

Identification Tag

Clip onto shelf traverses to clearly identify stored product. Made of highly durable plastic with a clear slide in front panel. Labels included.

CODE	DESCRIPTION	DIMENSION L x H
CBID6	152 mm ID Tag	152 x 25 mm

Case Pack: 12 **Color:** White / Clear.

STOCK PRODUCTS & COLORS AVAILABLE IN OUR EUROPEAN WAREHOUSE

CBID6: (000)



Wall Fastener

Use to secure stationary shelving unit to a wall for added safety and stability where required. Made of stainless steel. Screws not included.

CODE	DIMENSION D x L x H
CSWF	73 x 238 x 48 mm

Case Pack: 4 **Color:** Silver (000).



Hole diameter 1,11 cm

STOCK PRODUCTS & COLORS AVAILABLE IN OUR EUROPEAN WAREHOUSE

CSWF: (000)



Seismic Foot

Secure stationary unit posts directly to the floor for added safety and stability where required. Made of stainless steel. Bolts not included.

CODE	DIMENSION D x L x H
CSEQ3	102 x 83 x 59 mm

Case Pack: 4 **Color:** Silver (000).



Hole diameter 1,43 cm



Shelf Divider

Stack and separate items stored on shelves. Made of highly durable ABS plastic. Installs directly into solid or vented shelves. Easily removable for relocating or washing.

CODE	DIMENSION D x H
CSSD188	460 x 203 mm
CSSD218	540 x 203
CSSD248	610 x 203

Case Pack: 1 **Color:** Soft Grey (151).

STOCK PRODUCTS & COLORS AVAILABLE IN OUR EUROPEAN WAREHOUSE

ALL SIZES: (151)

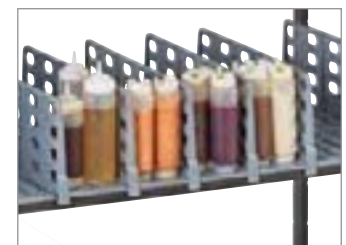

CAMSHELVING® BASICS PLUS SERIES ACCESSORIES

Tray Sliding Rack (for 610 mm deep shelf only)

Holds up to 6 each full size (1826)
46 x 66 cm or 12 half size (1318)
32 x 45 cm sheet pans or trays.
Install 1 or more units onto vented
shelves, any length. High quality,
lightweight aluminum material is
safe for use in coolers and freezers.
Made from aluminum 6463
(6000 series).

CODE	DIMENSION D x L x H
CSTSR	584 x 517 x 508 mm
Case Pack: 1 Color: Silver (000).	

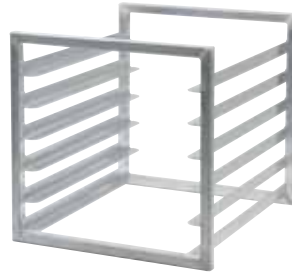

Single Shelf Security Cage (for 610 mm deep shelf only)

Securely store valuable products
on a single shelf. Made of heavy
duty, 304 stainless steel for use
in any environment. Requires
457 mm height between shelves.
Install on vented shelves only.
Lock not included.

CODE	DIMENSION D x L x H
CSSC244818	640 x 1080 x 457 mm
Case Pack: 1 Color: Silver (000).	



Vertical Drying and Storage Cradle (for 610 mm deep shelf only)

Modular 7-slot rack designed for
drying and storing trays, sheet pans,
cutting boards and lids. Installs
directly onto shelf traverses. Made of
highly durable ABS plastic. Available
in single or 3 pack.

CODE	DIMENSIONS D x L x H	CASE PACK
CSDR7	597 x 260 x 95 mm	1
CSDR73	597 x 260 x 95	3
Color: Soft Grey (151).		

**STOCK PRODUCTS &
COLORS AVAILABLE IN OUR
EUROPEAN WAREHOUSE**

CSDR7, CSDR73: (151)



Dome Drying and Storage Cradle (for 540 mm deep shelf only)

Use to dry and safely store up to
10 patient meal delivery domes or
plate covers upright. Installs directly
onto shelf traverses. Made of highly
durable ABS plastic. Available in
single or 5 pack.

CODE	DIMENSIONS D x L x H	CASE PACK
CSDDC	520 x 415 x 86 mm	1
CSDDC5	520 x 415 x 86	5
Color: Soft Grey (151).		



Angled Drying and Storage Cradle (for 610 mm deep shelf only)

Uniquely designed cradle holds up to
8 each meal delivery pellets or
use to dry, store and transport food
pans and other commercial kitchen
ware. Installs directly onto shelf
traverses. Made of highly durable
ABS plastic. Available in single or
4 pack.

CODE	DIMENSIONS D x L x H	CASE PACK
CSDR8	592 x 263 x 160 mm	1
CSDR84	592 x 263 x 160	4
Color: Soft Grey (151).		

**STOCK PRODUCTS &
COLORS AVAILABLE IN OUR
EUROPEAN WAREHOUSE**

CSDR8, CSDR84: (151)



CAMSHELVING® WALL SHELVES AND SHELF EXTENDERS

Wall Shelves

- Expand storage space in kitchens, above work stations and sinks.
- Features virtually indestructible I-beam supports that hold up to 68 kg per shelf.
- Durable polypropylene withstands temperatures up to 88°C, and will not rust or corrode.

- Snap fit rail design allows shelves to snap on and off for easy cleaning.
- 5 cm backsplash and marine front edge controls spills and cross contamination.

Shelf Extenders

- Convert empty wall space into a functional storage area.
- Use with or without Camshelving Wall Shelves.
- Peg strips withstand temperatures up to 88°C, and will not rust or corrode.

Wall Shelf Color: Speckled Grey (480).

Extender Peg Strip Color: Black (110).



COMPONENT



Shelf Extenders ship in one carton and include:

	PEG		
LENGTH	STRIPS	BRACKETS	HOOKS
910 mm	3	2	6
1220 mm	3	3	9

STOCK PRODUCTS & COLORS AVAILABLE IN OUR EUROPEAN WAREHOUSE

CSWS1436SK, CSWS1448SK, CSWS1836SK, CSWS1848SK: (480)

Wall Shelves 360 mm Depth



CODE	CSWS1436SK	CSWS1448SK	CSWS1436VK	CSWS1448VK
DESCRIPTION	910 mm wall shelf, solid	1220 mm wall shelf, solid	910 mm wall shelf, vented	1220 cm wall shelf, vented
EXTERIOR DIMENSIONS	L 915 x D 360 x H 340 mm	L 1220 x D 360 x H 340 mm	L 915 x D 360 x H 340 mm	L 1220 x D 360 x H 340 mm

Case Pack: 1

Wall Shelves 460 mm Depth

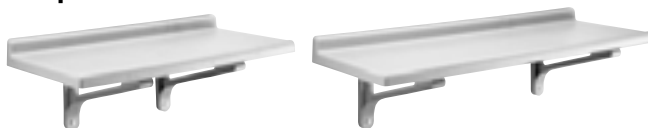

CODE	CSWS1836SK	CSWS1848SK
DESCRIPTION	910 mm wall shelf, solid	1220 mm wall shelf, solid
EXTERIOR DIMENSIONS	L 915 x D 460 x H 340 mm	L 1220 x D 460 x H 340 mm

Case Pack: 1

Shelf Extenders

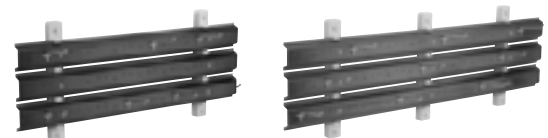

CODE	CSWS36EK	CSWS48EK
DESCRIPTION	910 mm Shelf Extender	1220 mm Shelf Extender
EXTERIOR DIMENSIONS	L 900 x D 50 x H 390 mm	L 1220 x D 50 x H 390 mm

Case Pack: 1

S-SERIES DUNNAGE RACKS AND CAMLINK®



S-Series Dunnage Racks

- Keep frozen, cold or dry inventory 30,5 cm safely off the floor.
- One piece construction and sturdy legs provide strength and stability.
- Heavy duty polypropylene is safe to -38°C, and will not rust, corrode or bend.
- Choose slotted tops for maximum air circulation around perishable products.
- Solid tops catch spills for easy clean up.

Colors: Dark Brown (131),
Speckled Gray (480).



STOCK PRODUCTS & COLORS AVAILABLE IN OUR EUROPEAN WAREHOUSE

DRS300, DRS360, DRS480, DRS600: (480)



CODE	EXTERIOR DIM. H x D x W	LOAD CAPACITY
Solid Top		
DRS30	300 x 533 x 760 mm	680 kg
DRS36	300 x 533 x 915	680
DRS48	300 x 533 x 1220	1,360
DRS60	300 x 533 x 1525	1,360
Slotted Top		
DRS300	300 x 533 x 760	680
DRS360	300 x 533 x 915	680
DRS480	300 x 533 x 1220	1,360
DRS600	300 x 533 x 1525	1,360

Case Pack: 1

Camlink

Camlink connectors securely lock dunnage racks together for greater stability.



CODE	CASE PACK
DRLNK	6

Color: Black (110).

Camlink fits all sizes and styles. One free Camlink supplied with every Dunnage Rack.





supplies

- FOOD STORAGE & PREPARATION
- TABLE SERVICE
- FOOD PRESENTATION
- TRAYS



STORAGE

Quick Guide To Storage Solutions

Camwear® CamSquare®
Food Storage Containers

Camwear Round Food Storage Containers

Camwear Food Storage Boxes

Camwear Food Pans

Camwear Colander Pans

X-Pan® High Heat Food Pans

H-Pan™ High Heat Food Pans

H-Pan High Heat Colander Pans

High Heat H-Pan with Handle(s)

Translucent Polypropylene
Gastronorm Food Pans

Polypropylene Gastronorm
Colander Pans

ColdFest® Gastronorm Pans, Crocks,
Covers & Pumps

StoreSafe® Food Rotation Labels

Pizza Dough Boxes

Ingredient Bins & Camcrisper®

Camwear Scoops & Measuring Cups

QUICK GUIDE TO STORAGE SOLUTIONS



STORAGE CONTAINERS

CamSquares® Food Storage Containers

Keeps food fresh and maximizes storage areas.



7	3	2
SIZES	MATERIALS	LID TYPES

Round Food Storage Containers

Store ingredients or transport ready to serve or partially prepared foods.



8	3	4
SIZES	MATERIALS	LID TYPES

FOOD STORAGE BOXES

Safely store bulk produce, meat, poultry and seafood.



2	5	2	2
SIZES	DEPTHS	MATERIALS	LID TYPES

COLDFEST®

GN Pans

Holds cold food at safe temperatures without ice for hours.



4	1	1	5
SIZES	DEPTH	MATERIAL	LID TYPES



FOOD PANS

Camwear® Food Pans

Store, transport and serve all in one pan. Virtually unbreakable Camwear will not crack, bend or dent. Withstands temperatures from -40° to 99°C.



8	4	3	7
SIZES	DEPTHS	COLORS	LID TYPES

Translucent Food Pans

An economical choice for storage and serving. Ideal for use in cold and ambient environments. Withstands temperatures from -40° to 70°C.



6	2	1	3
SIZES	DEPTHS	COLOR	LID TYPES



X-Pan® High Heat Food Pans

Pans withstand and adapt to different temperatures cold to hot, thus expanding functionality and reducing unnecessary handling. Withstands temperatures from -40° to 190°C.



7	3	1	6
SIZES	DEPTHS	COLOR	LID TYPES



Colander Pans

Liquids drain away from food into the pan below for enhanced food quality and improved food safety.

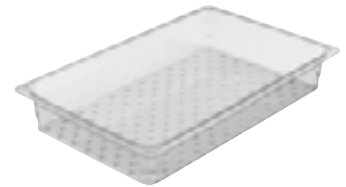

4	2	3	3
SIZES	DEPTHS	MATERIALS	LID TYPES

H-Pan™ High Heat Food Pans

Pans can go from prep to cooler to oven to steam table. Withstands temperatures from -40° to 190°C.



8	3	2	7
SIZES	DEPTHS	COLORS	LID TYPES



Ingredient Bins

Store dry bulk ingredients such as flour and grain.



6	1	3
CAPACITIES	COLOR	LID TYPES

FOOD PAN LIDS

Covers protect contents better than plastic wrap or foil while saving time and money. Lids improve food safety and extend product freshness. Fit selected Camwear, X-Pan®, H-Pan™ high heat and translucent food pans.

7	7	3	5
TYPES	SIZES	MATERIALS	COLORS

Flat Cover

Basic cover available in all pan sizes.



Notched FlipLid

FlipLid with notch to rest spoon in contents with lid closed.



Cover with Handle

Deep molded handle provides secure grip. Includes peg hole for sanitary drying.



Seal Cover for Camwear® and Translucent Food Pans

Translucent seal covers provides an inner seal, to protect food quality while eliminating the expense of plastic wrap.



Notched Cover with Handle

Notched cover allows utensils to remain in pan and off of potentially contaminated counters. Includes peg hole for sanitary drying.



GripLid®

Lid grips the side of the pan, reducing spills and points of cross contamination. Fits Camwear and High Heat pans.



FlipLid®

Keeps contents covered yet flips up easily for service.



MATERIALS

Camwear

Virtually unbreakable Camwear material will not crack, bend or dent. Withstands temperatures from -40° to 99°C.



Polypropylene

Translucent polypropylene material provides a high chemical resistance. Withstands temperatures from -40° to 70°C.



Polyethylene

High chemical and impact resistant material. Withstands temperatures from -40° to 70°C.



X-Pan High Heat

Ideal for use in microwaves, steam tables, ovens and hot holding applications. Withstands temperatures from -40° to 190°C.



H-Pan High Heat

High Heat Material is safe for heating and holding applications. Withstands temperatures from -40° to 190°C.



ABS

High-performance and impact resistant material. Ideal for temperatures at or below 4°C.



CAMWEAR® CAMSQUARE® FOOD STORAGE CONTAINERS



Maximize your storage area with CamSquare food storage containers. The square shape provides 33% better space usage than traditional round containers. Clear Camwear provides product visibility for at a glance inventory management. Seal covers feature an inner and outer seal for superior spill resistance, even during transport.

Note: All graduations are approximate.

Dimensions include handles.



2
PRORATED

Tight fitting Seal Cover is spill resistant, saves expense & safer for employees to handle during transport.



Interstacking saves space when not in use.

Wide molded-in handles ease carrying larger size. Molded-in holes offer quick and sanitary drying.

Crystal clear, virtually unbreakable Camwear withstands temperatures from -40° to 99°C.

Stain and odor resistant.

Easy to read engraved graduations printed on the outside for quick inventory management.

Seal Covers for Camwear CamSquare*

- Inner and outer seal provide excellent spill resistance.
- Includes a hole on the corner for hanging during storage.
- Translucent lid easily identifies contents.
- Withstands temperatures from -40° to 70°C.



*Seal covers only fit Camwear Square Containers.

CAMSQUARE® TRANSLUCENT POLYPROPYLENE & POLYETHYLENE FOOD STORAGE CONTAINERS

Translucent Polypropylene

- Translucent material provides some content visibility and high chemical resistance.
- Withstands temperatures from -40° to 70°C.
- Easy to read graduations are printed on the outside for at a glance inventory management.

Note: All graduations are approximate.



Polyethylene

- Economical storage choice.
- Made of impact, stain and chemical resistant material.
- Withstands temperatures from -40° to 70°C.

Note: All graduations are approximate.



Covers for CamSquares

- Snap-tight polyethylene covers feature thumb tabs for easy removal.
- Poly covers fit Camwear®, Translucent and Polyethylene CamSquare Containers.



Personalized Storage Products

Personalize food storage products to identify menu items, add fill lines for recipes, or use personalization in multiple languages to help ensure product quality and consistency.



CAMWEAR® CAMSQUARE® FOOD STORAGE CONTAINERS



Camwear



CODE	2SFSCW	4SFSCW	6SFSCW	8SFSCW	12SFSCW**	18SFSCW**	22SFSCW**
CAPACITY	1,9 L	3,8 L	5,7 L	7,6 L	11,4 L	17,2 L	20,8 L
DIM. L x W x H (CM)	18,5 x 18,5 x 10	18,5 x 18,5 x 18,7	21,5 x 21,5 x 18,5	21,5 x 21,5 x 23	25,6 x 31 x 21	25,6 x 31 x 32	25,6 x 31 x 40

Case Pack: 6 Color: Clear (135). Height includes covers. **Dimensions include handles.

STOCK PRODUCTS & COLORS AVAILABLE IN OUR EUROPEAN WAREHOUSE

ALL CAMWEAR: (135)

Seal Covers for Camwear CamSquare*



CODE	SFC2SCPP	SFC6SCPP	SFC12SCPP
DESCRIPTION	Fits 1,9 & 3,8 L	Fits 5,7 & 7,6 L	Fits 11,4, 17,2 & 20,8 L

Case Pack: 6 Color: Translucent (190).

STOCK PRODUCTS & COLORS AVAILABLE IN OUR EUROPEAN WAREHOUSE

SFC2SCPP, SFC6SCPP, SFC12SCPP: (190)

Note: All graduations are approximate.

*Seal Covers only fit Camwear CamSquare containers.

Personalization available on non-food contact areas only. See cresting section for information, ordering and pricing.



PRORATED

CAMSQUARE® TRANSLUCENT POLYPROPYLENE & POLYETHYLENE FOOD STORAGE CONTAINERS



Translucent Polypropylene



CODE	2SFSP	4SFSP	6SFSP	8SFSP	12SFSP**	18SFSP**	22SFSP**
CAPACITY	1,9 L	3,8 L	5,7 L	7,6 L	11,4 L	17,2 L	20,8 L
DIM. L x W x H (CM)	18,5 x 18,5 x 10	18,5 x 18,5 x 18,7	21,5 x 21,5 x 18,5	21,5 x 21,5 x 23	25,6 x 31 x 21	25,6 x 31 x 32	25,6 x 31 x 40

Case Pack: 6 Color: Translucent (190). Height includes covers. **Dimensions include handles.

STOCK PRODUCTS & COLORS AVAILABLE IN OUR EUROPEAN WAREHOUSE

2SFSP, 4SFSP, 6SFSP, 8SFSP, 12SFSP, 18SFSP, 22SFSP: (190)

Polyethylene



CODE	2SFSP	4SFSP	6SFSP	8SFSP	12SFSP**	18SFSP**	22SFSP**
CAPACITY	1,9 L	3,8 L	5,7 L	7,6 L	11,4 L	17,2 L	20,8 L
DIM. L x W x H (CM)	18,5 x 18,5 x 10	18,5 x 18,5 x 18,7	21,5 x 21,5 x 18,5	21,5 x 21,5 x 23	25,6 x 31 x 21	25,6 x 31 x 32	25,6 x 31 x 40

Case Pack: 6 Color: Natural White (148). Height includes covers. **Dimensions include handles.

Covers*



CODE	SFC2	SFC6	SFC12
COLOR	Kelly Green (452)	Winter Rose (451)	Midnight Blue (453)
DESCRIPTION	Fits 1,9 & 3,8 L	Fits 5,7 & 7,6 L	Fits 11,4, 17,2 & 20,8 L

Case Pack: 6

STOCK PRODUCTS & COLORS AVAILABLE IN OUR EUROPEAN WAREHOUSE

SFC2: (452)
SFC6: (451)
SFC12: (453)

Note: All graduations are approximate.

*Poly Covers fit Camwear, Translucent and Polyethylene CamSquare Containers.

Personalization available on non-food contact areas only. See cresting section for information, ordering and pricing.



CAMWEAR® ROUND FOOD STORAGE CONTAINERS



Store ingredients or transport ready to serve or partially prepared foods. Clear Camwear allows for easy content identification at a glance. Reduces risk of contamination and enhances food safety. Round shape promotes proper air circulation, ideal for stirring soups and sauces.

Note: All graduations are approximate.

Note: To order Round Food Storage Containers without imprinted graduations, simply add "N" to the end of the code number.

Lids are not interchangeable.



PRORATED



Seal Cover provides excellent spill resistance.

Crystal clear, virtually unbreakable Camwear withstands temperatures from -40° to 99°C.

Molded-in handles ease carrying. Molded-in holes offer quick and sanitary drying.



Interstacking saves space when not in use.

Resists food acids, oils & alcohol. Stain and odor resistant.

Easy to read graduations on the outside for at a glance inventory management.

Camwear Covers

- Snap on covers fit tightly.
- Stain resistant to food acids and oils.
- Withstands temperatures from -40° to 99°C.



Round Seal Covers

- Inner and outer seal provide excellent spill resistance.
- Safe from -40° to 70°C.
- Thumb tab for easy removal.

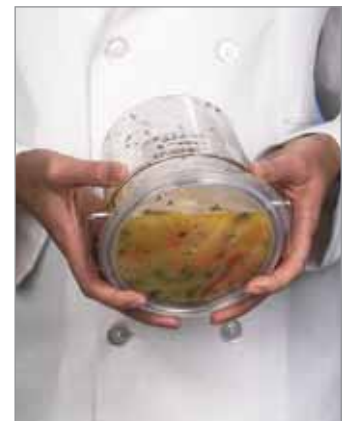

TRANSLUCENT POLYPROPYLENE & POLYETHYLENE ROUND FOOD STORAGE CONTAINERS

Translucent Polypropylene

- Translucent material offers some product visibility.
- Rounds are durable and resistant to stains.
- Withstands temperatures from -40° to 70°C.
- Snap on covers fit tightly to protect contents and extend product freshness.

Note: All graduations are approximate.
.....
Note: To order Round Food Storage Containers without imprinted graduations, simply add "N" to the end of the code number.
.....
Lids are not interchangeable.



Polyethylene

- Impact, stain and chemical resistant material.
- An affordable storage choice.
- Safe from -40° to 70°C.
- Snap on covers fit tightly yet are easily removed.

Note: All graduations are approximate.
.....
Note: To order Round Food Storage Containers without imprinted graduations, simply add "N" to the end of the code number.
.....
Lids are not interchangeable.



CAMWEAR® ROUND STORAGE CONTAINERS



Camwear



CODE	RFSCW1	RFSCW2	RFSCW4	RFSCW6	RFSCW8	RFSCW12	RFSCW18	RFSCW22
CAPACITY	0,9 L	1,9 L	3,8 L	5,7 L	7,6 L	11,4 L	17,2 L	20,8 L
TOP DIAMETER (CM)	15,4	20,8	20,8	25,2	25,2	37,8	37,8	37,8
HEIGHT (CM)	12,7	11,1	21,8	20,2	27,6	21,3	30,5	38,1
CASE PACK	12	12	12	12	12	6	6	6

Color: Clear (135). Top diameter dimension includes handle. Height dimension includes cover. Two year warranty on Camwear Rounds.



Camwear Covers

DESCRIPTION	CASE PACK	CODE
Fits 0,9 L	12	RFSCWC1
Fits 1,9 L & 3,8 L	12	RFSCWC2
Fits 5,7 L & 7,6 L	12	RFSCWC6
Fits 11,4 L, 17,2 L & 20,8 L	6	RFSCWC12

Color: Clear (135).

Seal Covers for Camwear Rounds

DESCRIPTION	CASE PACK	CODE
Fits 0,9 L	12	RFS1SCPP
Fits 1,9 L & 3,8 L	12	RFS2SCPP
Fits 5,7 L & 7,6 L	12	RFS6SCPP
Fits 11,4 L, 17,2 L & 20,8 L	6	RFS12SCPP

Color: Translucent (190).

TRANSLUCENT POLYPROPYLENE & POLYETHYLENE ROUND FOOD STORAGE CONTAINERS



Translucent Polypropylene



CODE	RFS1PP	RFS2PP	RFS4PP	RFS6PP	RFS8PP	RFS12PP	RFS18PP	RFS22PP
CAPACITY	0,9 L	1,9 L	3,8 L	5,7 L	7,6 L	11,4 L	17,2 L	20,8 L
TOP DIAMETER (CM)	15,4	20,8	20,8	25,2	25,2	37,8	37,8	37,8
HEIGHT (CM)	12,7	11,1	21,8	20,2	27,6	21,3	30,5	38,1
CASE PACK	12	12	12	12	12	6	6	6

Color: Translucent (190). Top diameter dimension includes handle. Height dimension includes cover.

Polyethylene



CODE	RFS1	RFS2	RFS4	RFS6	RFS8	RFS12	RFS18	RFS22
CAPACITY	0,9 L	1,9 L	3,8 L	5,7 L	7,6 L	11,4 L	17,2 L	20,8 L
TOP DIAMETER (CM)	15,4	20,8	20,8	25,2	25,2	37,8	37,8	37,8
HEIGHT (CM)	12,7	11,1	21,8	20,2	27,6	21,3	30,5	38,1
CASE PACK	12	12	12	12	12	6	6	6

Color: Natural White (148). Top diameter dimension includes handle. Height dimension includes cover.

Covers for Translucent Polypropylene Rounds

DESCRIPTION	CASE PACK	CODE
Fits 0,9 L	12	RFSC1PP
Fits 1,9 L & 3,8 L	12	RFSC2PP
Fits 5,7 L & 7,6 L	12	RFSC6PP
Fits 11,4 L, 17,2 L & 20,8 L	6	RFSC12PP

Color: Translucent (190).

Covers for Polyethylene Rounds

DESCRIPTION	CASE PACK	CODE
Fits 0,9 L	12	RFSC1
Fits 1,9 L & 3,8 L	12	RFSC2
Fits 5,7 L & 7,6 L	12	RFSC6
Fits 11,4 L, 17,2 L & 20,8 L	6	RFSC12

Color: Natural White (148).

CAMWEAR® FOOD STORAGE BOXES



ELIMINATE THE HAZARD OF CROSS CONTAMINATION

Extend the freshness of ingredients and eliminate points of cross contamination by transferring product into food boxes at the receiving dock. A safe solution for storing bulk fruits and vegetables. Clear Camwear allows visibility for product identification. Snap tight Camwear covers or SlidingLids™, sold separately, won't come off during transportation.

Camwear and Poly Lids are not interchangeable.

SlidingLids are covered by the following U.S. Patents D 447,906 S & 6,540,098 B1.



PRORATED

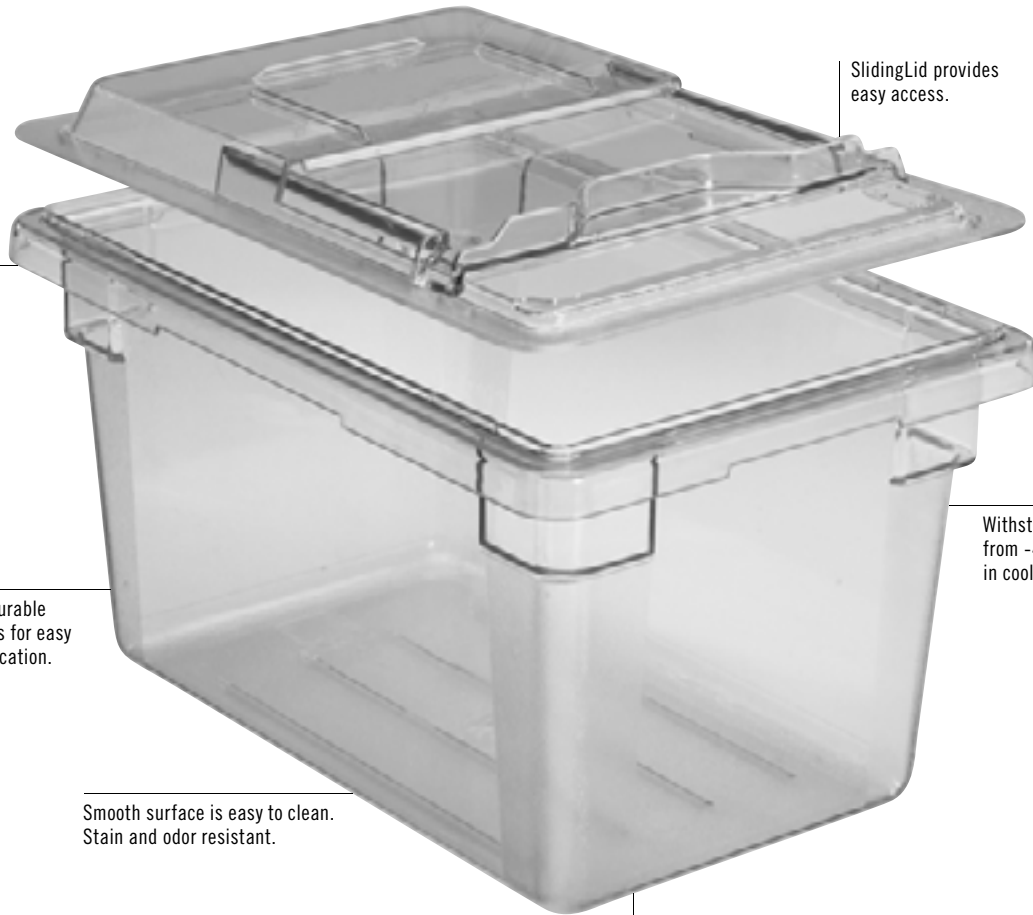

Molded-in handles ease carrying.

SlidingLid provides easy access.

Crystal clear, durable Camwear allows for easy product identification.

Withstands temperatures from -40° to 99°C for use in coolers and freezers.

Smooth surface is easy to clean. Stain and odor resistant.

Texturing on bottom of boxes reduces scratching.

Camwear Flat Lids

- Snap-tight covers won't come off during transport.
- Top molded-in rails for safer, more secure stacking.
- Durable Camwear is safe from -40° to 99°C.

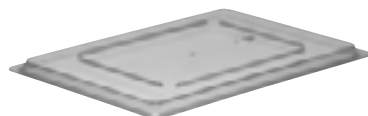

Camwear SlidingLids fits Camwear Food Storage Boxes

- Lid slides back to easily access contents, minimizing handling.
- Reduces the risk of cross contamination since lid remains on food box.
- Made of virtually unbreakable Camwear.



CAMWEAR® & POLYETHYLENE FOOD STORAGE BOXES

Camwear ColanderKits™

- A complete food safety system packaged in one carton.
- Store raw meats, fish on ice or bulk produce safely.
- Juices and liquids drip into the food box below for quick and easy disposal.



- Reduces handling and risk of cross contamination.
- Kit consists of 1 each of 18269CW food box, 1 each 18268CLRCW colander, and 1 each 1826SCCW sliding lid.



Camwear Colanders

- Enhances food quality and reduces risk of cross contamination.
- Liquids and juices drain directly into food box for improved food safety.
- Ideal for draining fruits and vegetables, thawing meat or poultry, or storing seafood on ice.

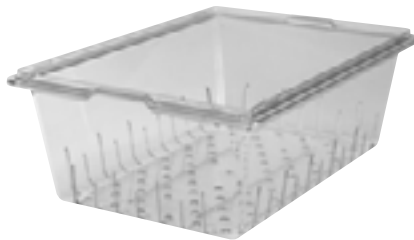

Camwear Drain Shelves

- Lifts contents out of liquids to enhance food quality and freshness.
- Made of virtually unbreakable Camwear.
- Camwear drain shelves fit in both Camwear boxes and white poly boxes.



Polyethylene Food Storage Boxes

- Economical choice for storing bulk produce and ingredients.
- Impact, stain and chemical resistant material.
- Withstands temperatures from -40° to 70°C.



Camwear Safety Red and Yellow Food Storage Boxes

- Helps prevent cross-contamination between raw meats, poultry and other food products.
- Translucent red and yellow color clearly identifies product inside.
- Matching flat cover also available.



CAMWEAR® FOOD STORAGE BOXES



Camwear



CODE	18263CW	❖● 18266CW	18269CW
DIMENSIONS (CM)	46 x 66 x 9	46 x 66 x 15	46 x 66 x 23
APPROX. CAPACITY (L)	18,9	33,1	49,2
CASE PACK	6	6	4



CODE	182612CW	182615CW	12183CW	❖● 12186CW	❖ 12189CW
DIMENSIONS (CM)	46 x 66 x 30	46 x 66 x 38	30,5 x 46 x 9	30,5 x 46 x 15	30,5 x 46 x 23
APPROX. CAPACITY (L)	64,4	83,3	6,6	11,4	18
CASE PACK	4	3	6	6	6

Color: Clear (135). 18266CW & 12186CW available in: ● Safety Red (467), ❖ Safety Yellow (464).

Camwear Covers



CODE	❖● 1826CCW FLAT LID	1826SCCW SLIDINGLID	❖● 1218CCW FLAT LID	1218SCCW SLIDINGLID™
DIMENSIONS (CM)	45,7 x 66	45,7 x 66	30,5 x 45,7	30,5 x 45,7

Case Pack: 6 Color: Clear (135). 1826CCW & 1218CCW available in: ● Safety Red (467), ❖ Safety Yellow (464).

STOCK PRODUCTS & COLORS AVAILABLE IN OUR EUROPEAN WAREHOUSE

18263CW, 18266CW, 18269CW, 182612CW,
182615CW, 12183CW, 12186CW, 12189CW,
1826CCW, 1218CCW: (135)

POLYETHYLENE FOOD STORAGE BOXES & CAMWEAR® ACCESSORIES



Polyethylene Boxes



CODE	18263P	18266P	18269P
DIMENSIONS (CM)	46 x 66 x 9	46 x 66 x 15	46 x 66 x 23
APPROX. CAPACITY	18,9 L	33,1 L	49,2 L
CASE PACK	6	6	6



CODE	182612P	182615P	12183P	12186P	12189P
DIMENSIONS (CM)	46 x 66 x 30	46 x 66 x 38	30,5 x 46 x 9	30,5 x 46 x 15	30,5 x 46 x 23
APPROX. CAPACITY	64,4 L	83,3 L	6,6 L	11,4 L	18 L
CASE PACK	4	3	6	6	6

Color: Natural White (148).

Polyethylene Covers



CODE	1826CP FLAT LID	1218CP FLAT LID
DIMENSIONS (CM)	45,7 x 66	30,5 x 45,7

Color: Natural White (148). Case Pack: 6

STOCK PRODUCTS & COLORS AVAILABLE IN OUR EUROPEAN WAREHOUSE

1826DSCW, 1826CLRCW, 18268CLRCW: (135)
1826CP, 18269P, 182615P: (148)

Camwear and Polyethylene Lids are not interchangeable.

Accessories



CODE	1826DSCW	1218DSCW	1826CLRCW (12,7 CM DEEP)	18268CLRCW (20 CM DEEP)	18268CLRKIT
DESCRIPTION	Drain shelf	Drain shelf	Colander	Colander	ColanderKit™
DIMENSIONS	Fits 46 x 66 cm food storage boxes	Fits 30,5 x 46 cm food storage boxes	Fits Camwear food storage boxes 46 x 66 x 15 cm and deeper	Fits Camwear food storage boxes 46 x 66 x 23 and deeper	One 20 cm deep colander one 46 x 66 x 23 cm food box one 46 x 66 cm SlidingLid™
CASE PACK	6	6	6	4	1 Kit

Color: Clear (135).

CAMWEAR® GASTRONORM FOOD PANS



Store, transport and serve all in one pan. Camwear food pans are made from durable Camwear that will not crack, bend or dent. Precisely designed to Gastronorm GN specifications, with a bottom to reduce food waste. At half the cost of stainless steel, Camwear pans keep contents as cold as metal pans with less condensation. Pans stack neatly without wedging or sticking.

Camwear GN pans are not recommended for steam table or microwave use. See X-Pan® section for these high heat applications.

Colander Pan is covered by U.S. Patent D 528,376 S.

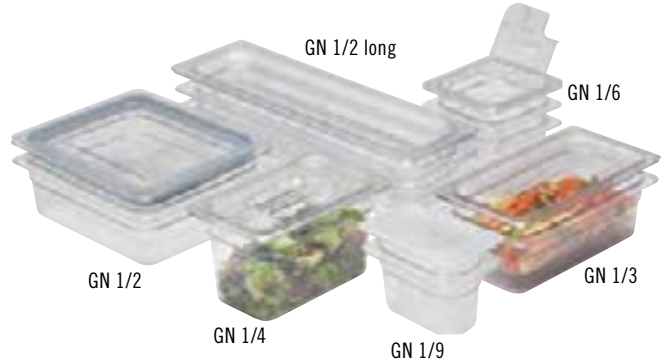

Uniform 1,27 cm flange ensures a smooth fit in prep tables and food bars.

Virtually unbreakable Camwear withstands temperatures from -40° to 99°C.

Molded-in graduations in standard and metric for easy inventory management.



Won't react with food; minimizes potentially hazardous chemical or acidic reaction.

Non-stick smooth interior surface increases yields and promotes easy cleaning.



Textured bottoms resist scratching.

Cold Test

Tests prove Camwear food pans keep products as cold as stainless steel. Stainless steel may feel colder, but as these test results demonstrate, Camwear food pans keep products just as cold for just as long.

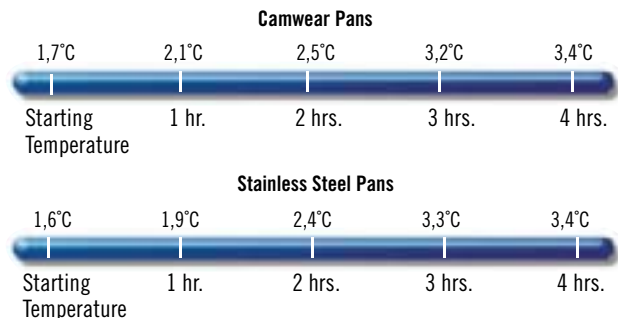

CAMWEAR® GASTRONORM FOOD PANS SIZE, & ORDERING INFORMATION

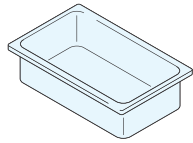

CONFIGURATIONS	PAN CODE	PAN DEPTH	APPROXIMATE CAPACITY
GN 1/1 32,5 x 53 cm	12CW	6,5 cm	8,5 L
	14CW	10	13
	16CW	15	19,5
	18CW	20	25,6
	10CWD	—	Drain shelf

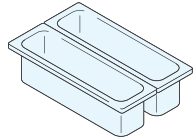

GN 1/2 Long 16,2 x 53 cm	22LPCW	6,5	3
	24LPCW	10	5
	20LPCWD	—	Drain shelf

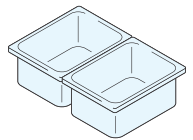

GN 1/2 26,5 x 32,5 cm	22CW	6,5	3,9
	24CW	10	5,9
	26CW	15	8,9
	28CW	20	11,7
	20CWD	—	Drain shelf

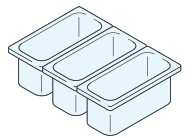

GN 1/3 17,6 x 32,5 cm	32CW	6,5	2,4
	34CW	10	3,6
	36CW	15	5,3
	38CW	20	6,9
	30CWD	—	Drain shelf

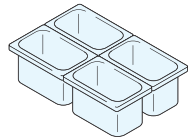

GN 1/4 16,2 x 26,5 cm	42CW	6,5	1,7
	44CW	10	2,5
	46CW	15	3,7
	40CWD	—	Drain shelf

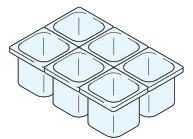

GN 1/6 16,2 x 17,6 cm	62CW	6,5	1
	64CW	10	1,5
	66CW	15	2,2
	60CWD	—	Drain shelf

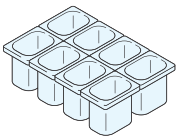

GN 1/8 16,12 x 13,17 cm	82CW*	6,5	0,7
	84CW	10	1
	86CW	15	1,5
	80CWD	—	Drain shelf

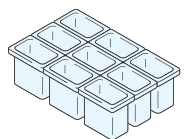

GN 1/9 10,8 x 17,6 cm	92CW	6,5	0,57
	94CW	10	0,85
	96PCW New!	15	1,4
	90CWD	—	Drain shelf

Case Pack for all Pans: 6
Lids listed on page 155. Colanders listed on page 154.

Colors: Clear (135), White (148), Black (110). *82CW is not available in Black (110). 18CW and 28CW available in Clear (135) only.

Drain Shelf Color: Clear (135).
Colander Color: Clear (135).

All Camwear GN Food Pans are made of FDA approved materials. All Camwear GN Food Pans are designed to CEN Gastronorm Standard EN 631-1.

Personalization available on non-food contact areas only. See cresting section for information and ordering.



2
PRORATED

STOCK PRODUCTS & COLORS AVAILABLE IN OUR EUROPEAN WAREHOUSE

10CWD, 18CW, 20CWD, 28CW, 30CWD, 40CWD, 60CWD, 82CW, 84CW, 86CW, 80CWD, 90CWD, 92CW, 96CW: (135)
12CW, 14CW, 16CW, 22LPCW, 24LPCW, 22CW, 24CW, 26CW, 32CW, 42CW, 44CW, 46CW, 62CW, 94CW: (135), (110)
36CW, 64CW, 66CW: (135), (110), (148)
34CW, 38CW: (135), (148)

Drain Shelves

- Support products and promotes drainage.
- Available to fit all pan sizes.



96PCW

CAMWEAR® COLANDER PANS



- Rinse, drain and store all in one pan.
- Liquids drain easily into the food pan below for enhanced food quality and reduced handling.
- Colanders simply lift out of the food pan for safe and quick disposal of liquids.
- Ideal for prepped produce, storing seafood on ice, and defrosting and storing meats and poultry.
- Camwear flat covers, covers with handles and notched covers with handles fit on pans with colanders.

Colander Pans are covered by U.S. Patent D 569,169 S.



13CLRCW

STOCK PRODUCTS & COLORS AVAILABLE IN OUR EUROPEAN WAREHOUSE

13CLRCW, 15CLRCW, 23CLRCW, 25CLRCW, 33CLRCW, 63CLRCW: (135)



Rinse



Drain



Store

CONFIGURATIONS	PAN CODE	COLANDER DEPTH	FITS CAMWEAR PAN DEPTH*
GN 1/1 32,5 x 53 cm	13CLRCW	7,6 cm	10 cm
	15CLRCW	12,7	15
GN 1/2 26,5 x 32,5 cm	23CLRCW	7,6	10
	25CLRCW	12,7	15
GN 1/3 17,6 x 32,5 cm	33CLRCW	7,6	10
	35CLRCW	12,7	15
GN 1/6 16,2 x 17,6 cm	63CLRCW	7,6	10
	65CLRCW	12,7	15



Case Pack for all Pans: 6 Lids listed on following page.
*Fits this pan depth & deeper.

CAMWEAR® LID SIZES & ORDERING INFORMATION



Flat Cover

Available in all pan sizes.



Cover with Handle

Deep molded handle provides secure grip and also includes a peg hole for sanitary drying. Available in black to help block light, reducing discoloration of meats and cheeses.



Notched Cover with Handle

Notched cover allows utensils to remain in pan and off of potentially contaminated counters. Includes peg hole for sanitary drying.



Seal Cover

Designed to fit Camwear and translucent food pans, Seal Covers feature an inner seal that provides superior spill resistance and extends shelf life up to 3 days.



FlipLid®

Flip up lid to easily access contents. Food can be held without getting dried out, increasing yields. Reduces points of cross contamination.



Notched FlipLid

Flip Lid with notch to rest spoon in contents with lid closed.



GripLid®

Molded-in polyurethane gasket on the lid grips the side of the food pan, reducing spills and points of cross-contamination.

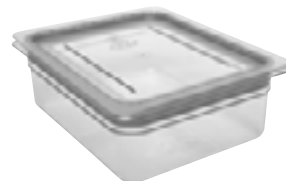

FITS PANS	LID CODE	DESCRIPTION
GN 1/1 32,5 x 53 cm	10CWC	Flat cover
	10CWCH*	Cover with handle
	10CWCHN*	Notched cover with handle
	10CWGL	GripLid
	10PPCWSC	Seal cover
GN 1/2 Long 16,2 x 53 cm	20LPCWC	Flat cover
GN 1/2 26,5 x 32,5 cm	20CWC	Flat cover
	20CWCH*	Cover with handle
	20CWCHN*	Notched cover with handle
	20CWL	FlipLid
	20CWLN	Notched FlipLid
	20CWGL	GripLid
	20PPCWSC	Seal cover
GN 1/3 17,6 x 32,5 cm	30CWC	Flat cover
	30CWCH*	Cover with handle
	30CWCHN*	Notched cover with handle
	30CWL	FlipLid
	30CWLN	Notched FlipLid
	30CWGL	GripLid
	30PPCWSC	Seal cover
GN 1/4 16,2 x 26,5 cm	40CWC	Flat cover
	40CWCH*	Cover with handle
	40CWCHN*	Notched cover with handle
	40PPCWSC	Seal cover
	GN 1/6 16,2 x 17,6 cm	60CWC
60CWCH*		Cover with handle
60CWCHN*		Notched cover with handle
60CWL		FlipLid
60CWLN		Notched FlipLid
60CWGL		GripLid
60PPCWSC		Seal cover
GN 1/8 16,12 x 13,17 cm	80CWC	Flat cover
	80CWCH*	Cover with handle
	80CWCHN*	Notched cover with handle
	80PPCWSC	Seal cover
GN 1/9 10,8 x 17,6 cm	90CWC*	Flat cover
	90CWCN	Flat notched cover
	90PPCWSC	Seal cover

Case pack for all lids: 6 *Includes peg hole.

Color: Clear (135).
Seal Cover Color: Translucent (190).
Cover with Handle Colors: Clear (135), Black (110).

Personalization available on non-food contact areas only. See cresting section for information and ordering.

FlipLids are covered by U.S. Patent Des. 420,849, 422,838 & 427,012. GripLids are covered by U.S. Patent D 446,076 & Utility Patent 6,273,288 B1.



STOCK PRODUCTS & COLORS AVAILABLE IN OUR EUROPEAN WAREHOUSE

10PPCWSC, 20PPCWSC, 30PPCWSC, 40PPCWSC, 60PPCWSC, 80PPCWSC, 90PPCWSC: (190)
 10CWC, 10CWCH, 10CWCHN, 10CWGL, 20LPCWC, 20CWC, 20CWCH, 20CWCHN, 20CWGL, 30CWC, 30CWCH, 30CWCHN, 30CWGL, 40CWC, 40CWCH, 60CWC, 60CWCH, 60CWCHN, 60CWGL, 80CWC, 80CWCH, 90CWC: (135)

GASTRONORM HIGH HEAT X-PAN®

Reduce handling and save expense with one pan that can go from prep to cooler to oven to steam table. X-Pan food pans are designed to Gastronorm GN specifications. Unlike metal pans, they are safe for use in heating and holding applications. Ideal for heated carts, steam tables and chafing dishes. X-Pan food pans have both standard and metric graduation markings to promote easy inventory management.

Color: Sandstone (772).
 X-Pan food pans are made of FDA approved materials and are designed to CEN Gastronorm Standard EN 631-1. Colors may vary.



Uniform 1,27 cm flange ensures a smooth fit in steam tables and food bars.

Great for flash freezing and reheating in microwave ovens.



Pans stack neatly, without wedging or sticking.



Non-stick smooth interior surface increases yields and promotes easy cleaning.

Made from FDA approved material that withstands temperature from -40° to 190°C.



GASTRONORM HIGH HEAT X-PAN®

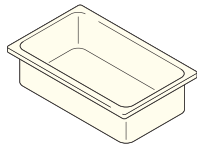

CONFIGURATIONS	PAN CODE	PAN DEPTH	APPROXIMATE CAPACITY
GN 1/1 32,5 x 53 cm	12HP	6,5 cm	8,5 L
	14HP	10	13
	16HP	15	19,5
	10HPD*	—	Drain shelf

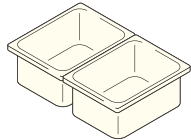

GN 1/2 26,5 x 32,5 cm	22HP	6,5	3,9
	24HP	10	5,9
	26HP	15	8,9
	20HPD*	—	Drain shelf

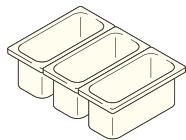

GN 1/3 17,6 x 32,5 cm	32HP	6,5	2,4
	34HP	10	3,6
	36HP	15	5,3
	30HPD*	—	Drain shelf

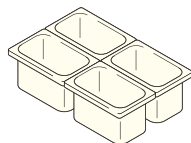

GN 1/4 16,2 x 26,5 cm	42HP	6,5	1,7
	44HP	10	2,5
	46HP	15	3,7
	40HPD*	—	Drain shelf

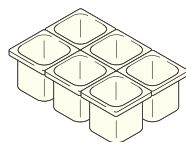

GN 1/6 16,2 x 17,6 cm	62HP	6,5	1
	64HP	10	1,5
	66HP	15	2,2
	60HPD*	—	Drain shelf

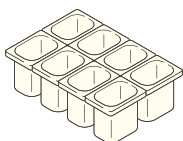

GN 1/8 16,12 x 13,17 cm	82HP	6,5	0,7
	84HP	10	1
	86HP	15	1,5
	80HPD*	—	Drain shelf

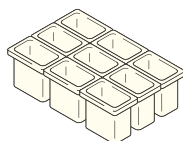

GN 1/9 10,8 x 17,6 cm	92HP	6,5	0,57
	94HP	10	0,85
	90HPD*	—	Drain shelf

Case Pack: 6 Lids listed on page 161. Colanders listed on page 160.
*Drain shelf available in Amber (150) only.

Color: Sandstone (772).
Drain Shelf Color: Amber (150).

X-Pan food pans and drain shelves are made of FDA approved material and are designed to CEN Gastronorm Standard EN 631-1. Colors may vary.



STOCK PRODUCTS & COLORS AVAILABLE IN OUR EUROPEAN WAREHOUSE

12HP, 22HP, 24HP, 26HP, 34HP, 36HP, 66HP: (772)

Drain Shelf

- Supports product and promotes drainage.
- Available to fit all food pan sizes.



34HP

GASTRONORM HIGH HEAT H-PANS™

Reduce handling and save expense with one pan that can go from prep to cooler to oven to steam table. H-Pans are designed to Gastronorm GN specifications. Unlike metal pans, H-Pans are safe for use in heating and holding applications. Ideal for heated carts, steam tables and chafing dishes. H-Pans have both standard and metric graduation markings to promote easy inventory management.

Colors: Amber (150), Black (110).
.....
H-Pans are made of FDA approved material and are designed to CEN Gastronorm Standard EN 631-1.
Amber color may vary.
.....



Uniform 1,27 cm flange ensures a smooth fit in prep tables and food bars.



Pans stack neatly, without wedging or sticking.

Great for flash freezing and reheating.



Non-stick smooth interior surface increases yields and promotes easy cleaning.

Made from FDA approved material that withstands temperatures from -40° to 190°C.



GASTRONORM HIGH HEAT H-PANS™ SIZES & ORDERING INFORMATION

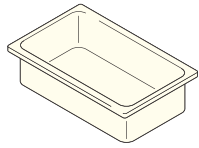

CONFIGURATIONS	PAN CODE	PAN DEPTH	APPROXIMATE CAPACITY
GN 1/1 32,5 x 53 cm	12HP	6,5 cm	8,5 L
	14HP	10	13
	16HP	15	19,5
	10HPD*	—	Drain shelf

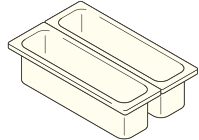

GN 1/2 Long 16,2 x 53 cm	22LPHP	6,5	3
	24LPHP	10	5
	20LPHPD*	—	Drain shelf

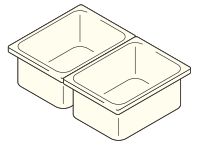

GN 1/2 26,5 x 32,5 cm	22HP	6,5	3,9
	24HP	10	5,9
	26HP	15	8,9
	20HPD*	—	Drain shelf

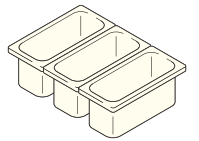

GN 1/3 17,6 x 32,5 cm	32HP	6,5	2,4
	34HP	10	3,6
	36HP	15	5,3
	30HPD*	—	Drain shelf

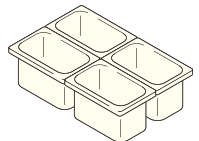

GN 1/4 16,2 x 26,5 cm	42HP	6,5	1,7
	44HP	10	2,5
	46HP	15	3,7
	40HPD*	—	Drain shelf

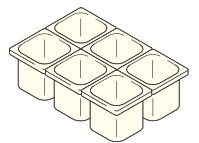

GN 1/6 16,2 x 17,6 cm	62HP	6,5	1
	64HP	10	1,5
	66HP	15	2,2
	60HPD*	—	Drain shelf

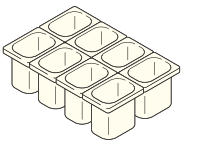

GN 1/8 16,12 x 13,17 cm	82HP	6,5	0,7
	84HP	10	1
	86HP	15	1,5
	80HPD*	—	Drain shelf

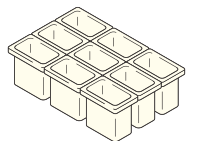

GN 1/9 10,8 x 17,6 cm	92HP	6,5	0,57
	94HP	10	0,85
	96PHP New!	15	1,4
	90HPD*	—	Drain shelf

Case Pack: 6 Lids listed on page 161.
*Drain shelf available in Amber (150) only.

Colors: Amber (150), Black (110).
Drain Shelf Color: Amber (150).

H-Pans are made of FDA approved materials and are designed to CEN Gastronorm Standard EN 631-1. Amber color may vary.

Personalization available on non-food contact areas only. See cresting section for information and ordering.



Drain Shelf

- Supports product and promotes drainage.
- Available to fit all food pan sizes.



See next page for colanders.



86HP

STOCK PRODUCTS & COLORS AVAILABLE IN OUR EUROPEAN WAREHOUSE

14HP, 16HP, 30HPD, 60HPD, 62HP, 64HP: (150)
22LPHP, 24LPHP: (110)
12HP, 22HP, 24HP, 26HP, 34HP, 36HP, 66HP: (110), (150)

H-PAN™ HIGH HEAT COLANDER PANS

- Colanders drain liquids and grease away from hot foods, improving food quality.
- Ideal for reheating in microwaves and holding applications such as steam tables and buffet lines.
- Reduces handling and improves food safety.
- H-Pan flat covers, covers with handles and notched covers with handles fit on pans with colanders.



Microwave/Steam



Hold Hot Foods



Drain

CONFIGURATIONS	PAN CODE	COLANDER DEPTH	FITS H-PAN DEPTH*
GN 1/1 32,5 x 53 cm	13CLRHP	7,6 cm	10 cm
	15CLRHP	12,7	15
GN 1/2 26,5 x 32,5 cm	23CLRHP	7,6	10
	25CLRHP	12,7	15
GN 1/3 17,6 x 32,5 cm	33CLRHP	7,6	10
	35CLRHP	12,7	15
GN 1/6 16,2 x 17,6 cm	63CLRHP	7,6	10
	65CLRHP	12,7	15

Case Pack for all Pans: 6 Lids listed on following page.
*Fits this pan depth & deeper.



LIDS FOR GASTRONORM H-PAN™ AND X-PAN® FOOD PANS AND ORDERING INFORMATION

Flat Cover

Available in all pan sizes.



FITS PANS	LID CODE	DESCRIPTION
GN 1/1 32,5 x 53 cm	10HPC	Flat cover
	10HPCH	Cover with handle
	10HPCHN	Notched cover w/handle
GN 1/2 Long 16,2 x 53 cm	20LPHPC	Flat cover

Cover with Handle

Deep molded handle gives secure grip.



GN 1/2 26,5 x 32,5 cm	20HPC	Flat cover
	20HPCH	Cover with handle
	20HPCHN	Notched cover w/handle
	20HPL	Fliplid
	20HPLN	Notched FlipLid

Notched Cover with Handle

Easy access for ladles or spoons.



GN 1/3 17,6 x 32,5 cm	30HPC	Flat cover
	30HPCH	Cover with handle
	30HPCHN	Notched cover w/handle
	30HPL	FlipLid
	30HPLN	Notched FlipLid

FlipLid®

Flip up lid to easily access contents. Food can be held without getting dried out, increasing yields.



GN 1/4 16,2 x 26,5 cm	40HPC	Flat cover
	40HPCH	Cover with handle
	40HPCHN	Notched cover w/handle

GN 1/6 16,2 x 17,6 cm	60HPC	Flat cover
	60HPCH	Cover with handle
	60HPCHN	Notched cover w/handle
	60HPL	Fliplid
	60HPLN	Notched FlipLid

GN 1/8 16,12 x 13,17 cm	80HPC	Flat cover
	80HPCH	Cover with handle
	80HPCHN	Notched cover w/handle

Notched FlipLid®

Flip Lid with notch to rest spoon in contents with lid closed.



GN 1/9 10,8 x 17,6 cm	90HPC	Flat cover
--------------------------	-------	------------

Case pack for all lids: 6

Color: Amber (150).
Amber color may vary.

Personalization available on non-food contact areas only. See crestring section for information and ordering.

FlipLids are covered by U.S. Patent D 420,849, D 422,838, D 427,012 & D 6,273,288 B1.



STOCK PRODUCTS & COLORS AVAILABLE IN OUR EUROPEAN WAREHOUSE

10HPC, 10HPCH, 20HPC, 20HPCH, 30HPC, 30HPCHN, 60HPC, 60HPCH, 60HPCHN: (150)

HIGH HEAT H-PAN™ WITH HANDLE(S)



- Flat base to maximize contact with heating element.
- High Heat Material withstands temperatures from -40° to 190°C.
- Fits all leading manufacturer's hot holding bins, including single-sided and pass-through models.
- Reinforced textured handle design with finger grip feature for a secure grasp.
- Handle designed with drain holes to avoid water build-up after warewashing process.

Color: Amber (150).



STOCK PRODUCTS & COLORS AVAILABLE IN OUR EUROPEAN WAREHOUSE

32HP1H, 32HP2H: (150)



32HP2H



32HP1H

CONFIGURATIONS	PAN CODE	DESCRIPTION	PAN DEPTH
1/3 17,6 x 32,5 cm	32HP1H	Single Handle	6,5 cm
	32HP2H	Double Handle	6,5

Case Pack: 6

H-Pan with Handles

- Full size 6,5 cm deep food pan with handles fits all leading manufacturers' hot holding bins.
- Two handles allow employees to reach the pan from either side of the unit for safe handling.
- Flat Cover, Cover with Handle and Notched Cover with Handle fit on pan.
- High Heat Material withstands temperatures from -40° to 190°C.



12HPH

CONFIGURATIONS	PAN CODE	PAN DEPTH	APPROX. CAPACITY
1/1 32,5 x 53 cm	12HPH	6,5 cm	8,42 L

Case Pack: 6 Color: Amber (150).
Lids listed on previous page.

TRANSLUCENT POLYPROPYLENE GASTRONORM FOOD PANS

- An economical choice for storing food.
- Translucent polypropylene material provides content visibility and high chemical resistance.
- Withstands temperature ranges from -40° to 70°C.
- Meets Gastronorm GN food pan specifications EN-631-1.
- Non-stick smooth interior surface promotes easy cleaning.

Color: Translucent (190).

 Graduation marks and capacities are approximate.

 Translucent food pans are made of FDA approved materials.

 Translucent food pans interstack with other Cambro food pans.

 Translucent pans are not designed for steam table use.



Ideal for transporting in Cambro top loading carriers. (UPC100, UPCS140, 100MPC, UPC140, UPCS160, 240MPC, UPC160)



Seal covers protect food quality while eliminating the expense of plastic wrap. Available for all Camwear® and translucent food pan sizes.



Uniform 1,27 cm flange width ensures the right fit in prep tables and food bars.



Use Cambro StoreSafe® food rotation labels on translucent food pans to manage inventory and reduce waste.

POLYPROPYLENE GASTRONORM COLANDER PANS

- Rinse, drain and store all in one pan.
- Liquids drain easily into the food pan below for enhanced food quality and reduced handling.
- Translucent Cover w/Handle and Notched Cover with Handle fit on pans with colanders.

Color: Translucent (190).

 Translucent food pans are made of FDA approved materials.

 Translucent pans are not designed for steam table use.



CONFIGURATIONS	PAN CODE	COLANDER DEPTH	FITS POLYPROPYLENE PAN DEPTH*
GN 1/3 17,6 x 32,5 cm	33CLRPP	7,6 cm	10 cm
	35CLRPP	12,7	15
GN 1/6 16,2 x 17,6 cm	63CLRPP	7,6	10
	65CLRPP	12,7	15

Case Pack for all Pans: 6 Lids listed on following page.
 *Fits this pan depth & deeper.

TRANSLUCENT POLYPROPYLENE GASTRONORM FOOD PANS AND LIDS SIZES

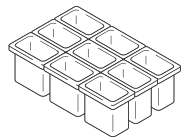
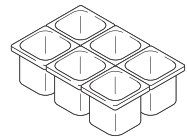
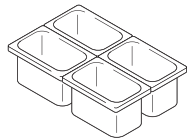
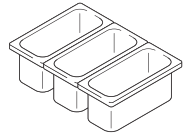
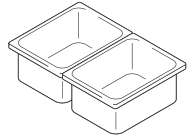
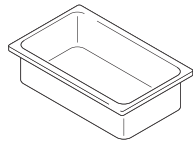

1/1



1/3

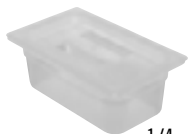

1/4



1/6

CONFIGURATIONS	PAN CODE	PAN DEPTH	APPROXIMATE CAPACITY
GN 1/1 32,5 x 53 cm	12PP*	6,5 cm	8,5 L
	14PP	10	13
	16PP	15	19,5
	18PP*	20	25,6
	10PPD	—	Drain shelf
GN 1/2 26,5 x 32,5 cm	22PP*	6,5	3
	24PP	10	5,9
	26PP	15	8,9
	28PP*	20	11,7
	20PPD	—	Drain shelf
GN 1/3 17,6 x 32,5 cm	32PP	6,5	2,4
	34PP	10	3,6
	36PP	15	5,3
	38PP*	20	6,9
	30PPD	—	Drain shelf
GN 1/4 16,2 x 26,5 cm	42PP	6,5	1,7
	44PP	10	2,5
	46PP	15	3,7
	40PPD	—	Drain shelf
GN 1/6 16,2 x 17,6 cm	62PP	6,5	1
	64PP	10	1,5
	66PP	15	2,2
	60PPD	—	Drain shelf
GN 1/9 10,8 x 17,6 cm	92PP	6,5	0,57
	94PP	10	0,85
	90PPD	—	Drain shelf

FITS PANS	LID CODE	DESCRIPTION
GN 1/1 32,5 x 53 cm	10PPCH	Cover w/ handle
	10PPCWSC	Seal cover
GN 1/2 26,5 x 32,5 cm	20PPCH	Cover w/ handle
	20PPCWSC	Seal cover
GN 1/3 17,6 x 32,5 cm	30PPCH	Cover w/ handle
	30PPCHN	Notched cover w/ handle
	30PPCWSC	Seal cover
GN 1/4 16,2 x 26,5 cm	40PPCH	Cover w/ handle
	40PPCWSC	Seal cover
GN 1/6 16,2 x 17,6 cm	60PPCH	Cover w/ handle
	60PPCHN	Notched cover w/ handle
	60PPCWSC	Seal cover
GN 1/9 10,8 x 17,6 cm	90PPC	Flat cover
	90PPCWSC	Seal cover

Case Pack for all Lids: 6

Color: Translucent (190).

All Translucent Gastronorm Food Pans are made of FDA approved materials.

All polypropylene GN Food Pans are designed to CEN Gastronorm Standard EN 631-1.



STOCK PRODUCTS & COLORS AVAILABLE IN OUR EUROPEAN WAREHOUSE

10PPD, 12PP, 14PP, 16PP, 18PP, 20PPD, 22PP, 24PP, 26PP, 28PP, 30PPD, 32PP, 34PP, 36PP, 38PP, 40PPD, 42PP, 44PP, 46PP, 60PPD, 62PP, 64PP, 66PP, 90PPD, 92PP, 94PP, 10PPCWSC, 20PPCWSC, 30PPCWSC, 40PPCWSC, 60PPCWSC, 90PPCWSC: (190)



Drain Shelf

Available for all food pan sizes.



Cover with Handle

Available for all food pan sizes. Except for GN 1/9 size.



Notched Cover with Handle

Available for GN 1/3 and GN 1/6 food pans.



Seal Cover

Translucent seal covers protect food quality while eliminating the expense of plastic wrap. Available for all pan sizes.



Flat Cover

Only available for GN 1/9 food pans.

COLDVEST® GASTRONORM FOOD PANS, CROCKS, COVERS & PUMPS

- Keeps contents chilled at or below HACCP guidelines of 4°C without the use of messy ice.
- Freeze upside down for eight hours or overnight before filling with pre-chilled product.
- Half and third-size pans hold contents cold for up to eight hours. Sixth size pans and crocks hold contents cold for up to six hours.
- Conforms to Gastronorm exterior dimensions to fit standard food bars or make tables.
- Stackable to save space when freezing and storing.
- Can be used for direct food contact with all types of food products.

Colors: Black (110), White (148).
Flat Cover Color: Clear (135).
Seal Cover Color: White (148).
Pump with Cover Color: Clear (135).

STOCK PRODUCTS & COLORS AVAILABLE IN OUR EUROPEAN WAREHOUSE

ALL PANS/CROCKS: (110), (148)
 20CFC, 30CFC, 60CFC, CFPSRC10, CFPMRC10, CFPFRC10: (135)

Suggested holding times are based on tests with ambient room conditions of up to 23°C.

ColdFest is covered under U.S. Patent D 419,364.

*Pumps and round covers not NSF listed.

All ColdFest GN Food Pans are designed to CEN Gastronorm Standard EN 631-1.



Ideal in Cambro Salad Bars or to keep condiments and creamers chilled.

Pans / Crock



CODE	26CF	36CF	66CF	CFR18
CONFIGURATIONS	GN 1/2 – 26,5 x 32,5 cm	GN 1/3 – 17,6 x 32,5 cm	GN 1/6 – 16,2 x 17,6 cm	ø 17,3 cm
DEPTH	15 cm	15 cm	15 cm	17 cm
APPROX. CAPACITY	6 L	3,5 L	1,4 L	1,6 L

Case Pack: 1



ColdFest Food Pans are made with high-impact resistant ABS shells and non-toxic refrigerant gel cores.

Covers



CODE	20CFC	30CFC	60CFC	CFRC18*	CFRSC18
DESCRIPTION	Flat cover	Flat cover	Flat cover	Flat cover	Seal cover
FITS COLDVEST	GN 1/2	GN 1/3	GN 1/6	Crock	Crock

Case Pack: 2

Pumps with Covers



CODE	CFPSRC10*	CFPMRC10*	CFPFRC10*
DESCRIPTION	Standard pump dispense 29,5 mL portions	Maxi pump for chunky condiments	Fixed nozzle pump for controlled dispensing
DIMENSIONS W x D x H	18,4 x 22,8 x 28,5 cm	18,4 x 26 x 31,4 cm	18,4 x 29,5 x 29,8 cm

Case Pack: 1



STORESAFE® FOOD ROTATION LABELS

- Label and adhesive dissolve in less than 30 seconds.
- Run under hot or cold water or through the dishwasher.
- Safe for all sewer and septic systems and will not build up in drains.
- Withstands freezing temperatures as low as -40°C.
- Withstands high heat temperatures up to 93°C for 4 hours.
- Microwave safe.
- Leaves behind no sticky residue which can be a breeding ground for bacteria.
- Assists in a proper First In First Out (FIFO) food storage system.
- 100% dissolvable and biodegradable.

Label color: White (148).
*Available for ordering in cases only. No broken cartons.
100% biodegradable. FDA approved material.



Eliminates sticky residue and prevents cross contamination! No more scraping!



Dissolves completely off all containers when placed through dishwasher or under running water.

STOCK PRODUCTS & COLORS AVAILABLE IN OUR EUROPEAN WAREHOUSE

1252SLB250, 1252SLINB250, 23SLINB6250, 23SLB250, 23SLINB250



Retail Blister Pack

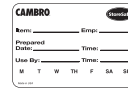

CASE CODE	23SL
LABEL SIZE	5 x 7,6 cm
CASE PACK	20 rolls, 100 labels per roll

StoreSafe Label Blister Pack is covered by U.S. Patent 690,589 S.

Bulk Dispenser Pack – Half Size Labels



CASE CODE	1252SLB250	1252SLINB250
LABEL SIZE	3 x 5 cm	3 x 5 cm
CASE PACK	24 rolls, 250 labels per roll	24 rolls, 250 labels per roll

Bulk Dispenser Pack

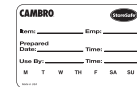
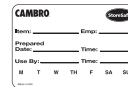

CASE CODE	23SLB250	23SLB6250
LABEL SIZE	5 x 7,6 cm	5 x 7,6 cm
CASE PACK	24 rolls, 250 labels per roll	6 rolls, 250 labels per roll

Bulk Dispenser Pack – Blank Labels

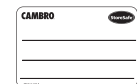
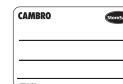

CASE CODE	23SLINB250	23SLINB6250
LABEL SIZE	5 x 7,6 cm	5 x 7,6 cm
CASE PACK	24 rolls, 250 labels per roll	6 rolls, 250 labels per roll

Laser Sheet



BOX CODE	SLL30 (Avery® 5160)
LABEL SIZE	2,54 x 6,35 cm
CASE PACK	100 sheets, 30 labels per sheet 21,6 x 27,9 cm sheet size



PIZZA DOUGH BOXES



DB18263P

Polypropylene

- Ideal for storing, transporting, proofing and cooling dough.
- Lightweight, durable, and break resistant.
- Chemical resistant won't absorb odors and is easy to clean.
- Boxes nest tightly together to keep out dirt and contaminants, extending product freshness.

- Each box acts as a tight lid for the box below, reducing the need and expense of covers.
- Withstands temperatures from -40° to 70°C.
- Cover can be used as an 46 x 66 cm tray.

Color: White (148).

Camwear & Polypropylene dough boxes do not inter stack.

CD1826PDB Color: Coffee Beige (157), Brown(131), Black (110), Slate Blue (401), Grey (180).

*Polypropylene dough boxes are safe for use in high temperature dishwashers.

Caster Type A: 12,7 cm Casters: 2 fixed, 2 swivel, 1 with brake.



CD1826PDB

Capacity: 136 kg
Caster Type: A
Holds: DB18263CW, DB18266CW, DB18263P



STOCK PRODUCTS & COLORS AVAILABLE IN OUR EUROPEAN WAREHOUSE

DB18263P, DBC1826P: (148)

Camwear®

- Prevents crusting to increase the storage life of dough.
- Virtually unbreakable Camwear construction is reinforced on all sides.
- Boxes won't bend or lose their shape.

- Withstands temperatures from -40° to 99°C.
- Available in 7,62 and 15,24 cm depths.



DB18266CW

DB18263CW

CODE	OUTSIDE DIMENSIONS	INSIDE DIMENSIONS
Polypropylene Pizza Dough Box		
DB18263P	46 x 66 x 7,6 cm	40,6 x 60,9 cm
Polypropylene Cover		
DBC1826P	46 x 66	—
Camwear Pizza Dough Boxes		
DB18263CW	46 x 66 x 7,6	40,6 x 60,9
DB18266CW	46 x 66 x 15,3	40,6 x 60,9
Camwear Cover		
DBC1826CW	46 x 66	—

Case Pack: 6 Color: White (148).

Camdolly® For Pizza Dough Boxes

CD1826PDB** 50,5 x 71 x 26 44,5 x 64,5

Case Pack: 1 **Optional Strap Available. See Camdolly section for available colors.

INGREDIENT BINS & CAMCRISPER®



Ingredient Bins

- Store bulk dry ingredients such as flour and grain.
- Hygienic clear sliding lid reduces handling and allows for quick content identification.
- Bin made of FDA-accepted material so no liners are needed.
- Designed to fit under standard work tables.

Camcrisper

- A self-contained system for brining or storing, washing and transporting bulk produce.
- Prevents cross contamination and minimizes unnecessary handling.
- Transfer dry produce out of cartons into bin, cover and roll into cooler for safe storage.
- Wash and rinse produce for easy and safe prep.

Brine Tank

- Designed for complete submersion of meats or poultry in brining solution for enhanced moisture retention, texture and flavor.
- Can also be used as a pre-soak tank for smallwares and dishes in sanitation solution to help reduce labor in pre-scrubbing.
- Clear sliding lid always stays on to help reduce the risk of cross-contamination.

7,6 cm Casters: 2 fixed, 2 swivel.

Color: White (148).

Scoops sold separately. S-Hook included.



STOCK PRODUCTS & COLORS AVAILABLE IN OUR EUROPEAN WAREHOUSE

IBS20, IBS27, IBS37, CC32: (148)



Casters feature wide wheels for excellent stability and weight bearing capability.



CODE	IBS20	IBS27	IBS37	IBSF27
DIMENSIONS W x L x H	33 x 75 x 71 cm	42 x 75 x 71 cm	55 x 75 x 71 cm	33 x 76,5 x 72,5 cm
CAPACITY	81 L	102 L	140 L	102 L
CUBIC METER	0,081	0,102	0,140	0,101
LOAD CAPACITY (SUGAR)	77 kg	103 kg	143 kg	98 kg
LOAD CAPACITY (FLOUR)	63 kg	68 kg	102 kg	68 kg

Case Pack: 1



CODE	IB32	IB36	IB44	CC32 (CAMCRISPER)	IBSD37 (BRINE TANK)
DIMENSIONS W x L x H	56 x 61 x 58,5 cm	39 x 75 x 74 cm	47 x 75 x 74 cm	56 x 61 x 58,5 cm	54,6 x 74,9 x 71,7 cm
CAPACITY	121 L	129 L	161 L	121 L	140 L
CUBIC METER	0,123	0,134	0,160	0,123	0,140
LOAD CAPACITY (SUGAR)	98 kg	114 kg	145 kg	24 lettuce heads (unfinished)	—
LOAD CAPACITY (FLOUR)	73 kg	82 kg	104 kg	42 lettuce heads (finished)	—

Case Pack: 1

CAMWEAR® SCOOPS & MEASURING CUPS

Camwear Scoops

- Virtually unbreakable Camwear will not dent, chip or rust.
- Molded-in sure grip handle includes a hole for hanging.
- Ideal for use with Cambro Ice Caddies and Ingredient Bins.

Color: Clear (135).

Personalization not available.



STOCK PRODUCTS & COLORS AVAILABLE IN OUR EUROPEAN WAREHOUSE

ALL SCOOPS: (135)

CODE	APPROXIMATE CAPACITY	CASE PACK
SCP6CW	170 g	12
SCP12CW	340	12
SCP24CW	680	12
SCP64CW	1814	6



Camwear Measuring Cups

- Externally marked graduations are molded in and imprinted in red for American standard and blue for metric for easy measurement.
- Durable, virtually unbreakable Camwear will not dent, ensuring an accurate measurement every time.
- Molded-in handle will not break off.

Color: Clear (135).

Personalization available on non-food contact areas only. See cresting section for information and ordering.



STOCK PRODUCTS & COLORS AVAILABLE IN OUR EUROPEAN WAREHOUSE

100MCCW, 200MCCW, 400MCCW: (135)

CODE	CAPACITY	CASE PACK
25MCCW	225 mL (dry measure)	12
50MCCW	0,5 L	12
100MCCW	1	12
200MCCW	2	12
400MCCW	4	1

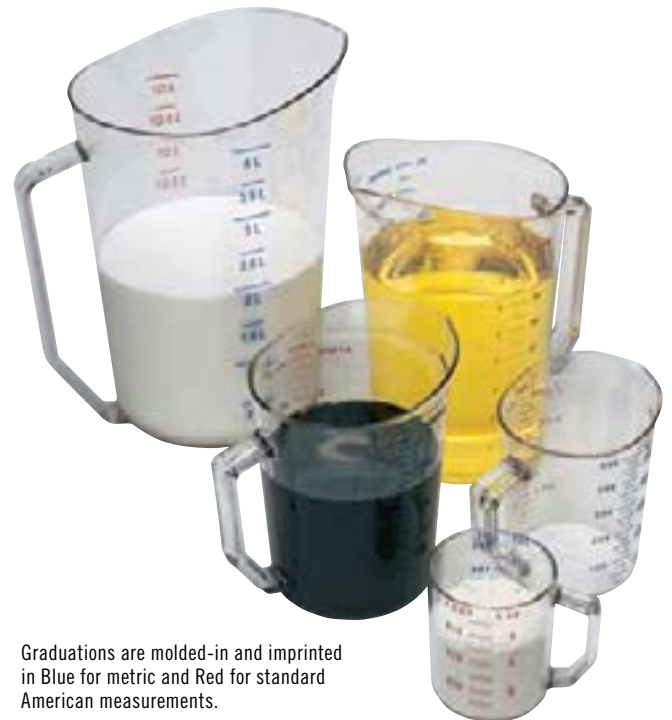

Graduations are molded-in and imprinted in Blue for metric and Red for standard American measurements.

TABLE SERVICE

Camwear® Dinnerware

Versa Camcovers®

Camwear Camcovers

Promote Your Brand

CamView® Pitchers

Aliso® Barware, Goblets and Dessert Glass

Cambro® Tumblers and Disposable CamLids®

CamView® Camliters®

Beverage Dispenser,
Pail with Bail & Swirl Bowls®

Camwear Wine Buckets,
Punch Bowls & Bud Vase



CAMWEAR® DINNERWARE

5 5 YEAR PRORATED WARRANTY AGAINST BREAKAGE

- Durable Camwear resists stains, odors and scratches.
- Textured surface on salad and dinner plates for long wear.
- Ideal for schools, cafeterias, day care centers and healthcare facilities.
- Mug and stacking cup can be personalized.

Not recommended for microwave use.



Oval Platters & Compartment Plates



CODE	90SPCW	120CWP	93CW	HK93BCW
DIAMETER	22,9 x H 4 cm	30,5 x 22,9 cm	22,9 cm	24,1 cm
DESCRIPTION	Round, soup bowl	Oval, narrow rim	Narrow rim	Narrow rim
CASE PACK	48	24	48	12

*HK93BCW is available in Beige (133) only. Not recommended for microwave use.

STOCK PRODUCTS & COLORS AVAILABLE IN OUR EUROPEAN WAREHOUSE

96CW: (135), (148), (401)

Plates



CODE	10CWNR	9CWNR	825CWNR	725CWNR	65CWNR	55CWNR
DIAMETER	25,4 cm	22,9 cm	21 cm	18,4 cm	16,5 cm	14 cm
DESCRIPTION	Narrow rim	Narrow rim	Narrow rim	Narrow rim	Narrow rim	Narrow rim
CASE PACK	48	48	48	48	48	48

Not recommended for microwave use.

Bowls



CODE	10CW*	10CWL	35CW	45CW	50CW	60CW	100CW	150CW
APPROX. CAPACITY	278 mL	—	252 mL	150 mL	452 mL	322 mL	370 mL	494 mL
DESCRIPTION	Square bowl	Lid for 10CW bowl	Bouillon	Fruit cup	Nappie bowl	Grapefruit bowl	Nappie bowl	Square bowl
CASE PACK	48	48	48	48	48	48	48	48
SHAPE	Square	Square	Round	Round	Round	Round	Round	Top/round bottom/square
OUTSIDE DIAMETER	10,2 x 10,2 cm	—	9,8 cm	11,7 cm	13,3 cm	15,2 cm	12,5 cm	Top: 13,3 cm Bottom: 6,4 x 6,4 cm
HEIGHT	4,8 cm	2,2 cm	5,4 cm	3,3 cm	5,4 cm	4 cm	24,3 cm	5,7 cm

Not recommended for microwave use. *Optional lid available.

Mug & Cup



CODE	75CW	96CW
APPROX. CAPACITY	239 mL	288 mL
DESCRIPTION	Stacking cup	Mug
CASE PACK	48	48
MAX DIA./HEIGHT	10,3* cm / 8 cm	10,6* cm / 9,5 cm
FULL SIZE CAMRACK®	16C414	16C414

*Maximum diameter includes handles.

Not recommended for microwave use.

Heat Keepers



CODE	HK93CW	HK39
DESCRIPTION	3 compartment base and cover	Heat Keeper base and cover for 22,9 cm plate
CASE PACK	6	6

HK93CW is available in Beige (133).
HK39 is available in Antique White (148).
Not recommended for microwave use.



HK93PMC

Camcarrier® for HK93CW available by special request. Call Cambro Customer Service for more information.

VERSA CAMCOVERS®

Serve hot food hot with the Versa Camcover, an elegant and efficient alternative to traditional metal covers.

- Withstands temperatures up to 149°C.*
- Covers remain cool to the touch for easy handling.
- Lighter and quieter than metal covers.
- Elegant appearance without polishing.
- Keeps food warm longer than metal covers.

- Available in a variety of sizes in round and square.
- Made of fiberglass material.

Colors: Ivory (380), Granite Gray (191), Antique Parchment (101).

*Microwave safe.

For help selecting the correct size plate cover, refer to the Camcover Sizing Guide on our website at www.cambro.com. Or, send one of your plates to Cambro Customer Service for sizing.



CODE	INSIDE DIAMETER	OUTSIDE HEIGHT	CASE PACK
Square			
85SFVS	20,91 cm	7 cm	12
978SFVS	25,4	7	12
Round			
68VS	16,5	5,6	12
86VS	21	6,7	12
91VS	23,2	6,8	12
913VS	24,9	6,8	12
95VS	23,7	6,8	12
99VS	24,3	6,7	12
911VS	24,6	7	12
100VS	25,4	6,8	12
103VS	25,9	6,8	12
105VS	26,2	6,8	12
106VS	26,4	7,2	12
1010VS	27	6,8	12
1012VS	27,3	6,8	12
1014VS	27,6	6,8	12
116VS	28,9	8,1	12
120VS	30,5	7,3	12
124VS	31,1	7,3	12

CAMWEAR® CAMCOVERS®

- Food stays hot and appetizing without re-heating.
- Ideal for use in heated carts up to 99°C.*
- Made of durable Camwear, will not dent or scratch.
- Lightweight for quiet service.
- Saves on labor with no polishing required.

Colors: Clear (135), Amber (153), Beige (133), Silver (486).

MDCPC9CW Colors: Clear (135), Amber (153), Beige (133), Silver (486).

For help selecting the correct size plate cover, refer to the Camcover Sizing Guide on our website at www.cambro.com. Or, send one of your plates to Cambro Customer Service for sizing.

*Not recommended for microwave use.



STOCK PRODUCTS & COLORS AVAILABLE IN OUR EUROPEAN WAREHOUSE

900CW, 905CW, 9011CW, 1000CW, 1005CW, 1007CW, 1013CW, 1101CW, 1202CW: (152)

CODE	INSIDE DIAMETER	OUTSIDE HEIGHT	CASE PACK
Camwear Camcovers			
806CW	21,4 cm	6,8 cm	12
900CW	23,2	7	12
901CW	23,7	7,2	12
905CW	24,1	7,2	12
909CW	24,8	7	12
9011CW	25,4	7,3	12
9013CW	25,4	7	12
1000CW	25,9	6,8	12
1005CW	26,8	7,2	12
1007CW	27	7	12
1013CW	27,5	6,8	12
1101CW	27,9	6,8	12
1202CW	30,8	7	12
Camwear Low Profile Camcovers			
MDCPC9CW New!	23,2	5	12

PROMOTE YOUR BRAND

Personalize tumblers, barware, pitchers or other table service items with your logo or design. Use personalized drinkware in promotions.

Food storage products can also be personalized to identify menu items, add fill lines for recipes or to add instructions in multiple languages to help ensure product quality and consistency.

 Look for this icon that identifies items that can be personalized.

IMPRINTING TABLE SERVICE AND STORAGE ITEMS

Sample Turnaround Time: 7-10 business days after receipt of approved artwork

Print Area: 6 mm to 10 cm, subject to printable area on each item

Full Case Quantity: No broken cartons

PERSONALIZATION CHARGES (NET)

Sample Charge: *** (Charge will be billed on sample order, credited on first purchase order)

Plate Charge: *** (Billed on sample order, one time charge)

Set-Up Charge: *** (Per order)

Cost Per Imprint: *** (Per side)

HOW TO ORDER A SAMPLE

1. Request a Sample

Contact your local Cambro representative to complete and submit your sample request to Cambro.

2. Provide Artwork

Provide ready to use artwork, digital format only. Completed sample request form must be submitted to Cambro **PRIOR** to artwork being sent. If artwork is incomplete, graphic support services are available at ***per hour.

3. Submit Artwork

E-mail artwork to your Cambro Rep or direct to Cambro at letsgetpersonal@Cambro.com. Title e-mail subject with logo name and provide contact info.

File dimensions: 100% reproduction size, 300dpi resolution.

File type:

Adobe® Illustrator®, Photoshop®.

File format: jpeg, tiff, and eps.

Or mail digital artwork to:

CEL - Attn: C.E.L. Customer Service.

Kelterstrasse 51

72669 Unterensingen, Germany.

4. Questions regarding artwork?

Tel: (49)7022-90-100-0;

Ireland Tel: 1800 509 046;

for UK Tel: 0800 587 0057 or

Fax: (49)7022-90-100-19.

5. Sample Approval

A signed sample approval form must be faxed to Cambro customer service prior to processing any purchase orders. This form is included with each sample.

***Contact your Cambro representative for pricing.



CHOOSE ANY ONE OF THESE STANDARD IMPRINT COLORS

Due to the catalog printing process, the colors shown may not be exact.



Red



Yellow



Light Blue



Dark Blue



Green



Orange



Violet



Black



White



Grey



Gold



Silver

CAMVIEW® PITCHERS

- Made of durable CamView material.
- Lightweight for easy handling.
- Exclusive ice-control contoured lip and pour spout reduce spills.
- Slotted base allows for complete and sanitary drying.

Color: Clear (135). P600CW is also available in Amber (153).

Capacities calculated to rim.

Personalization available. See cresting section for information, ordering and pricing.

PC34CW Stackable Pitcher is covered by the following U.S. Patent D 682,002 S.



STOCK PRODUCTS & COLORS AVAILABLE IN OUR EUROPEAN WAREHOUSE

P320CW, P34CW, P34LCW, P480CW, P600CW, P60CW, PL60CW, PE600CW, P64CW, PC64CW: (135)

P320CW, P480CW and P600CW

An industry standard. Broad base for stability, prevents tipping.



PL60CW

Laguna® pitcher with hammered texture that hides scratches. Pour liquids from front or ice and liquid from sides. Matching tumblers available.



P320CW

CAPACITY: 0,95 L

HEIGHT WITH SPOUT: 17 cm

DIAMETER WITH HANDLE: 14,5 cm

Case Pack: 6



P480CW

CAPACITY: 1,4 L

HEIGHT WITH SPOUT: 20 cm

DIAMETER WITH HANDLE: 16 cm

Case Pack: 6



P600CW

CAPACITY: 1,8 L

HEIGHT WITH SPOUT: 20,5 cm

DIAMETER WITH HANDLE: 17 cm

Case Pack: 6



P60CW

CAPACITY: 1,8 L

HEIGHT WITH SPOUT: 23 cm

DIAMETER WITH HANDLE: 18,5 cm

Case Pack: 6



PL60CW

CAPACITY: 1,8 L

HEIGHT WITH SPOUT: 20 cm

DIAMETER WITH HANDLE: 17 cm

Case Pack: 6

PE600CW

Economy and lightweight design. Pour liquids from front or ice and liquid from sides.



PE600CW

CAPACITY: 1,8 L

HEIGHT WITH SPOUT: 20 cm

DIAMETER WITH HANDLE: 18,7 cm

Case Pack: 6

P64CW

Tapered design and drip-proof spout.



P64CW

CAPACITY: 1,9 L

HEIGHT WITH SPOUT: 23,5 cm

DIAMETER WITH HANDLE: 18,5 cm

Case Pack: 6

PC64CW

Three position lid can strain ice, free pour or close to protect contents.



PC64CW

CAPACITY: 1,9 L

HEIGHT WITH SPOUT: 24,8 cm with lid

DIAMETER WITH HANDLE: 18,5 cm

Case Pack: 6

PC34CW

Stackable pitchers and lid with frosted design to hide scratches.



PC34CW

CAPACITY: 1 L

HEIGHT WITH SPOUT: 19,05 cm with lid

DIAMETER WITH HANDLE: 17 cm

Case Pack: 6

P34CW

Stackable pitcher only.

P34LCW

Stackable pitcher lid only.



P34CW / P34LCW

CAPACITY: 1 L / —

HEIGHT WITH SPOUT: 16,8 cm / 5,11 cm

DIAMETER WITH HANDLE: 17 cm / 11,4 cm

Case Pack: 6

CAMWEAR® ALISO® BARWARE, GOBLETS AND DESSERT GLASS

Aliso Barware replicates the look, heft and clarity of glass with durable Camwear. The smooth seamless appearance makes Aliso Barware a stylish choice for casual dining, outdoor events or for poolside service.

- Barware items have large, heavy bases for stability.
- Bases designed for fast draining and complete drying.
- Chill or frost barware without concerns of thermal shock damage.

Color: Clear (135).

Capacities calculated to rim.

Personalization available. See cresting section for information, ordering and pricing.



CODE	BWM10CW	BWW10CW	BWP14CW	BWB16CW	GB850CW	GB1200CW	DG3CW*
DESCRIPTION	Martini	Wine	Pilsner	Beer mug	Goblet	Goblet	Dessert glass
MAX DIAMETER	12,2 cm	7,5 cm	8,3 cm	12,1 cm	7 cm	7 cm	5,8 cm
MAX HEIGHT	17,5 cm	17,1 cm	24,3 cm	15,9 cm	15,9 cm	19,4 cm	7,7 cm
FULL SIZE CAMRACK®	9S638	25S638	25S958	16S638	36S534	36S738	49S318
CAPACITY TO RIM	310,5 mL	310,5 mL	458,4 mL	473 mL	266 mL	378 mL	100 mL
CASE PACK	12	24	24	12	24	24	72

*Available for ordering in cases only. No broken cartons.

CAMBRO® TUMBLERS AND DISPOSABLE CAMLIDS®

- Disposable lids fit tightly on Cambro tumblers, avoiding spills.
- Lids have tumbler code imprinted on them for easy cross reference.
- Includes a cross slot for straws.
- Reusable tumblers save operators the cost of replacing broken glass or disposable kids' cups while reducing waste.
- Reusable tumblers can be personalized with logos or exclusive designs to enhance branding.

Disposable CamLid Color:
Translucent (190).

Disposable lids are sold in full cases only.
No broken cartons.

*Excludes a cross-slot for straws.

CAMWEAR®
Durable



TUMBLER	LID
950CW	CLNT10
1600CW	CL900P

COLORWARE
Value Tumbler



TUMBLER	LID
500P/500P2	CLJ6
800P	CL800P
900P/900P2	CL900P
950P/950P2	CL950P

DEL MAR®
Crackled Glass Look



TUMBLER	LID
D14	CLST9

LIDO®
Diamond Point Design



TUMBLER	LID
LDT5	CLJ6
LDT6	CLST6
LDT9	CL900P
LDT10	CLNT10
LDT12	CLNT12
LDT16	CLST9
LDT22	CLSM8B5*

HUNTINGTON®
Elegant Design,
Durable



TUMBLER	LID
HT8CW	CLNT8
HT120CW	CLNT12
HT16CW	CLAM8B5*
HT22CW	CLSM8B5*

LAGUNA®
Hammered Texture



TUMBLER	LID
LT6	CLLT6
LT8	CLLT8
LT10	CLLT10
LT12	CLLT12
LT16	CLAM8B5*

NEWPORT
Fluted Design



TUMBLER	LID
NT5	CLNT5
NT8	CLNT8
NT9	CLNT9
NT10	CLNT10
NT12	CLNT12
NT20	CLSM8B5*

LIDO® – SAN TUMBLERS

- Ideal for fast-paced casual dining or outdoor events. Offers the look of glass without the risk.
- Easy to clean internal stacking ring promotes stable and space-efficient storage.
- Prevent spills with tight fitting disposable Camlids®.
- Made of impact resistant SAN plastic that resists chips and breaks, minimizing replacement costs.

Color: Clear (152).

Capacity is to the top fill-line.

Lido Tumblers are covered by U.S. Patent D720,963 S.



*177 and 266 mL tumblers feature subtle graduation markings intended for use in healthcare operations.



CODE	LDT5	LDT6	LDT9	LDT10	LDT12	LDT16	LDT22
FITS LID	CLJ6	CLST6	CL900P	CLNT10	CLNT12	CLST9	CLSM8B5**
DIAMETER	5,9 cm	6,8 cm	8,1 cm	7,3 cm	7,6 cm	8,4 cm	8,9 cm
HEIGHT	9,4 cm	9,4 cm	9,4 cm	11,4 cm	12,5 cm	13,5 cm	16,8 cm
FULL SIZE CAMRACK®	49S318	36S318	25S318	36S418	30S434	25S534	20S638
CAPACITY TO RIM	150 mL	177 mL*	266 mL*	300 mL	355 mL	480 mL	650 mL

Case Pack: 36 **Excludes a cross-slot for straws.

CAMWEAR® HUNTINGTON® & NEWPORT – SAN TUMBLERS

Huntington Tumblers

- Feature the elegant look and feel of glass without the high replacement costs.
- Made of durable Camwear.
- Lightweight.
- Stacking lugs to prevent sticking.
- Three sided drain bottom for easy washing and drying.

Colors: Azure Blue (196), Clear (135).

Capacities calculated to rim.

Personalization available. See crestring section for information and ordering.

Withstands temperatures from -40° to 99°C.



STOCK PRODUCTS & COLORS AVAILABLE IN OUR EUROPEAN WAREHOUSE

HT5CW, HT8CW, HT120CW, HT10CW, HT12CW: (135)



CODE	HT5CW	HT8CW	HT10CW	HT120CW	HT12CW	HT14CW	HT16CW	HT22CW
MAX DIAMETER	6 cm	6,8 cm	7,1 cm	7,6 cm	8,6 cm	8,3 cm	8,4 cm	8,9 cm
MAX HEIGHT	9 cm	11,3 cm	12,2 cm	12,8 cm	9,5 cm	12,4 cm	14 cm	17 cm
FULL SIZE CAMRACK®	49S318	36S418	36S434	25S434	25S418	25S434	25S534	25S638
CAPACITY TO RIM	148 mL	237 mL	296 mL	355 mL	355 mL	414 mL	473 mL	652 mL
CASE PACK	36	36	36	36	36	36	36	36

Newport Tumblers

- Fluted design features the upscale look of glass with the safety benefits and cost savings of plastic.
- Impact resistant SAN plastic resists chips and breaks.
- Stacking lugs prevent sticking.
- Sani-Rim lip provides a sanitary drinking surface.

Colors: Clear (152), Amber (153), Slate Blue (401).

Capacities calculated to rim.

Personalization available. See crestring section for information and ordering.

Withstands temperatures from -20° to 85°C.



STOCK PRODUCTS & COLORS AVAILABLE IN OUR EUROPEAN WAREHOUSE

NT5, NT8, NT9, NT10, NT12: (152)



CODE	NT5	NT8	NT9	NT10	NT12	NT14	NT16	NT20
MAX DIAMETER	6,4 cm	6,8 cm	8,3 cm	7,1 cm	7,6 cm	7,9 cm	8,3 cm	8,7 cm
MAX HEIGHT	9,4 cm	10,2 cm	8,4 cm	11,6 cm	13 cm	12,7 cm	14,6 cm	16,5 cm
FULL SIZE CAMRACK	36S318	36S418	25S318	36S434	25S434	25S434	25S534	25S638
CAPACITY TO RIM	189 mL	228 mL	275 mL	300 mL	373 mL	414 mL	485 mL	650 mL
CASE PACK	36	36	36	36	36	36	36	36

LAGUNA® – SAN & DEL MAR® TUMBLERS

Laguna Tumblers

- Hammered texture hides water spots and scratches.
- Made of impact resistant SAN.
- Lightweight and easy to carry.

Colors: Clear (152), Spanish Green (427).

Capacities calculated to rim.

Personalization available. See creasing section for information, ordering and pricing.

Withstands temperatures from -20° to 85°C.



STOCK PRODUCTS & COLORS AVAILABLE IN OUR EUROPEAN WAREHOUSE

LT8, LT10, LT12, LT22: (152)



CODE	LT6	LT8	LT10	LT12	LT14	LT16	LT22
MAX DIAMETER	6,3 cm	6,9 cm	7,4 cm	7,9 cm	8,3 cm	8,4 cm	9,3 cm
MAX HEIGHT	10,7 cm	10,9 cm	12,1 cm	12,7 cm	13,1 cm	14 cm	15,4 cm
FULL SIZE CAMRACK®	36S418	36S418	30S434	25S434	25S434	25S534	16S534
CAPACITY TO RIM	177,4 mL	236,6 mL	295,7 mL	354,9 mL	414 mL	473,2 mL	650,6 mL
CASE PACK	36	36	36	36	36	36	36

Del Mar Tumblers

- Crackled glass look features the lightweight handling of plastic.
- Thick sturdy base and rolled rim edge for added stability.
- Made of impact resistant SAN plastic.

Colors: Clear (152), Ruby Red (156), Sapphire Blue (608), Light Amber (609).

Capacities calculated to rim.

Personalization available. See creasing section for information, ordering and pricing.

Del Mar Tumblers are covered by the following U.S. Patent D 478,778 S.

Withstands temperatures from -20° to 85°C.



CODE	D8	D12	D14	D16	D24
MAX DIAMETER	6,7 cm	7,5 cm	8,3 cm	7,8 cm	8,7 cm
MAX HEIGHT	10,6 cm	12 cm	8,3 cm	15,1 cm	16,8 cm
FULL SIZE CAMRACK	36S418	25S434	25S318	25S534	25S638
CAPACITY TO RIM	237 mL	355 mL	414 mL	473 mL	710 mL
CASE PACK	36	36	36	36	36

COLORWARE – SAN TUMBLERS & COCA-COLA® TUMBLERS

- A classic value tumbler ideal for casual dining.
- Textured on the outside to resist scratching.
- Made of impact resistant SAN.
- Interior stacking lugs for easy storing.
- Sani-Rim lip provides a sanitary drinking surface.

Colors: Slate Blue (401), Clear (152), Amber (153), Ruby Red (156).

Capacities calculated to rim.

Personalization available. See cresting section for information and ordering.

Withstands temperatures from -20° to 85°C.



STOCK PRODUCTS & COLORS AVAILABLE IN OUR EUROPEAN WAREHOUSE

1200P: (152)



CODE (72 PACK)	500P	800P	900P	950P	1200P	1600P	2000P	—
CODE (24 PACK)	500P2	800P2	900P2	950P2	1200P2	1600P2	2000P2	3200P2
MAX DIAMETER	5,7 cm	6,7 cm	8,1 cm	7 cm	7,5 cm	8 cm	8,6 cm	10 cm
MAX HEIGHT	9,2 cm	10,2 cm	8,25 cm	11,1 cm	13,2 cm	14,6 cm	16,5 cm	18,4 cm
FULL SIZE CAMRACK®	49S318	36S418	25S318	36S418	25S434	25S534	25S638	16S738
CAPACITY TO RIM	154 mL	231 mL	287 mL	290 mL	373 mL	485 mL	650 mL	976 mL
P CODE-CASE PACK	72	72	72	72	72	72	72	—
P2 CODE-CASE PACK	24	24	24	24	24	24	24	24

Coca-Cola® Tumblers

- Colorware Tumblers featuring the Coca-Cola trademark logo in White.
- Available only to Coca-Cola fountain customers for foodservice use.

Color: Clear (152).

Coca-Cola Logo is imprinted in white only.

These trademarked vessels may not be resold at retail and are available only for distribution to Coca-Cola Fountain customers for foodservice use.

Withstands temperatures from -20° to 85°C.



CODE	20CC	32CC
MAX DIAMETER	8,6 cm	10 cm
MAX HEIGHT	16,5 cm	18,4 cm
FULL SIZE CAMRACK	25S638	16S738
CAPACITY TO RIM	650 mL	976 mL
CASE PACK	72	24

CAMWEAR® TUMBLERS AND CAMVIEW® CAMLITERS®

Camwear Tumblers

- The look and feel of glass but made of durable Camwear.
- Textured exterior surface resists scratching.
- Smooth interior promotes easy cleaning.
- Designed with a Sani-Rim lip for sanitary drinking.

Color: Clear (152).

Capacities calculated to rim.

Personalization available. See creasing section for information and ordering.

Withstands temperatures from -40° to 99°C.



STOCK PRODUCTS & COLORS AVAILABLE IN OUR EUROPEAN WAREHOUSE

500CW, 800CW: (152)



CODE	500CW	800CW	850CW	950CW	1200CW	1600CW
MAX DIAMETER	5,7 cm	6,7 cm	8,6 cm	7 cm	7,5 cm	7,9 cm
MAX HEIGHT	9,2 cm	10,2 cm	9,7 cm	11,1 cm	13,2 cm	14,6 cm
FULL SIZE CAMRACK®	49S318	36S418	25S418	36S418	36S434	25S534
CAPACITY TO RIM	160 mL	237 mL	269 mL (heavy wall)	284 mL	384 mL	503 mL
CASE PACK	48	48	48	48	48	48

CamView Camliter Beverage Decanters

- Ideal for serving juice or wine on buffet lines or table side.
- Spill-proof, snap tight flat lids included to protect content from cross contamination.
- Pour Spout Lid available to protect content while allowing free pour.
- Light-weight, dent and scratch resistant.
- Made of impact resistant material.
- NSF Listed- Camliter with Flat Lid.

Color: Clear (135).

Lid Color: White (148).

Personalization available. See creasing section for information and ordering.

Withstands temperatures from -40° to 71°C.

Lids not NSF listed.



CODE	CAPACITY	HEIGHT
Camliters complete with lids: (WW1000L, WW250L)		
WW1500	1,5 L	25,4 cm
WW1000	1	24,8
WW500	0,5	20
WW250	0,25	15,9
Lids		
WW1000LS	(lid w/pour spout for 1,5 L, 1 L, and 0,5 L)	
WW1000L	(lid for 1,5 L, 1 L and 0,5 L)	
WW250L	(lid for 0,25 L)	

Case Pack: 12 Pour Spout Lid must be ordered separately.

STOCK PRODUCTS & COLORS AVAILABLE IN OUR EUROPEAN WAREHOUSE

WW1000, WW500, WW250: (135)
WW1000L, WW1000LS: (148)



BEVERAGE DISPENSER, PAIL WITH BAIL & SWIRL BOWLS®

21 L Beverage Dispenser

- Perfect for mixing and serving concentrated beverages.
- Standard and metric graduations are printed on dispenser.
- Impact resistant polyethylene withstands temperatures from -40° to 70°C.

CODE	CAPACITY
DSPR6	21 L

Case Pack: 1

Color: White (148).

Personalization available. See cresting section for information and ordering.



DSPR6
Capacity: 21 L

Pail with Bail – Poly

- A large, multi-purpose, 21 L pail, ideal for mixing, storing and transporting.
- Durable polyethylene withstands temperatures from -40° to 70°C, and is stain resistant.
- Snap-tight, thumb tab cover sold separately.

CODE	CASE PACK
PWB22	6
RFSC12 (cover)	6

Color: White (148).



All graduations are approximate.

Swirl Bowls

- Ideal for hot or cold side dishes, desserts, dips, or fruit.
- Fits on a plate or stacks in place on a buffet station.
- Available in durable Camwear® or break resistant SAN.

Colors:
SRB5CW and SRB13CW: Clear (135), Black (110), White (148).
SRB5 and SRB13: Clear (152), Black (110), White (148).

Made of (P.E.T.) material.



CLSRB5
Disposable lid not NSF.



STOCK PRODUCTS & COLORS AVAILABLE IN OUR EUROPEAN WAREHOUSE

SRB5CW: (135)



Disposable lid available



SRB13CW

SRB5CW

CODE	CAPACITY	CASE PACK
Camwear®		
SRB5CW	148 mL	24
SRB13CW	384	24
SAN		
SRB5	148	24
SRB13	384	24
Disposable Lid		
CLSRB5	—	1,000

Disposable Lid Color: Clear (152).

CAMWEAR® WINE BUCKETS, PUNCH BOWLS & BUD VASE

Wine Buckets

- Chill and showcase wine or champagne.
- Tough Camwear won't crack or break and is easy to clean.

Color: Clear (135).

Personalization available. See cresting section for information and ordering.



CODE	DIMENSION DIA. x H
WC100CW	20,3 x 23,2 cm
WC100CWNH (w/o handles)	20,3 x 22,9

Case Pack: 1



WC100CW

Pebbled Pedestal Punch Bowls

- Perfect for parties, weddings and receptions.
- Made of durable Camwear.
- Attractive pebbled exterior is scratch resistant and smooth interior is easy to clean.

Color: Pebbled (176).

Capacities are calculated to rim.

Personalization not available.



CODE	INSIDE DIAMETER	APPROX. CAPACITY	CASE PACK
PPB15	38,1 cm	10,6 L	1
PPB18	45,7	19,1	1
PPB23	58,4	37,8	1

Bud Vase

- Ideal for dining rooms, cafeteria tables and patient or room service trays.
- Made of durable Camwear.
- Fill with a fresh rose bud or a colorful faux flower.

Colors: Black (110), Clear (135), White (148).



Black (110)



White (148)



Clear (135)



CODE	DESCRIPTION	CASE PACK
BV6CW	15,24 cm bud vase	12



FOOD PRESENTATION

Deli Crock & Platter

ShowFest® Display Bowls & Trays

Camwear® Bowls

Bell Shaped, Budget & Fiberglass Bowls

Camwear Display Covers & Trays

Crocks & Ladles

Camwear Serving Spoons,
Tongs & High Heat Camtensils®

Lugano® Tongs

Camwear Shakers/Dredges & Condiment Jars



DELI CROCKS & PLATTER

- Prep, store and serve all in one with contemporary style at an economical price.
- Crock and platter are made of SAN, making them impact, stain and chip resistant.
- Ideal for supermarket delis, sandwich shops, buffets and catered events.
- Handled covers are made of crystal clear, virtually unbreakable Camwear®.

Crock and Platter Colors: Clear (152), Black (110), White (148), Red (404).

Crock Cover Color: Clear (135).

Deli Crock are covered by the following U.S. Patents D 504,283 S, D 503,871 S & D 494,419 S. Scalloped Food Service Cover is covered by the following U.S. Patent D 509,705 S.

DCC5, DCC10 are NSF Component.



STOCK PRODUCTS & COLORS AVAILABLE IN OUR EUROPEAN WAREHOUSE

DC5, DC10: (110), (148)

DCC5, DCC10: (135)



Prep, stack, store and serve all in one.



Interstacking saves storage space.



Avoid cross contamination and keep food fresh by using clear cover with handle.



Lid can be used as a riser to provide additional height on the buffet table or in a deli display case.



Cover doubles as a false bottom for presentation and to reduce waste.

Crocks & Platter



CODE	DC5	DC10	DP15
DESCRIPTION	Crock	Crock	Platter
DIMENSIONS W x L x H	17,5 x 26 x 8 cm	26,5 x 33,5 x 8 cm	40 x 30,5 x 5,5 cm
APPROXIMATE CAPACITY	2 L	4,6 L	3,2 L

Case Pack: 6

Covers



CODE	DCC5 fits DC5	DCC10 fits DC10
DIMENSIONS W x L x H	15 x 23,8 x 3,5 cm	24 x 31 x 3,5 cm
APPROXIMATE CAPACITY	0,85 L	1,9 L

Case Pack: 6

SHOWFEST® DISPLAY BOWLS & TRAYS

- Showcase cold deli, buffet and salad bar items.
- Made from SAN for impact, stain, break & chip resistance.
- Variety of shapes & sizes to make the best use of display area.

Colors: Black (110).

Personalization not available.



STOCK PRODUCTS & COLORS AVAILABLE IN OUR EUROPEAN WAREHOUSE

SFG1012, SFG1015, SFG820, SFG1220, SFT1010, SFT1212: (110)



Scalloped Ovals



CODE	SFV1015
DIM. W x L x H	25,4 x 38 x 5 cm
APPROX. CAPACITY	2,8 L

Case Pack: 6

Scalloped Rectangles



CODE	SFR1012
DIM. W x L x H	25,4 x 31,8 x 7,6 cm
APPROX. CAPACITY	4,3 L

Case Pack: 6



Octagonals

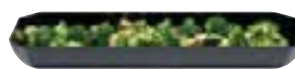

CODE	SFG1012	SFG1015	SFG820	SFG1220
DIM. W x L x H	25,4 x 30,5 x 5 cm	25,4 x 38 x 5 cm	20,3 x 50,8 x 5 cm	30,5 x 50,8 x 5 cm
APPROX. CAPACITY	2,8 L	3,3 L	3,7 L	5,8 L

Case Pack: 6

Triangles



CODE	SFT1010	SFT1212	SFT1515
DIM. W x L x H	25,4 x 30,5 x 6,4 cm	30,5 x 38 x 6,4 cm	38 x 50,8 x 6,4 cm
APPROX. CAPACITY	1,9 L	2,8 L	4,2 L

Case Pack: 6

CAMWEAR® BOWLS

Round Pebbled Bowls

- Textured on the outside for an elegant look, smooth on the inside for easy cleaning.
- Made of virtually unbreakable Camwear for years of dependable service.
- Ideal for fruit, salads, snacks and desserts.

Color: Pebbled (176).

Capacities are calculated to rim.



STOCK PRODUCTS & COLORS AVAILABLE IN OUR EUROPEAN WAREHOUSE

PSB10, PSB12: (176)



Ribbed Bowls

- Stylish, contemporary appearance for a dramatic presentation.
- Made of virtually unbreakable Camwear that won't break like glass.
- Bowls are durable and lightweight. Will not chip and crack like acrylic.
- Resistant to stains, acids and odors.

Colors: Clear (135), Black (110), White (148).

Rectangular Ribbed Bowls are not available in White (148).

Capacities are calculated to rim.



Round Pebbled Bowls



CODE	PSB6	PSB8	PSB10	PSB12
INSIDE DIAMETER	15,2 cm	20,3 cm	25,4 cm	30,5 cm
APPROXIMATE CAPACITY	556 mL	1,5 L	3 L	5,5 L
CASE PACK	12	12	12	12

Round Pebbled Bowls



CODE	PSB15	PSB18	PSB23
INSIDE DIAMETER	38,1 cm	45,7 cm	58,4 cm
APPROXIMATE CAPACITY	10,6 L	19,1 L	37,8 L
CASE PACK	4	4	4

Color: Pebbled (176).

STOCK PRODUCTS & COLORS AVAILABLE IN OUR EUROPEAN WAREHOUSE

PSB15, PSB18: (176)

Rectangular Ribbed Bowls

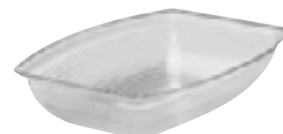

CODE	RSB912CW	RSB1014CW	RSB1419CW
OUTSIDE DIAMETER	22,9 x 30,8 cm	27,3 x 37 cm	36,2 x 49,2 cm
APPROXIMATE CAPACITY	2,7 L	4,7 L	11,3 L
CASE PACK	12	4	4

Rectangular Ribbed Bowls are not available in White (148).

Round Ribbed Bowls



CODE	RSB6CW	RSB8CW	RSB10CW	RSB12CW
INSIDE DIAMETER	15,2 cm	20,3 cm	25,4 cm	30,5 cm
APPROXIMATE CAPACITY	564 mL	1,6 L	3 L	5,5 L
CASE PACK	12	12	12	12



CODE	RSB15CW	RSB18CW	RSB23CW
INSIDE DIAMETER	38,1 cm	45,7 cm	58,1 cm
APPROXIMATE CAPACITY	10,6 L	19,1 L	37,8 L
CASE PACK	4	4	4

BELL SHAPED, BUDGET & FIBERGLASS BOWLS

Camwear® Bell-Shaped Pebbled Bowls

- Perfect for showcasing fruits and salads.
- A versatile alternative to Cambro® traditional Round Pebbled Bowls.
- Made from virtually unbreakable Camwear.

Color: Pebbled (176).

Personalization not available.

Capacities are calculated to rim.



CODE	BSB10	BSB12	BSB18
INSIDE DIAMETER	25 cm	30,5 cm	45,7 cm
APPROX. CAPACITY	2 L	3,8 L	11,8 L
CASE PACK	12	4	4

Budget Salad Bowls

- An economical serving choice for fruit, salads, snacks and desserts.
- Impact resistant FDA approved material resists stains, acids and odors.

Colors: Birch (174), Black (110).

Personalization not available.

Capacities are calculated to rim.



CODE	SB55	SB60	SB80
INSIDE DIAMETER	14,5 cm	15,2 cm	20,3 cm
APPROX. CAPACITY	325 mL	375 mL	925 mL

Case Pack: 72



Fiberglass Bowls

- Combines the look of warm wood grains with the durability of fiberglass.
- Colors won't fade even after years of service and washing.

Color: Dark Basketweave (301).

Personalization not available.

For a swatch of this color and pattern, see Camtray® group section.

Capacities are calculated to rim.



CODE	6F	8F
INSIDE DIAMETER	15,6 cm	20,3 cm
APPROX. CAPACITY	425 mL	925 mL

Case Pack: 12



CAMWEAR® DISPLAY COVERS & TRAYS

- Display covers protect freshness of pastries, breads and desserts.
- Virtually unbreakable Camwear features the upscale look of glass.
- Openings on side or end provide quick and easy access to contents without removing cover.‡

Display Covers

Color: Clear (135).

Personalization available. See cresting section for information and ordering.

*Dimensions include handle(s).
Handle height is 2,06 cm.

Market Trays

Colors: Salmon (149), Yellow (145), Blue (142), Green (140), White (148), Black (110).

Colors NSF listed for food contact: White (148), Blue (142), Green (140).

Display Trays

Colors: Clear (135), Black (110).

Personalization not available.

**Special order item not carried in stock – non-returnable.



Display Trays are stackable.
Refer to Market Tray for information.

STOCK PRODUCTS & COLORS AVAILABLE IN OUR EUROPEAN WAREHOUSE

DT1220CW: (110)
RD1200CW, DD1220ECW, DD1220BECW, DD1220SCW, RD1220CW, RD1220CWH: (135)



RD1220CW



RD1220CWH



RD1200CW



DD1220BECW‡



Display Tray – DT1220CW



Dome with side cut – DD1220SCW‡

CODE	APPROXIMATE DIMENSIONS W x L x H*	DESCRIPTION	CASE PACK
Display Covers			
RD1200CW	30,5 x 30,5 x 20,9 cm	Cake cover	1
DD1220CW	55,6 x 37,5 x 20,3	Dome cover	1
DD1220ECW	55,6 x 37,5 x 20,3	Dome w/end cut	1
DD1220BECW	55,6 x 37,5 x 20,3	Dome w/2 ends cut	1
DD1220SCW	55,6 x 37,5 x 20,3	Dome w/side cut	1
DD1826CW	67,9 x 47,9 x 22,5	Dome cover	1
RD926CW	67,2 x 25,4 x 15,9	Rectangular cover	1
RD1220CW	55,6 x 35,9 x 14,9	Rectangular cover	1
RD1220CWH	55,6 x 35,9 x 12,7	Rectangular w/hinge	1
RD1826CW	67,2 x 47,9 x 15,9	Rectangular cover	1
RD1826CWH	67,9 x 47,6 x 13	Rectangular w/hinge	1
Display Tray – Fits with all 1220 covers			
DT1220CW	32,5 x 53	Tray	1
Market Tray – Fits with all 1826 covers			
1826MT**	65,3 x 45,2 x 2,7	Tray	6

CROCKS & LADLES

Crocks

- Ideal for use with salad bars, on buffet tables or at food stations.
- Resists stains and odors caused by vinegar, salad oils, or mayonnaise.
- Made of high impact FDA accepted material.
- Smooth surface is easy-to-clean.

Solid Color Crock Colors: Black (110), Beige (133), Reddish Brown (195).

Clear Crock Color: Clear (152).

Lid Color: White (148).

Personalization available. See personalization section for details.

*Lids for Solid Color and Clear Crocks are not interchangeable.



STOCK PRODUCTS & COLORS AVAILABLE IN OUR EUROPEAN WAREHOUSE

CCP12: (152)



CODE	HEIGHT	TOP DIAMETER	CUT OUT DIAMETER
Solid Color Crock with Lid			
CP12	13,2 cm	12,9 cm	12,1 cm
CP15	11	16,8	15,7
CP27	17,2	16,8	15,6
Clear Color Crock with Lid			
CCP12	13,7	13,3	12,4
CCP15	11,1	17,2	15,9
CCP27	17,5	17,2	15,7

CODE	CAPACITY	CASE PACK
Solid Color Crocks		
CP12	1,1 L w/Lid	12
CP15	1,4 L w/Lid	6
CP27	2,4 L w/Lid	6

Lids for Solid Color Crocks		
CPL12*	Fits Colored CP12 Crock	12
CPL27*	Fits Colored CP15 & CP27	12

Clear Crocks		
CCP12	1,1 L w/Lid	12
CCP15	1,4 L w/Lid	6
CCP27	2,4 L w/Lid	6

Lids for Clear Crocks		
CCPL12*	Fits Clear CCP12 Crock	12
CCPL27*	Fits Clear CCP15 & CCP27	12

Camwear® Ladles

- Portion control bowls serve the perfect amount of dressing or food ingredient.
- Angled for easy handling.
- Designed with a side rest so ladles don't slip into crocks or serving bowls.
- Made of virtually unbreakable Camwear for years of dependable service.

Colors: Black (110), Beige (133), Clear (135), White (148).

*Cambro®'s assortment pack is available in black only. It offers 8 imprinted ladles and 4 with no imprinting. The 8 imprints include: 1 Thousand Island, 1 French, 1 House, 1 Italian, 1 Bleu Cheese, 1 Ranch, 1 Low Cal, 1 Caesar. This makes a perfect start-up set for a salad bar.

Custom Order Ladle Imprints – See creating section for information and ordering. Maximum imprint area is 2,5 x 1,2 cm. Six dozen minimum.

No broken cartons on assortment pack or imprinted ladles. Special order item not carried in stock, non-returnable.



STOCK PRODUCTS & COLORS AVAILABLE IN OUR EUROPEAN WAREHOUSE

LD85, LD105: (135), (110)



Imprinted Ladles shown.

CODE	DESCRIPTION	LENGTH	CAPACITY
LD85	Plain	21,6 cm	25 mL
LD85A*	Assortment	21,6	25
LD105	Plain	26,8	30
LD105A*	Assortment	26,8	30
LD130	Plain	33	30

Case Pack: 12

CAMWEAR® SERVING SPOONS, TONGS & HIGH HEAT CAMTENSILS®

Serving Spoons

- Made of virtually unbreakable Camwear, spoons won't tarnish, bend or dent.
- A wide handle and molded in thumb rest ensure a solid, ergonomic grip.
- Spoons feature a notched back to rest on pans.
- Spoon capacities are approximate and are not intended for measuring.

Colors: Black (110), Beige (133), Clear (135), Red (404), White (148).

Personalization available. See crestring section for information, ordering and pricing.

*Cannot be personalized.



STOCK PRODUCTS & COLORS AVAILABLE IN OUR EUROPEAN WAREHOUSE

SP011CW, SP013CW, SPOP13CW: (110), (135)
SP08CW, SP010CW, SPOP11CW: (110)



SP010CW PERFORATED

DESCRIPTION: 25,5 cm
Perforated buffet spoon

DIMENSIONS: 26 x 4,3 cm

Case Pack: 12



SPOP11CW* PERFORATED

DESCRIPTION: 28 cm
Perforated deli spoon

DIMENSIONS: 28,3 x 7,3 cm

Case Pack: 12



SPOP13CW* PERFORATED

DESCRIPTION: 33 cm
Perforated deli spoon

DIMENSIONS: 33,3 x 7,3 cm

Case Pack: 12



SP08CW

DESCRIPTION: 20,5 cm
Salad spoon

DIMENSIONS: 20,6 x 3,8 cm

Case Pack: 12



SP010CW

DESCRIPTION: 25,5 cm
Buffet spoon

DIMENSIONS: 26 x 4,3 cm

Case Pack: 12



SP011CW*

DESCRIPTION: 28 cm
Deli spoon

DIMENSIONS: 28,3 x 7,3 cm

Case Pack: 12



SP013CW*

DESCRIPTION: 33 cm
Deli spoon

DIMENSIONS: 33,3 x 7,3 cm

Case Pack: 12

High Heat Camtensils, Spoons and Turners

- Ideal for preparing and serving hot and cold foods.
- Made of a durable high heat material that withstands temperatures from -40° to 149°C.
- Handle includes a hole for hanging when not in use and notches to rest on pans.



SP013

DESCRIPTION: 33 cm
Solid spoon

DIMENSIONS: 33,3 x 7,3 cm

Case Pack: 12



SPA14

DESCRIPTION: 35,5 cm
Solid turner

DIMENSIONS: 35,9 x 8,9 cm

Case Pack: 12



High Heat Spoons and Turners now available in Black.

Colors: Amber (150), Black (110).

Personalization not available.



STOCK PRODUCTS & COLORS AVAILABLE IN OUR EUROPEAN WAREHOUSE

SP013, SPOP13, SPA14: (150)



SPOP13 PERFORATED

DESCRIPTION: 33 cm
Perforated spoon

DIMENSIONS: 33,3 x 7,3 cm

Case Pack: 12



SPASL14 SLOTTED

DESCRIPTION: 35,5 cm
Slotted turner

DIMENSIONS: 35,9 x 8,9 cm

Case Pack: 12



LUGANO® TONGS

- Colored tongs are made from a durable heat resistant material that withstands temperatures up to 100°C.
- Clear tongs are made from virtually unbreakable Camwear, which is safe to 99°C.

FLAT GRIP



TG6
LENGTH: 15 cm
Case Pack: 12



TG9
LENGTH: 23 cm
Case Pack: 12

SCALLOP GRIP



6TGS
LENGTH: 15 cm
Case Pack: 12



9TGS
LENGTH: 23 cm
Case Pack: 12

Colors: Black (110), Beige (133), Clear (135), Red (404), White (148).



STOCK PRODUCTS & COLORS AVAILABLE IN OUR EUROPEAN WAREHOUSE

6TGS, 12TGS, TG6, TG9: (135), (110)
 9TGS: (135), (110), (148)



12TGS
LENGTH: 30,5 cm
Case Pack: 12



Lugano Angled and Easy-Grasp Tongs

- Angled tongs feature an ergonomic design that makes it easy to serve a variety of foods.
- Easy-Grasp Tongs provide a secure grip for hard to hold items.

ANGLED TONG



TGA8
LENGTH: 21 cm
Case Pack: 12



TGA11
LENGTH: 27,5 cm
Case Pack: 12

Angled Tong Color: Black (110).
 Easy-Grasp Colors: Black (110), Beige (133), Clear (135), White (148).

Angled and Easy-Grasp Lugano Tongs are covered under U.S. Patent D 530,994 S.



EASY-GRASP



TGG6
LENGTH: 17 cm
Case Pack: 12



TGG9
LENGTH: 24 cm
Case Pack: 12



CAMWEAR® SHAKERS/DREDGES & CONDIMENT JARS

Camwear Shakers/Dredges

- A staple in the kitchen, at the condiment station or on the dining table.
- Clear virtually unbreakable Camwear and color coded lids make it easy to identify contents.
- Dishwasher safe and unaffected by food acids.

Shaker Color: Clear (135).

Personalization available. See cresting section for information, ordering and pricing.



96SKRLD
Salt & Pepper



96SKRLM
Med. Ground



96SKRLC
Cheese



96SKRLP
Parsley

CODE

LID COLOR

Shakers complete with lids (approx. capacity 300 mL)

96SKRP (w/parsley lid)	White (148)
96SKRD (w/salt & pepper lid)	Beige (406)
96SKRC (w/cheese lid)	Yellow (405)
96SKRM (w/medium ground lid)	Rose (408)

Shaker Replacement Lids (Shaker Lids are not interchangeable with Camliter® Lids)

96SKRLP parsley lid	White (148)
96SKRLD salt & pepper lid	Beige (406)
96SKRLC cheese lid	Yellow (405)
96SKRLM medium ground lid	Rose (408)

Case Pack: 12

Camwear Condiment Jar

- Use to hold condiments such as mustard, ketchup, dressings, jam or salsa.
- Made of clear, virtually unbreakable Camwear.
- Lids are slotted to hold serving spoons when not in use.

Color: Clear (135).

Personalization available. See cresting section for information, ordering and pricing.



CODE	APPROXIMATE CAPACITY	SIZE H x D	CASE PACK
Condiment Jar Set			
CJ80CW	240 mL	10,2 x 8,3 cm	24

TRAYS

Tray Product Guide

Personalization

Polyester Versa Trays

Antimicrobial Camguard® Versa Trays

Polyester Decorated Versa Trays

Polyester Versa Lite Trays

Century™ Fun Trays

Camtrays®

Non-Slip Versa Camtrays®

Dietary and Camlite® Trays

Camwear® Trays

Camtread® / Treadlite™ / Polytread Trays

Epictread™ Trays

Wood Trays

Corfu / Mykonos / Capri / Madeira

Laminated Trays

Fast Food Trays

Compartment Trays

Market Trays



CHOOSE THE RIGHT TRAY FOR YOUR BUSINESS

Cambro is the global leader in manufacturing trays for the food service industry, offering the largest selection of materials, sizes, colors, shapes and personalization processes. Cambro's breadth of assortment provides the clear choice for the right tray for every need and budget.

Consider the following to select the right tray for your operation:

Step 1: What Will the Tray Be Used For?

In order to choose the correct tray, first identify the correct application.

Service Tray

Used by employees to carry items to serve to guests:

Non-Slip Tray

Patron Tray

Used by customers to carry menu items:

Smooth Surface Tray

Step 2: Who Will Be Using the Tray?

To determine the appropriate tray material, it is critical to identify who will be using the tray.

Children

Students

Military

Office Employees

Wait Staff

Step 3: How Will the Tray Be Used and Washed?

Consider how the tray will be used, and whether it will endure mild or excessive use and abuse. Determine how often the trays will be washed per day.

Extensive:

Wash as often and as frequently as needed

Normal:

Wash up to 3 times per day

Minimal:

Wash once per day

Step 4: Determine the Budget per Tray

Ensure that the correct tray has been selected for the right application. Selecting a low cost tray for a heavy application is not the most cost effective option. Tray pricing varies according to the following factors:

Manufacturing process

Material type and grade

Tray size

Personalization options

Warranty

Step 5: Personalization

Cambro offers high quality personalization on most of the trays that we manufacture. Look for the personalization logo throughout the brochure. 

Step 6: Additional Features to Consider

Evaluate the importance of the following features to determine the best tray for your operation.

Stacking lugs - Promote air circulation for fast drying and perfect stacking

Surface impact resistance

Edge breaking resistance

Scratch and stain resistance

Type of Warranty

Technical test descriptions

All Cambro trays are submitted to an array of tests described to the right. The results are indicated on each tray page under Technical Test Results.



Versa Trays



Versa Trays Anitmicrobial



Versa Lite Trays



Laminated Capri Trays



Laminated Corfu Trays



Laminated Mykonos Trays



Fast Food Trays



Non-Slip Trays

TESTS DESCRIPTIONS

Thermal Shock Resistance Test:

Test consists of applying a radical temperature change during a short period of time to the tray, by taking out the tray from icy water (0°C) and placing it into boiling water (100°C) and measuring any deformation.

Break Resistance Test:

Test consists of dropping a metal ball from specific heights onto the tray and measuring any deformation.

Scratch Resistance Test:

Observe scratches and abrasions as a result of friction between porcelain dinnerware and the tray surface.

Test consists of moving a porcelain dish placed on tray from left to right under hand pressure and measuring any abrasion on tray surface.

DISHWASHER SAFE DESCRIPTIONS

Extensive: Wash as often and as frequently as needed.

Normal: Wash up to 3 times per day.

Minimal: Wash once per day.

TRAY PRODUCT GUIDE

POLYESTER TRAYS



RECOMMENDED USE



TRAY DESCRIPTION

Versa Trays
Ecologic Series
Page 206

Versa Tray Plus
Page 207

Antimicrobial
Versa Trays VT/GP
Page 208

Versa Trays with
Décor GP
Page 209

Versa Trays with
Non-Slip Surface GP
Page 209

TRAY DESCRIPTION	Versa Trays Ecologic Series Page 206	Versa Tray Plus Page 207	Antimicrobial Versa Trays VT/GP Page 208	Versa Trays with Décor GP Page 209	Versa Trays with Non-Slip Surface GP Page 209
MATERIAL	Natural Material + SMC-High Performance Fiberglass Reinforced Polyester	SMC-High Performance Fiberglass Reinforced Polyester	SMC-High Performance Fiberglass Reinforced Polyester	SMC-High Performance Fiberglass Reinforced Polyester + Melamine Surface	SMC-High Performance Fiberglass Reinforced Polyester + Non-Slip Surface
SURFACE	Smooth	Smooth	Smooth	Smooth	Non-Slip
PERFORMANCE	Excellent	Excellent	Excellent	Excellent	Excellent
PERSONALIZATION	Yes Δ Heat resistance: 90°C	No	No	No	Yes Δ Heat resistance: 80°C
YEARS WARRANTIED**	5	5	5	5	2
STACKING LUGS*	Yes	Yes	Yes	Yes	Yes
DISHWASHER SAFE	Yes – Extensive	Yes – Extensive	Yes – Extensive	Yes – Extensive	Yes – Extensive
CHEMICAL RESISTANCE	Excellent	Excellent	Excellent	Excellent	Good
DRYING TEST	Excellent	Excellent	Excellent	Excellent	Excellent
THERMAL SHOCK RESISTANCE	Excellent	Excellent	Excellent	Excellent	Excellent
BREAK RESISTANCE	Excellent	Excellent	Excellent	Excellent	Excellent
SCRATCH RESISTANCE	Excellent	Excellent	Excellent	Excellent	Good
STAIN RESISTANCE	Excellent	Excellent	Excellent	Excellent	Good
HEAT RESISTANCE	-40° to +140°C ‡	-40° to +140°C ‡	-40° to +140°C ‡	-40° to +90°C ‡	-40° to +80°C ‡
NUMBER OF SIZES	5	5	6	3	4
NUMBER OF SHAPES	4	4	3	1	1
NUMBER OF COLORS	4	3	1	15	5

*Stacking lugs allow free air circulation and perfect stacking.

**Prorated warranty against manufacturer's defects.

‡Not recommended for heated cart.

ΔContact your Cambro representative for pricing.

If you are using Thermo-Chemical Disinfection Equipment, please contact us. We will assist you finding the right tray for your application.

Icon Directory for Recommended Use:



Canteens /
Cafeterias /
Self-serve



Catering /
Banquet Service



Deli /
Buffet displays



Educational



Food courts /
Snack shops /
Quick serve



Home meal delivery



Hospitals



Hotel /
Room service



Military



Prisons /
Corrections























Restaurants /Cafes /
Brasseries /
Pubs / Bars / Clubs

TRAY PRODUCT GUIDE

POLYESTER TRAYS



RECOMMENDED USE	   	     	   	    	 
TRAY DESCRIPTION	Versa Trays VT/GP Pages 210-211	Versa Lite Trays VL/GL Pages 212-213	Century™ Fun Trays: Versa Trays VT/GP Versa Lite Trays VL/GL Page 214-215	Non-Slip Versa Lite Trays VL/GL Page 216	Versa Lite Trays with Non-Slip Rubber Surface VL/GL Page 217
MATERIAL	SMC-High Performance Fiberglass Reinforced Polyester	SMC-Standard Performance Fiberglass Reinforced Polyester	SMC-High or Standard Performance Fiberglass Reinforced Polyester	SMC-Standard Performance Fiberglass Reinforced Polyester + Non-Slip Surface	SMC-Standard Performance Fiberglass Reinforced Polyester + Non-Slip Rubber Surface
SURFACE	Smooth	Smooth	Smooth	Non-Slip	Non-Slip Rubber
PERFORMANCE	Excellent	Excellent	Excellent	Excellent	Excellent
PERSONALIZATION	Yes Δ Heat resistance: 90°C	Yes Δ Heat resistance: 90°C	Yes Δ Heat resistance: 90°C	Yes Δ Heat resistance: 80°C	No
YEARS WARRANTIED**	5	3	3	2	3
STACKING LUGS*	Yes	Yes	Yes	Yes	Yes
DISHWASHER SAFE	Yes – Extensive	Yes – Normal	Yes – Normal	Yes – Normal	Yes – Normal
CHEMICAL RESISTANCE	Excellent	Good	Good	Good	Good
DRYING TEST	Excellent	Excellent	Excellent	Excellent	Excellent
THERMAL SHOCK RESISTANCE	Excellent	Good	Good	Good	Good
BREAK RESISTANCE	Excellent	Good	Good	Good	Good
SCRATCH RESISTANCE	Excellent	Good	Good	Good	Good
STAIN RESISTANCE	Excellent	Good	Good	Good	Good
HEAT RESISTANCE	-40° to +140°C ‡	-40° to +130°C ‡	-40° to +90°C ‡	-40° to +80°C ‡	-40° to +100°C ‡
NUMBER OF SIZES	22	14	1	4	7
NUMBER OF SHAPES	9	6	1	3	3
NUMBER OF COLORS	12	8	14	4	2

*Stacking lugs allow free air circulation and perfect stacking.

**Prorated warranty against manufacturer's defects.

‡Not recommended for heated cart.

ΔContact your Cambro representative for pricing.

If you are using Thermo-Chemical Disinfection Equipment, please contact us. We will assist you finding the right tray for your application.

POLYESTER TRAYS

- Versa Tray Ecologic Series
- Versa Tray Plus
- Versa Tray Antimicrobial
- Versa Trays
- Versa Trays with Décor (1)
- Versa Non-Slip Versa Trays
- Versa Century Fun

High performance polyester trays are made of rugged reinforced mat with long fibers and additional fiberglass to provide extremely high shock-resistance. Colored isophthalic polyester resin offers high chemical and UV-resistance.

(1) Personalized Versa Trays and Versa Trays with Décor have a Melamine Resin Layer on top increasing protection against stains, abrasions and scratches.

VERSA LITE TRAYS

- VL/GL Century Fun
- VL/GL Trays
- VL/GL Trays with Non-Slip Surface
- VL/GL Trays with Non-Slip Rubber Surface

Standard performance polyester trays are made of fiberglass and standard polyester resin.



Canteens /
Cafeterias /
Self-serve



Catering /
Banquet Service



Educational



Hospitals



Hotel /
Room service



Military



Restaurants /Cafes /
Brasseries /
Pubs / Bars / Clubs

TRAY PRODUCT GUIDE

FIBERGLASS TRAYS

CAMWEAR® TRAYS



RECOMMENDED USE



TRAY DESCRIPTION

Camtray®
Pages 218-222

**Non-Slip
Versa Camtrays**
Page 223

Dietary Trays
Page 224

Camlite® Trays
Page 224

Camwear Trays
Page 225

**Camwear Trays with
Non-Slip Surface**
Page 225

MATERIAL	Fiberglass Layers + Polyester Resin	Fiberglass Layers + Polyester Resin + Non-Slip Surface	Fiberglass Layers + Polyester Resin	Fiberglass Layers + Polyester Resin	Camwear	Camwear + Non-Slip Surface
SURFACE	Smooth	Non-Slip	Smooth	Smooth	Textured	Non-Slip
PERFORMANCE	Excellent	Excellent	Excellent	Excellent	Excellent	Excellent
PERSONALIZATION	Yes Δ Heat resistance: 100°C	Yes Δ Heat resistance: 80°C	No	No	No	No
YEARS WARRANTIED**	5	2	1	3	3	3
STACKING LUGS*	Yes	Yes	Yes	Yes	Yes	Yes
DISHWASHER SAFE	Yes – Extensive	Yes – Extensive	Yes – Extensive	Yes – Extensive	Yes – Extensive	Yes – Extensive
CHEMICAL RESISTANCE	Good	Good	Good	Good	Good	Good
DRYING TEST	Excellent	Excellent	Excellent	Excellent	Excellent	Excellent
THERMAL SHOCK RESISTANCE	Excellent	Excellent	Excellent	Excellent	Excellent	Excellent
BREAK RESISTANCE	Excellent	Excellent	Good	Good	Excellent	Excellent
SCRATCH RESISTANCE	Excellent	Good	Good	Good	Very Good	Good
STAIN RESISTANCE	Excellent	Good	Excellent	Excellent	Very Good	Good
HEAT RESISTANCE	-10° to +100°C ‡	-40° to +80°C ‡	-10° to +100°C ‡	-10° to +100°C ‡	-40° to +99°C ‡	-40° to +82°C ‡
NUMBER OF SIZES	40	2	6	6	2	2
NUMBER OF SHAPES	7	2	1	2	3	2
NUMBER OF COLORS	52	3	52	9	2	2

*Stacking lugs promote air circulation and perfect stacking.

**Prorated warranty against manufacturer's defects.

Δ Contact your Cambro representative for pricing.

‡Not recommended for heated cart.

FIBERGLASS TRAYS

- Camtray
- Non-Slip Versa Camtray
- Dietary Trays
- Camlite Trays

Made of rugged fiberglass interior to provide a tough inner foundation and smooth surface, coupled with polyester resin to resist impact and stains.

CAMWEAR TRAYS

- Camwear Trays
- Made of highly durable, virtually unbreakable Camwear.

- Camwear Trays with Non-Slip Surface

Made of highly durable, virtually unbreakable Camwear. The non-slip, clear textured, surface is scratch resistant.



Canteens /
Cafeterias /
Self-serve



Educational



Food courts /
Snack shops /
Quick serve



Hospitals



Hotel /
Room service



Military



Restaurants /Cafes /
Brasseries /
Pubs / Bars / Clubs

TRAY PRODUCT GUIDE

	FIBERGLASS TRAYS	POLYPROPYLENE	FIBERGLASS TRAYS	WOOD TRAYS	
					
RECOMMENDED USE	 		 	  	 
TRAY DESCRIPTION	Camtread® Trays Page 226	Treadlite™ Trays Page 227	Polytreed® Trays Page 227	EpicTread™ Trays Page 228	Wood Trays with Non-Slip Surface Pages 228
MATERIAL	Fiberglass Layers + Polyester Resin + Non-Slip Rubber Surface	Fiberglass Layers + Polyester Resin + Non-Slip Rubber Surface	Polypropylene + Non-Slip Rubber Surface	Fiberglass Layers + Non-Slip, Water Repellent Surface	Veneer Beechwood or Mahogany + Non-Slip Surface
SURFACE	Non-Slip Rubber	Non-Slip Rubber	Non-Slip Rubber	Non-Slip	Non-Slip
PERFORMANCE	Excellent	Good	Good	Good	Good
PERSONALIZATION	Yes Δ	No	No	Yes Δ Heat resistance: 90°C	Yes
YEARS WARRANTIED**	5	1	1	2	3
STACKING LUGS*	Yes	Yes	Yes	Yes	No
DISHWASHER SAFE	Yes – Extensive	Yes – Extensive	Yes – Minimal	Yes – Minimal	Yes – Minimal
CHEMICAL RESISTANCE	Good	Good	Good	Good	Good
DRYING TEST	Excellent	Good	Good	Good	Good
THERMAL SHOCK RESISTANCE	Excellent	Good	Good	Good	Good
BREAK RESISTANCE	Good	Good	Good	Good	Good
SCRATCH RESISTANCE	Excellent	Good	Good	Good	Good
STAIN RESISTANCE	Good	Good	Good	Good	Good
HEAT RESISTANCE	-10° to +100°C ‡	-10° to +80°C ‡	-10° to +80°C ‡	-10° to +90°C ‡	-10° to +100°C ‡
NUMBER OF SIZES	16	2	6	2	7
NUMBER OF SHAPES	5	1	2	1	3
NUMBER OF COLORS	2	2	2	6	1

*Stacking lugs promote air circulation and perfect stacking.

**Prorated warranty against manufacturer's defects.

ΔContact your Cambro representative for pricing.

‡Not recommended for heated cart.

FIBERGLASS TRAYS

- Camtread Trays
- Treadlite Trays
- EpicTread Trays

Made of rugged fiberglass interior to provide a tough inner foundation and smooth surface, coupled with polyester resin to resist impact and stains.



Catering /
Banquet Service



Hotel /
Room service



Restaurants /Cafes /
Brasseries /
Pubs / Bars / Clubs

POLYPROPYLENE TRAYS

- Polytreed Trays

Polytreed trays have non-slip rubber surface bonded directly into the tray.

TRAY PRODUCT GUIDE

WOOD TRAYS

LAMINATED TRAYS



RECOMMENDED USE



TRAY DESCRIPTION	Wood Trays with Smooth Surface Page 229	Corfu Laminated Trays with Non-Slip Rubber Surface Page 230	Mykonos Laminated Trays with Non-Slip Surface Page 231	Capri Laminated Trays with Smooth Surface Pages 232-233	Madeira Laminated Trays with Textured Wood Surface Page 234
MATERIAL	Veneer Beechwood	Laminate + Non-Slip Rubber Surface	Laminate + Non-Slip Surface	Laminate	Laminate
SURFACE	Smooth	Non-Slip Rubber	Non-Slip	Smooth	Textured
PERFORMANCE	Good	Excellent	Good	Good	Good
PERSONALIZATION	No	Yes†	Yes	Yes	No
YEARS WARRANTIED**	3	3	3	3	3
STACKING LUGS*	No	No	No	No	No
DISHWASHER SAFE	Yes – Normal	Yes – Normal	Yes – Minimal	Yes – Normal	Yes – Normal
CHEMICAL RESISTANCE	Excellent	Excellent	Good	Excellent	Excellent
DRYING TEST	Good	Good	Good	Good	Good
THERMAL SHOCK RESISTANCE	Good	Good	Good	Good	Good
BREAK RESISTANCE	Good	Good	Good	Good	Good
SCRATCH RESISTANCE	Good	Good	Good	Good	Good
STAIN RESISTANCE	Good	Good	Good***	Excellent	Excellent
HEAT RESISTANCE	-10° to +100°C ‡	-10° to +100°C ‡	-10° to +100°C ‡	-10° to +100°C ‡	-10° to +100°C ‡
NUMBER OF SIZES	14	8	15	22	10
NUMBER OF SHAPES	4	2	3	5	4
NUMBER OF COLORS	1	2	6	14	9

*Stacking lugs allow free air circulation and perfect stacking.

**Prorated warranty against manufacturer's defects.

***Limited stain resistance for Birch (E75).

‡Not recommended for heated cart.

†Only back side of Corfu trays can be personalized.

LAMINATED TRAYS

- Smooth Surface
- Clear Non-Slip Surface

Made of several layers of genuine beechwood veneer / mahogany combined with synthetic resin

molded under high pressure and temperature. The surface is sealed with a double layer of high pressure melamine to allow regular washing.

LAMINATED TRAYS

- Corfu*
- Capri
- Mykonos
- Madeira

Made of compressed layers of melamine saturated paper combined with synthetic resin molded under high pressure and temperature.

The surface is sealed with a double layer of high pressure melamine to allow regular washing.

* Laminated trays have a non-slip rubber surface bonded directly into the tray.

Note: All laminated trays must be dried before stacking.



Canteens /
Cafeterias /
Self-serve



Catering /
Banquet Service



















Hotel /
Room service



Restaurants /Cafes /
Brasseries /
Pubs / Bars / Clubs

TRAY PRODUCT GUIDE

	POLYPROPYLENE	COMPARTMENT TRAYS			DISPLAY TRAYS	
						
RECOMMENDED USE		  	  		  	
TRAY DESCRIPTION	Fast Food Trays Page 235	Camwear® Trays Pages 236-238	ABS Page 236	Heat Resistant Trays Page 239	Co-Polymer Trays Pages 240	Market Trays Page 240
MATERIAL	Polypropylene	Camwear	ABS	Heat Resistant Plastic	Co-Polymer	Fiberglass Layers + Polyester Resin
SURFACE	Textured	Textured	Textured	Textured	Textured	Smooth
PERFORMANCE	Good	Excellent	Excellent	Excellent	Excellent	Excellent
PERSONALIZATION	Yes Δ Heat Resistance: 80°C	No	No	No	No	No
YEARS WARRANTIED**	3	3	2	2	2	3
STACKING LUGS*	Yes	Yes	Yes	Yes	Yes	Yes
DISHWASHER SAFE	Yes – Minimal	Yes – Extensive	Yes – Extensive	Yes – Extensive	Yes – Minimal	Yes – Extensive
CHEMICAL RESISTANCE	Excellent	Good	Excellent	Very Good	Excellent	Good
DRYING TEST	Good	Excellent	Excellent	Very Good	Excellent	Excellent
THERMAL SHOCK RESISTANCE	Good	Excellent	Good	Very Good	Good	Excellent
BREAK RESISTANCE	Good	Excellent	Good	Very Good	Good	Good
SCRATCH RESISTANCE	Good	Very Good	Very Good	Very Good	Very Good	Good
STAIN RESISTANCE	Good	Very Good	Very Good	Very Good	Very Good	Excellent
HEAT RESISTANCE	-10° to +80°C ‡	-40° to +99°C ‡	-10° to +82°C ‡	-40° to +149°C	-10° to +80°C ‡	-10° to +100°C ‡
NUMBER OF SIZES	4	8	1	1	8	19
NUMBER OF SHAPES	2	7	1	1	8	2
NUMBER OF COLORS	14	10***	6	1	7	5

*Stacking lugs promote air circulation and perfect stacking.

**Prorated warranty against manufacturer's defects.

***Not available for all tray styles.

Δ Contact your Cambro representative for pricing.

‡Not recommended for heated cart.

POLYPROPYLENE TRAYS

– Fast Food Trays

Fast food trays have a textured surface to hide scratches and provides an additional grip to prevent slipping.

COMPARTMENT TRAYS

– Camwear Trays

Made of highly durable, virtually unbreakable Camwear.

– ABS Trays

Made of high impact resistance and heat and chemical resistance ABS.

DISPLAY TRAYS

– Market Trays

Made of high-impact resistant fiberglass that resists odors.



Deli / Buffet displays



Educational



Food courts / Snack shops / Quick serve



Home meal delivery



Military



Prisons / Corrections

PERSONALIZATION

Value Added Personalization

Promote business to customers and employees alike by placing your custom logo, trademark, slogan or design on our trays.

How to Order

- 1) Select a tray size, color, pattern, or design.
- 2) Provide complete, camera-ready artwork and indicate positioning on the tray.
- 3) According to the tray type, Cambro can produce 1, 2, 3 and 4 color artwork as well as 4 color process artwork.

We require the following:

- a. Electronic artwork file provided on CD-ROM for Mac or PC.

We accept the following file formats:

- Adobe Illustrator, Adobe Photoshop files in JPEG, TIFF or EPS formats.
- File dimensions must equal 100% of reproduction size at 300dpi resolution.

- b. Illustration on paper: The quality of the art must be crisp and scannable. Please specify PANTONE number for each color or indicate if it is a four color process.

- 4) An artist's fee of *** per hour will be charged to any order submitted

without complete, camera-ready artwork. Cambro will contact you if this fee will be charged and will give you an estimated cost.

5) Sample process:

- a. For any new project, a finished sample will be submitted for the customer's approval.
- b. The first sample with a firm purchase order is free. (Plus shipping cost.)
- c. Samples not accompanied by a firm purchase order or requests for more than one sample will be charged a flat rate of:
 - Polyester, Fiberglass and Laminated

Trays:

*** Net per sample. (Plus shipping cost.)

– Polypropylene Fast Food Trays: *** Net per sample. (Plus shipping cost.)

d. Upon receipt and shipment of a firm purchase order, a credit will be applied to your account for the cost of one sample.

6) Personalization charges apply to both original orders and returns.

POLYESTER TRAYS

Versa Trays VT/GP

Versa Lite Trays VL/GL

- Only the following tray models are suitable for personalization:

Versa Trays:

VT1216, VT1418, VT2632, VT3253, VT3343, VT3343C, VT3646C, VT3753, VT3853, GP0540, GP1070, GP1080, GP3074, GP3980, GP4002, GP4210, GP4004, GP4701, GP4709, GP4853

Versa Lite Trays:

VL1014, VL1216, VL1418, VL2632, VL3253, VL3343, VL3343C, VL3646C, VL3753, GL0540, GL1070, GL1080, GL3074, GL3980, GL4002, GL4210, GL4701, GL4709

- **Minimum Quantity:** 120 trays per size.
- **Sample Production Time:** 10 business days + delivery and transit time from receipt of camera ready artwork.
- **Order Production Time:** Up to 4-6 weeks + delivery and transit time from the date artwork is approved and the order is confirmed.
- Request for additional samples without a firm purchase order will be charged *** Net per sample. (Plus shipping cost.)

Printing Process Applicable:

Four Color Printing Process allows printing of one color or multiple color artwork as well as photo reproduction.

Tray Colors Recommended for Personalized Versa Trays VT/GP:

Speckled Mocha (A21), Sahara (A22), Light Grey (A27), Pearl White (A33), Terrazzo (A86).

For the following colors, please call Cambro Customer Service for artwork review: Magic Yellow (A25), Magic Mint (A26).

Tray Colors Recommended for Personalized Versa Lite Trays VL/GL:

Speckled Smoke (A20), Speckled Mocha (A21), Sahara (A22), Light Grey (A27), Pearl White (A33) and Terrazzo (A86).

Printable Area:

The artwork can cover the flat surface of tray up to 1 cm from the internal tray edge.

Personalization Charges Per Tray:

QUANTITY EACH	ADDITIONAL NET CHARGES
120-300	***
312-996	***
1,008 and up	***

***Contact your Cambro representative for pricing.



FIBERGLASS TRAYS

Camtray® Trays

- All Camtray sizes can be personalized. (Except compartment trays shown in main Cambro catalog).

• Minimum Quantity:

Screen Printing Process: 144 trays per size.
Four Color Printing Process: 72 trays per size.

- **Sample Production Time:** 10 business days + delivery and transit time from receipt of camera ready artwork.

- **Order Production Time:** Up to 4-6 weeks + delivery and transit time from the date artwork is approved and the order is confirmed.

- Request for additional samples without a firm purchase order will be charged *** Net per sample. (Plus shipping cost.)

Printing Process Applicable: Screen printing process and four color process.

a. Screen printing process allows printing of artwork with one or multiple colors laying next to each other. This process doesn't allow printing of gradient or photo reproduction. This process is best used with light color artwork on dark tray color.

Printable area: The artwork can cover the total surface of the tray from one edge to the other.

b. Four Color Printing Process allows printing of one color or multiple color artwork as well as photo reproduction. This process can only be used on light color trays. Darker tray color will make the artwork colors go darker.

Tray Colors Recommended for Four Color Printing Process:

Antique Parchment (101), Light Peach (106), Dark Peach (117), White (148), Sky Blue (177), Key Lime (429), Lemon Chiffon (536), Cameo Yellow (537), Cottage White (538).

Printable area: The artwork can cover the flat surface of tray up to 1 cm from the internal tray edge.

Personalization Charges Per Tray:

QUANTITY EACH	ADDITIONAL NET CHARGES
144*-299**	***
300 and up	Free

*Minimum quantity for four color printing process.

**Minimum quantity for screen printing process.

***Contact your Cambro representative for pricing.



1418

PERSONALIZATION

LAMINATED TRAYS

Corfu, Capri, Mykonos, Madeira

- All Laminated tray sizes can be personalized or produced in any custom color. Custom color matching is treated as a personalization.
- Top and bottom parts of trays can be personalized with the exception of Corfu trays that can only be personalized on the backside of the tray. Personalization cost is per side of the tray.
- **Minimum Quantity:** 120 trays per size.



- **Sample Production Time:** 10 business days + delivery and transit time from receipt of camera ready artwork.
- **Order Production Time:** Up to 4-6 weeks + delivery and transit time from the date artwork is approved and the order is confirmed.

- Request for additional samples without a firm purchase order will be charged *** Net per sample. (Plus shipping cost.)

Printing Process Applicable: Four color process and Custom Color Matching.

a. Four Color Printing Process. This process allows the printing of one color or multiple color artwork as well as photo reproduction.

b. Custom Color Matching: Custom color matching is treated as a personalization. To produce any color tray provide Cambro with PANTONE number.

Printable area: The artwork can cover the total surface of tray from one edge to the other. Artwork dimensions must be 4 cm bigger than tray sizes on each side due to trimming. (example: Tray size: 36 x 46 cm – Artwork size: 40 x 50 cm)

Personalization Charges Per Tray:

QUANTITY EACH	ADDITIONAL NET CHARGES
120 and up	***

***Contact your Cambro representative for pricing.

POLYPROPYLENE TRAYS

Fast Food Trays

- All Fast Food tray sizes can be personalized except 1217FFH.
- **Minimum Quantity:** 288 trays per size.
- **Sample Production Time:** 10 business days + delivery and transit time from receipt of camera ready artwork.
- **Order Production Time:** Up to 4-6 weeks + delivery and transit time



from the date artwork is approved and the order is confirmed.

- Request for additional samples without a firm purchase order will be charged *** Net per sample. (Plus shipping cost.)

Printing Process Applicable:

Hot stamp 1 color process. Due to the application process onto textured tray surface, white can be selected but is not recommended.

Printable area: Artwork cannot exceed a maximum size of 15 x 15 cm.

Personalization Cost:

One-time die charge: *** Net per order

Additional Net Charges Per Tray:

QUANTITY EACH	ADDITIONAL NET CHARGES
288-767	***
768-1,199	***
1,200-5,999	***
6,000-11,999	***
12,000 and up	***

***Contact your Cambro representative for pricing.

CAMTREAD TRAYS

Tray Back Personalization and Rubber Surface Embossing

- **Camtread From USA:** Tray Back Personalization only on 1600CT. Rubber surface embossing all Camtread sizes.
- **Camtread From Europe:** Sizes Available: 1100CT, 1400CT, 1600CT and 1800CT.
- **Sample Production Time:** 10 business days + delivery and transit time from receipt of camera ready artwork.
- **Order Production Time:** Up to 4-6 weeks + delivery and transit time from the date artwork is approved and the order is confirmed.

- Request for additional samples without a firm purchase order will be charged *** Net per sample. (Plus shipping cost.)

Tray Back Personalization Printing Process Applicable:

Four Color Printing Process allows printing of one color or multiple color artwork as well as photo reproduction.

Camtread From USA: White trays are recommended for tray back personalization.

Printable area: The artwork can cover the flat surface of tray up to 2,54 cm from the external tray edge.

Personalization Charges Per Tray:

QUANTITY EACH	ADDITIONAL NET CHARGES
Camtread From USA	
72-144	***
145-288	***
289-432	***
433 and up	Free
Camtread From Europe	
120 and up	***

Rubber Surface Embossing

- **Electronic File Format:** Adobe Illustrator EPS formats.

Embossing Process Printable Area: The artwork can cover the surface of the tray up to 2,54 cm from the internal tray of edge.

Embossing Personalization Charge Per Tray:

QUANTITY EACH	ADDITIONAL NET CHARGES
Camtread From USA	
72 and up	***
Camtread From Europe	
156 and up	***

***Contact your Cambro representative for pricing.

POLYESTER VERSA TRAYS – ECOLOGIC SERIES

SPECIFICATIONS

Material	Natural material + polyester
Surface Characteristic	Smooth
Performance	Excellent
Stacking Lugs	Yes
Dishwasher Safe	Yes – Extensive
Chemical Resistance	Excellent
Drying Test	Excellent
Shock Resistance	Excellent
Break Resistance	Excellent
Scratch Resistance	Excellent
Stain Resistance	Excellent
Heat Resistance	-40° to +140°C‡



‡Not for use in heated carts.

RECOMMENDED USE

High Traffic / Frequent Use

- Hospitals
- Schools
- Universities
- Canteens / Cafeterias / Self-Serve
- Military

Only available from Cambro European Logistics (CEL), Germany and Cambro Özay Turkey.

Minimum quantity order from CEL:

Non-stock item 240 pieces.
No broken carton.



High Profile Shape

Low Profile Shape



Low Profile Design Shape

Flat Edge Shape

Made with resin derived from natural materials.

High performance polyester tray with reinforced corners and edges for superior protection against impact.



GPE4002

Average 20% lighter weight than the standard Versa Tray. Makes handling easy and convenient.

Stacking lugs keep trays stacked securely in place and ensure proper air flow.



CODE	SIZE
Versa Trays – High Profile Shape	
VTE1418	35,5 x 45,7 cm
VTE3343	33 x 43
Versa Trays – Low Profile Shape	
VTE3253	32,5 x 53
VTE3753	37 x 53
Versa Century™ – Low Profile Design Shape	
VTE3646C	35,5 x 45,7
Versa Trays – Flat Edge Shape	
GPE0540	34,4 x 46
GPE3980	37 x 53
GPE4002*	32,5 x 53
GPE4004**	32,5 x 53

Case Pack: 12

*Designed with reinforced corners for automatic off-stacking onto conveyor belt dishwashers.

**Textured top surface to reduce sliding of dishes. Not available in (A72).

***Charcoal color A72 will show scratches if not handled properly.



Personalization: Contact your Cambro representative for pricing.

Tray Colors:

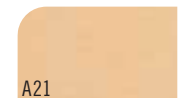

A21

Speckled Mocha

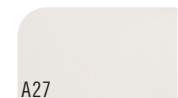

A27

Light Grey



A72

Charcoal***



A86

Terrazzo

POLYESTER VERSA TRAYS PLUS

SPECIFICATIONS

Material	SMC – high performance fiberglass reinforced polyester
Surface Characteristic	Smooth
Performance	Excellent
Stacking Lugs	Yes
Dishwasher Safe	Yes – Extensive
Chemical Resistance	Excellent
Drying Test	Excellent
Shock Resistance	Excellent
Break Resistance	Excellent
Scratch Resistance	Excellent
Stain Resistance	Excellent
Heat Resistance	-40° to +140°C‡



‡Not for use in heated carts.

Only available from Cambro European Logistics (CEL), Germany and Cambro Özay Turkey.

RECOMMENDED USE

High Traffic / Frequent Use

- Hospitals
- Schools
- Universities
- Canteens / Cafeterias / Self-Serve
- Military

STOCK PRODUCTS & COLORS AVAILABLE IN OUR EUROPEAN WAREHOUSE

VT3646C, GP1070, GP4002, GP4004, VT1418: (S60)

Minimum quantity order from CEL: Stock item one case, Non-stock item 240 pieces. No broken carton.



High Profile Shape

Low Profile Shape



Low Profile Design Shape

Flat Edge Shape



GP4002

Easy Care

Dishwasher safe - wash as often and as frequently as needed.

Stacking lugs keep trays stacked securely in place and ensure proper air flow.

Long Lasting

Increased scratch resistance.

Proprietary material blend reduces scratch visibility.

Reinforced corners and edges protect and strengthen the tray.



CODE

SIZE

Versa Trays – High Profile Shape

VT1418	35,5 x 45,7 cm
VT3343	33 x 43

Versa Trays – Low Profile Shape

VT2632	32,5 x 26,5
VT3253	32,5 x 53
VT3753	37 x 53

Versa Century™ – Low Profile Design Shape

VT3646C	35,5 x 45,7
---------	-------------

Versa Trays – Flat Edge Shape

GP1070	32,5 x 26,5
GP3980	37 x 53
GP4002	32,5 x 53
GP4004	32,5 x 53

Case Pack: 12

ANTIMICROBIAL CAMGUARD® VERSA TRAYS

SPECIFICATIONS

Material	SMC – high performance fiberglass reinforced polyester
Surface Characteristic	Smooth
Performance	Excellent
Stacking Lugs	Yes
Dishwasher Safe	Yes – Extensive
Chemical Resistance	Excellent
Drying Test	Excellent
Shock Resistance	Excellent
Break Resistance	Excellent
Scratch Resistance	Excellent
Stain Resistance	Excellent
Heat Resistance	-40° to +140°C‡



‡Not for use in heated carts.

RECOMMENDED USE

High Traffic / Frequent Use

- Hospitals
- Schools
- Universities
- Canteens / Cafeterias / Self-Serve
- Military

Only available from Cambro European Logistics (CEL), Germany and Cambro Özyay Turkey.

Minimum quantity order from CEL:

Non-stock item 240 pieces.
No broken carton.

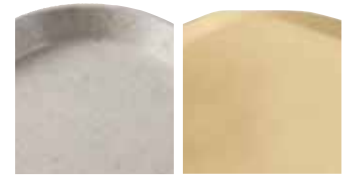

High Profile Shape

Low Profile Design Shape



Flat Edge Shape



CODE	SIZE
Versa Trays – High Profile Shape	
VT1418AB	35,5 x 45,7 cm
VT3343AB	33 x 43
Versa Century™ Trays – Low Profile Design Shape	
VT3646CAB	35,5 x 45,7
VT3343CAB	32,9 x 43
Versa Trays – Flat Edge Shape	
GP1070AB*	32,5 x 26,5
GP1080AB*	37 x 26,5
GP3980AB*	53 x 37
GP4002AB*	53 x 32,5

Case Pack: 12

*Designed with reinforced corners for automatic off-stacking onto conveyor belt dishwashers.

Trays have built-in antimicrobial properties to protect against mildew growth and bacterial odors. This protection will not wash or wear off.

Unprotected Surface versus Camguard Protected Surface 24 Hour Test

Unprotected

Protected with Camguard



Innovative low profile and low corner design increases space utilization of tray surface and customer comfort while eating.



Reinforced polyester corners provide superior corner and edge protection against impact.



Stacking lugs keep trays stacked securely in place and ensure proper air flow.

Tray Color:



A83

Granite

POLYESTER DECORATED VERSA TRAYS WITH SMOOTH OR NON-SLIP SURFACE

SPECIFICATIONS

Material	SMC – high performance fiberglass reinforced polyester + melamine surface	SMC – high performance fiberglass reinforced polyester + Non-Slip surface
Surface Characteristic	Smooth	Non-Slip
Performance	Excellent	Excellent
Stacking Lugs	Yes	Yes
Dishwasher Safe	Yes – Extensive	Yes – Extensive
Chemical Resistance	Excellent*	Good
Drying Test	Excellent	Excellent
Shock Resistance	Excellent	Excellent
Break Resistance	Excellent	Excellent
Scratch Resistance	Excellent	Good
Stain Resistance	Excellent	Good
Heat Resistance	-40° to +90°C‡	-40° to +80°C‡



‡Not for use in heated carts.

*If you are using Thermo-Chemical Disinfection Equipment, please contact us. We will assist you finding the right tray for your application.



Flat Edge Shape



Personalization: Contact your Cambro representative for pricing.

RECOMMENDED USE

High Traffic / Frequent Use

- Hospitals
- Schools
- Universities
- Canteens / Cafeterias / Self-Serve
- Military

Only available from Cambro European Logistics (CEL), Germany and Cambro Özyay Turkey.

STOCK PRODUCTS & COLORS AVAILABLE IN OUR EUROPEAN WAREHOUSE

GP4002, GP4002NS: (B93)

Minimum quantity order from CEL: Stock item one case, Non-stock item 120 pieces. No broken carton.

CODE	SIZE	CASE PACK
Smooth surface – Flat Edge Shape		
GP0540†	46 x 34,4 cm	12
GP3980†	53 x 37	12
GP4002†	53 x 32,5	12
GP4004	53 x 32,5	12
Non-slip surface** – Flat Edge Shape		
GP3980NS†	53 x 37	12
GP4002NS†	53 x 32,5	12
GP0540NS†	46 x 34,4	12
GP1080NS†	37 x 26,5	12

**Only available in colors: B22, B93, B99, B100.

†Designed with reinforced corners for automatic off-stacking onto conveyor belt dishwashers.

Patterns and Tray Base Colors:



B101
Brushed Steel on
Light Grey Tray



B27
Light Grey on
Light Grey Tray



B95
Pebbled White on
Light Grey Tray

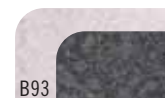

B93
Titan on
Granite Tray



B100
Pebbled Black on
Terrazzo Tray



B22
Sahara on
Sahara Tray



B99
Pebbled Black on
Light Grey Tray

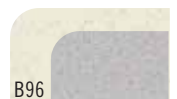

B96
Pebbled White on
Terrazzo Tray



POLYESTER VERSA TRAYS WITH SMOOTH SURFACE

SPECIFICATIONS

Material	SMC – High Performance Fiberglass Reinforced Polyester
Surface Characteristic	Smooth
Performance	Excellent
Stacking Lugs	Yes
Dishwasher Safe	Yes – Extensive
Chemical Resistance	Excellent
Drying Test	Excellent
Shock Resistance	Excellent
Break Resistance	Excellent
Scratch Resistance	Excellent
Stain Resistance	Excellent
Heat Resistance*	-40° to +140°C ‡



PRORATED

‡Not for use in heated carts.
Personalization, see page 204.
*Personalization Heat Resistance: 90°C.

RECOMMENDED USE

- High Traffic / Frequent Use
- Hospitals
 - Schools
 - Universities
 - Canteens / Cafeterias / Self-Serve
 - Military

STOCK PRODUCTS & COLORS AVAILABLE IN OUR EUROPEAN WAREHOUSE

VT1418 VT2632: (A72), (A83)
VT3253: (A72), (A83), (A86) VT3343: (A72)
VT3753: (A83) VT3646C: (A72)

Minimum quantity order from CEL:
Stock item one case, Non-stock item
120 pieces. No broken carton.



High Profile Shape Low Profile Shape



Low Profile Design Shape Flat Edge Shape

Only available from Cambro European Logistics (CEL), Germany and Cambro Özy Turkey.

CODE	SIZE	CASE PACK
Versa Trays – High Profile Shape		
VT1216	30,5 x 41,5 cm	12
VT1418	35,5 x 45,7	12
VT1418TR – Trapezoid	35,5 x 45,7	12
VT1520	38 x 51,5	12
VT3343	33 x 43	12

Versa Trays – High Profile Shape



CODE	SIZE	CASE PACK
Versa Trays – Low Profile Shape		
VT2632	32,5 x 26,5 cm	12
VT3253	32,5 x 53	12
VT3753	37 x 53	12
VT3853	37,5 x 53	12

Versa Trays – Low Profile Shape

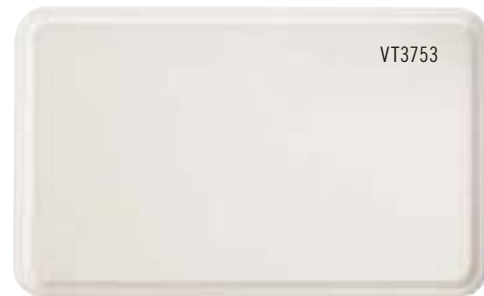

CODE	SIZE	CASE PACK
Versa Century™ Trays – Low Profile Design Shape		
VT3646C	35,5 x 45,7 cm	12
VT3343C	33 x 43	12

Versa Century Trays – Low Profile Design Shape



VT3646C

Innovative low profile and low corner design increases space utilization of tray surface and customer comfort while eating.

POLYESTER VERSA TRAYS WITH SMOOTH SURFACE

CODE	SIZE	CASE PACK
Versa Trays – Flat Edge Shape		
GP0540*	46 x 34,4 cm	12
GP1070*	32,5 x 26,5	12
GP1080*	37 x 26,5	12
GP3074	45 x 32	12
GP3788	39 x 51	12
GP3980*	53 x 37	12
GP4002*	53 x 32,5	12
GP4004**	53 x 32,5	12
GP4701	42,5 x 32,5	12
GP4709	46 x 32,5	12
GP4856*	34,5 x 23	12

*Designed with reinforced corners for automatic off-stacking onto conveyor belt dishwashers.

**Textured top surface to reduce sliding of dishes. Not available in (A72).

STOCK PRODUCTS & COLORS AVAILABLE IN OUR EUROPEAN WAREHOUSE

GP0540: (A22), (A27), (A72), (A83) GP1070: (A27), (A33) GP3980: (A27), (A36), (A83), (A86)
 GP4002: (A21), (A22), (A27), (A33), (A36), (A72), (A83), (A86) GP4210: (A27), (A83), (A86)
 GP4701: (A27), (A33), (A72), (A83), (A86) GP4709: (A27) GP55653: (A72)

Minimum quantity order from CEL:

Stock item one case, Non-stock item 120 pieces. No broken carton.

CODE	SIZE	CASE PACK
Versa Trays – Café Trays		
GP55653	40 x 27 cm	12
GP55702	26 x 20	12
GP55703	29 x 21	12

Only available from Cambro European Logistics (CEL), Germany and Cambro Özay Turkey.

CODE	SIZE	CASE PACK
Versa Trays – Space Saver Trays		
GP4210 – Trapezoid	48 x 34 cm	12
GP4410 – Trapezoid	32,5 x 42,5	12
GP4853	42,4 x 32,5	12



Hexagonal table
Lateral side:
70 cm GP4210



Square table
80 x 80 cm
GP4210



Round table
Diam. 135 cm
GP4853



Square Table
95 x 95 cm
GP4853

Versa Trays – Flat Edge Shape



Tray Colors:

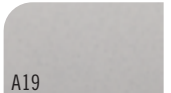

A19
Pebbled Grey*



A21
Speckled Mocha



A22
Sahara



A25
Magic Yellow



A26
Magic Mint

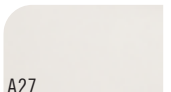

A27
Light Grey

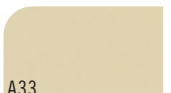

A33
Pearl White



A36
Speckled Blue



A72
Charcoal*



A83
Granite



A86
Terrazzo

Versa Trays – Café Trays



Versa Trays – Space Saver Trays



Polyester Versa Trays VT/GP are not recommended for use in heated meal delivery carts. Please contact Cambro Customer Service or Presswerk Köngen GmbH, with any questions related to proper usage or any special application. Cambro will provide you with clear instructions on correct usage of our trays to ensure you get the maximum life out of our products.

*Colors Pebbled Grey A19 and Charcoal A72 will show scratches if not handled properly.

POLYESTER VERSA LITE TRAYS WITH SMOOTH SURFACE

SPECIFICATIONS

Material	SMC – standard performance fiberglass reinforced polyester
Surface Characteristic	Smooth
Performance	Excellent
Stacking Lugs	Yes
Dishwasher Safe	Yes – Normal
Chemical Resistance	Good
Drying Test	Excellent
Shock Resistance	Good
Break Resistance	Good
Scratch Resistance	Good
Stain Resistance	Good
Heat Resistance*	-40° to +130°C‡



‡Not for use in heated carts.
Personalization, see page 204.
*Personalization Heat Resistance: 90°C.

RECOMMENDED USE

Moderate Traffic / Economic Priority

- Schools
- Universities
- Canteens / Cafeterias / Self-Serve
- Military
- Hotel Room Service

Only available from Cambro European Logistics (CEL), Germany and Cambro Özy Turkey.

Minimum quantity order from CEL:
Stock item one case, Non-stock item 120 pieces. No broken carton.

STOCK PRODUCTS & COLORS AVAILABLE IN OUR EUROPEAN WAREHOUSE

GL0540: (A22), (A27) GL1070: (A27)
GL3980: (A20)
GL4002: (A20), (A21), (A22), (A27), (A83), (A86)
GL4701: (A27)



High Profile Shape Low Profile Shape

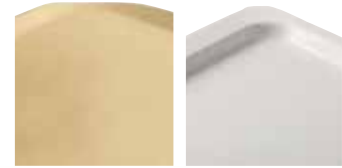

Low Profile Design Shape Flat Edge Shape



Low Profile Flat Edge Shape

CODE	SIZE
Versa Lite Trays – Flat Edge Shape	
GL0540†	46 x 34,4 cm
GL1070†	32,5 x 26,5
GL1080†	37 x 26,5
GL3074	45 x 32
GL3980†	53 x 37
GL4002†	53 x 32,5
GL4060	40 x 60
GL4701	42,5 x 32,5
GL4709	46 x 32,5

Case Pack: 12

†Designed with reinforced corners for automatic off-stacking onto conveyor belt dishwashers.

Versa Lite Trays – Flat Edge Shape



Versa Lite Trays – Space Saver Trays

CODE	SIZE
Versa Lite Trays – Space Saver Trays	
GL4210 – Trapezoid	48 x 34 cm

Case Pack: 12

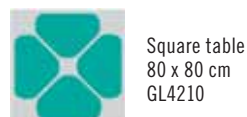

POLYESTER VERSA LITE TRAYS WITH SMOOTH SURFACE

CODE	SIZE
Versa Lite Trays – High Profile Shape	
VL1014	27 x 35 cm
VL1216	30,5 x 41,5
VL3343	33 x 43
VL1418	35,5 x 45,7
Case Pack: 12	

Versa Lite Trays – High Profile Shape



VL1418

Only available from Cambro European Logistics (CEL), Germany and Cambro Üzay Turkey.

Minimum quantity order from CEL: Stock item one case, Non-stock item 120 pieces. No broken carton.

STOCK PRODUCTS & COLORS AVAILABLE IN OUR EUROPEAN WAREHOUSE

VL1418: (A20), (A21), (A22), (A27)
 VL3253: (A20), (A21), (A33), (A86)
 VL3343: (A20), (A21)
 VL3343C: (A20)
 VL3753, VL3646C: (A27)

CODE	SIZE
Versa Lite Trays – Low Profile Flat Edge Shape	
GL220P	32,5 x 53 cm
GL210P	37 x 53
Case Pack: 12	

Versa Lite Trays – Low Profile Flat Edge Shape



GL210P

GL220P

Tray Colors:

A08
Speckled Sand

A20
Speckled Smoke

A21
Speckled Mocha

A22
Sahara

A27
Light Grey

A33
Pearl White

A83
Granite

A86
Terrazzo

CODE	SIZE
Versa Lite Trays – Low Profile Shape	
VL2632	32,5 x 26,5 cm
VL3253	32,5 x 53
VL3753	37 x 53
Case Pack: 12	

Versa Lite Trays – Low Profile Shape

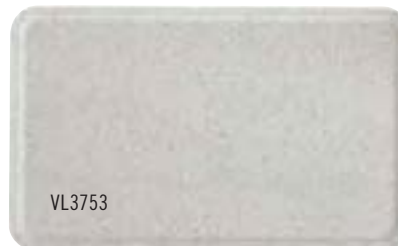

VL3753

CODE	SIZE
Versa Lite Century™ Trays – Low Profile Design Shape	
VL3646C	35,5 x 45,7 cm
VL3343C	33 x 43
Case Pack: 12	

Versa Lite Century Trays – Low Profile Design Shape



VL3646C



Innovative low profile and low corner design increases space utilization of tray surface and customer comfort while eating.

CENTURY™ FUN TRAYS — CREATE A VIBRANT TABLE TOP WITH COLOURFUL TRAYS

SPECIFICATIONS

Versa Tray

Versa Lite Tray

Material	SMC – high performance fiberglass	SMC – standard performance reinforced polyester fiberglass reinforced polyester
Surface Characteristic	Smooth	Smooth
Performance	Excellent	Excellent
Stacking Lugs	Yes	Yes
Dishwasher Safe	Yes – Extensive	Yes – Normal
Chemical Resistance	Excellent	Good
Drying Test	Excellent	Excellent
Shock Resistance	Excellent	Good
Break Resistance	Excellent	Good
Scratch Resistance	Excellent	Good
Stain Resistance	Excellent	Good
Heat Resistance*	-40° to +90°C‡	-40° to +90°C‡

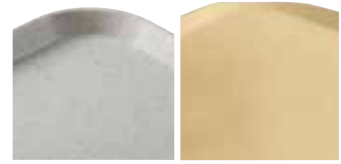

High Profile Shape Low Profile Design Shape

RECOMMENDED USE

High Traffic / Frequent Use

- Hospitals
- Schools
- Universities
- Canteens / Cafeterias / Self-Serve
- Military

‡Not for use in heated carts.
Personalization, see page 204.

*Personalization Heat Resistance: 90°C.



Century Fun Trays are made for intensive use. Scratch, stain, chemical and break-resistant, Century Fun trays are available on a pure white tray. Match the tray colour to your décor (dishes, furniture, walls, etc.).



VT3646C

Reinforced polyester corners provide superior corner and edge protection against impact.

Stacking lugs keep trays stacked securely in place and ensure proper air flow.

Innovative low profile and low corner design increases space utilization of tray surface and customer comfort while eating.

CENTURY™ FUN TRAYS – CREATE A VIBRANT TABLE TOP WITH COLOURFUL TRAYS



Personalization

Possibility to personalize to any PMS colors of your choice.

Minimum quantity: 120 pieces.

Please refer to personalization procedure and color availability in the Personalization section.

For assistance please contact your Cambro representative.

Only available from Cambro European Logistics (CEL), Germany and Cambro Özyay Turkey.

Minimum quantity order from CEL: Stock item one case, Non-stock item 120 pieces. No broken carton.

STOCK PRODUCTS & COLORS AVAILABLE IN OUR EUROPEAN WAREHOUSE

VL3343C, VL3646C, VT3343C, VT3646C: (F01), (F02), (F04), (F06), (F07), (F08), (F09), (F10), (F87), (F88), (F89)

CODE	DIMENSIONS	CASE PACK
Versa Trays		
VT1418	35,5 x 45,7 cm	12
VT3343C	33 x 43	12
VT3646C	35,5 x 45,7	12
Versa Lite Trays		
VL1418	35,5 x 45,7	12
VL3343C	33 x 43	12
VL3646C	35,5 x 45,7	12



Sage on White Tray (F01)

Raspberry on White Tray (F02)

Grape on White Tray (F03)

Pearl Grey on White Tray (F04)

New!
Aqua Blue (F06)

New!
Black (F07)

New!
Emerald Green (F08)

New!
Cassis (F09)

New!
Salmon (F10)

New!
Light Oak (F86)

New!
Brown Oak (F87)

New!
Dark Oak (F88)

New!
Light Olive (F89)

New!
Brown Olive (F90)

POLYESTER NON-SLIP VERSA LITE TRAYS

SPECIFICATIONS

Material	SMC – standard performance fiberglass reinforced polyester
Surface Characteristic	Non-Slip
Performance	Excellent
Stacking Lugs	Yes
Dishwasher Safe	Yes – Normal
Chemical Resistance	Good
Drying Test	Excellent
Shock Resistance	Good
Break Resistance	Good
Scratch Resistance	Good
Stain Resistance	Good
Heat Resistance*	-40° to +80°C‡



‡Not for use in heated carts.

Personalization: Contact your Cambro representative for pricing.

*Personalization Heat Resistance: 90°C.

RECOMMENDED USE

Intensive Use / Economic Priority

- Hospitals
- Schools
- Universities
- Canteens / Cafeterias / Self-Serve
- Military
- Catering / Cruise Ships
- Hotels / Room Service

Only available from Cambro European Logistics (CEL), Germany and Cambro Özay Turkey.

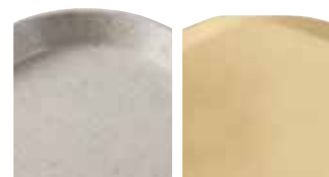

High Profile Shape

Low Profile Design Shape



Flat Edge Shape



Reinforced polyester corners provide superior corner and edge protection against impact.

Minimum quantity order from CEL: Stock item one case, Non-stock item 120 pieces. No broken carton.

STOCK PRODUCTS & COLORS AVAILABLE IN OUR EUROPEAN WAREHOUSE

6L4002NS: (B22)



Stacking lugs keep trays stacked securely in place and ensure proper air flow.



Versa Lite Century Trays have low edges and ergonomic corners that enhance comfort.

Tray Colors:



B22 Sahara on Sahara Tray



B14 Titan on Speckled Smoke Tray

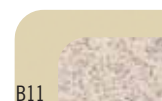

B11 Sahara on Pearl White Tray



B99 Pebbled Black on Light Grey Tray



Non-Slip Trays grip firmly providing safer meal delivery service.

CODE	SIZE
Versa Lite Trays – High Profile Shape	
VL1418NS	35,5 x 45,7 cm
VL3343NS	33 x 43
Versa Lite Century™ Trays – Low Profile Design Shape	
VL3646CNS	35,5 x 45,7
VL3343CNS	33 x 43
Versa Lite Trays – Flat Edge Shape	
GL3980NS*	53 x 37
GL4002NS*	53 x 32,5

Case Pack: 12.

*Designed with reinforced corners for automatic off-stacking onto conveyor belt dishwashers.

POLYESTER VERSA LITE TRAYS WITH NON-SLIP RUBBER SURFACE

SPECIFICATIONS

Material	SMC – standard performance fiberglass reinforced polyester + non-slip rubber
Surface Characteristic	Non-Slip Rubber
Performance	Excellent
Stacking Lugs	Yes
Dishwasher Safe	Yes – Normal
Chemical Resistance	Good
Drying Test	Excellent
Shock Resistance	Good
Break Resistance	Good
Scratch Resistance	Good
Stain Resistance	Good
Heat Resistance	-40° to +100°C‡



‡Not for use in heated carts.

RECOMMENDED USE

Moderate Traffic / Economic Priority

- Banquet Service
- Restaurant / Cafes
- Bars / Clubs / Pubs
- Catering
- Brasseries

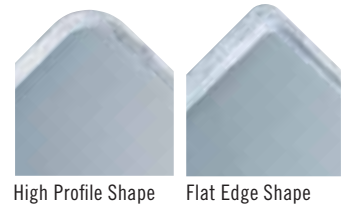

High Profile Shape Flat Edge Shape

Only available from Cambro European Logistics (CEL), Germany and Cambro Özay Turkey.

Minimum quantity order from CEL: Stock item one case, Non-stock item 120 pieces. No broken carton.

STOCK PRODUCTS & COLORS AVAILABLE IN OUR EUROPEAN WAREHOUSE

GL1070RNS: (A83)
GL4002RNS: (A83), (A87)



CODE	DIA / SIZE	CASE PACK
Versa Lite Trays – High Profile Shape		
VL1418RNS	35,5 x 45,7 cm	12
Versa Lite Trays – Flat Edge Shape		
GL1070RNS*	32,5 x 26,5	12
GL4002RNS*	53 x 32,5	12
GL3980RNS*	53 x 37	12
Versa Lite Tray – Cafe Trays		
VL2129RNS	21 x 29	12
VL3200RNS	∅ 32	12
VL3600RNS	∅ 36	12

*Designed with reinforced corners for automatic off-stacking onto conveyor belt dishwashers.

Patterns and Tray Base Colors:



CAMTRAYS® FIBERGLASS TRAYS WITH SMOOTH SURFACE

SPECIFICATIONS

Material	Fiberglass layers + polyester resin
Surface Characteristic	Smooth
Performance	Excellent
Stacking Lugs	Yes
Dishwasher Safe	Yes – Extensive
Chemical Resistance	Good
Drying Test	Excellent
Shock Resistance	Excellent
Break Resistance	Excellent
Scratch Resistance	Excellent
Stain Resistance	Excellent
Heat Resistance	-10° to +100°C‡

†Available in Group I colors and patterns and Group III patterns.

‡Not for use in heated carts. Personalization, see page 204.

ΔAvailable in Group I colors and patterns except Dolly.

*Special order item not carried in stock – non-returnable.

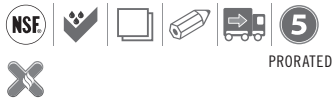

RECOMMENDED USE

High Traffic / Frequent Use

- Hospitals
- Schools
- Universities
- Canteens / Cafeterias / Self-Serve
- Military
- Hotel Room Service

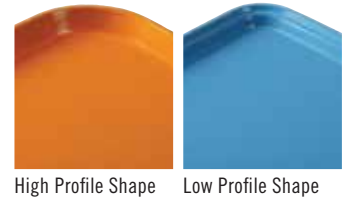

High Profile Shape

Low Profile Shape

STOCK PRODUCTS & COLORS AVAILABLE IN OUR EUROPEAN WAREHOUSE

1216: (204)



CODE	SIZE	CASE PACK
Rectangular – High Profile Shape		
810†	20,5 x 25 cm	12
915†	22 x 38	12
926*†	22,5 x 65 x 2,5	12
1014†	27 x 35	12
1015*Δ	26 x 38	24
1116*	27,5 x 40,5	24
1216†	30,5 x 41,5	12
1313†	33 x 33	12
1318*†	32 x 45 x 3	12
1418†	35,5 x 45,7	12
1520†	38 x 51,5	12
1622†	40,5 x 56	12
16225*†	42 x 57	12
1826†	45,5 x 65,5	6
Rectangular – Low Profile Shape		
46†	11 x 15	12
57*†	12,5 x 18	12
2025*†	53 x 65	6



CAMTRAYS® FIBERGLASS TRAYS WITH SMOOTH SURFACE

SPECIFICATIONS

Material	Fiberglass Layers + Polyester Resin
Surface Characteristic	Smooth
Performance	Excellent
Stacking Lugs	Yes
Dishwasher Safe	Yes – Extensive
Chemical Resistance	Good
Drying Test	Excellent
Shock Resistance	Excellent
Break Resistance	Excellent
Scratch Resistance	Excellent
Stain Resistance	Excellent
Heat Resistance	-10° to +100°C‡

†Available in Group I colors and patterns and Group III patterns.

‡Not for use in heated carts. Personalization, see page 204.

ΔAvailable in Group I colors and patterns except Doily.

*Special order item not carried in stock – non-returnable.

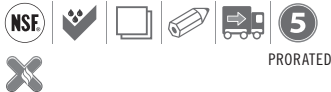

RECOMMENDED USE

High Traffic / Frequent Use

- Hospitals
- Schools
- Universities
- Canteens / Cafeterias / Self-Serve
- Military
- Hotel Room Service

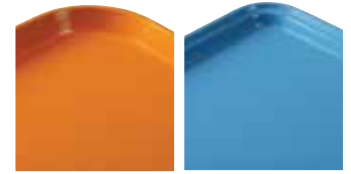

High Profile Shape

Low Profile Shape



CODE	DIA / SIZE	CASE PACK
Trapezoid – High Profile Shape		
1418TR*†	35,5 x 45,7 cm	12
1422TR*†	35,5 x 56	12
Trapezoid – Low Profile Shape		
1520TR*†	37 x 49,5	12
Oval – Low Profile Shape		
2500*Δ	49 x 61	6
2700*Δ	56 x 68,5	6
Round – High Profile Shape		
900*Δ	ø 23	12
1000*Δ	ø 25,5	12
1100Δ	ø 28	12
1200*Δ	ø 30,5	12
1300*Δ	ø 33	12
1400Δ	ø 35,5	12
1600Δ	ø 40,5	12
Round – Low Profile Shape		
1550*Δ	ø 40,5	12
1950*Δ	ø 49,5	12



CAMTRAYS® FIBERGLASS TRAYS WITH SMOOTH SURFACE

SPECIFICATIONS

Material	Fiberglass Layers + Polyester Resin
Surface Characteristic	Smooth
Performance	Excellent
Stacking Lugs	Yes
Dishwasher Safe	Yes – Extensive
Chemical Resistance	Good
Drying Test	Excellent
Shock Resistance	Excellent
Break Resistance	Excellent
Scratch Resistance	Excellent
Stain Resistance	Excellent
Heat Resistance	-10° to +100°C‡

*Special order item not carried in stock – non-returnable.

❖ Available in Group I colors only.

1418H and 1520H available in Group I colors only and covered by 2 Year prorated warranty against manufacturer's defects.

NSF listed for non-direct food contact only.



‡Not for use in heated carts.

Personalization, see page 204.

1418H and 1520H available in four color printing process only. Please refer to Fiberglass Tray Personalization section for details.

RECOMMENDED USE

High Traffic / Frequent Use

- Hospitals
- Schools
- Universities
- Canteens / Cafeterias / Self-Serve
- Military
- Hotel Room Service

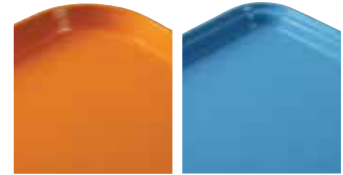

High Profile Shape Low Profile Shape

STOCK PRODUCTS & COLORS AVAILABLE IN OUR EUROPEAN WAREHOUSE

1418H: (110), (199), (538)

3242: (110)

3253: (110), (148)



1418H



CODE	SIZE	CASE PACK
Metric Rectangular – High Profile Shape		
1313	33 x 33 cm	12
3242	31,9 x 41,9	12
3853*	37,5 x 53	12
Metric Rectangular – Low Profile Shape		
2632*	26,5 x 32,5	12
3046*	30 x 46	12
3253*	32,5 x 53	12
3343	33 x 43	12
3753*	37 x 53	12
Camtray with Handles		
1418H*❖	35,5 x 45,7	12
1520H*❖	38 x 51,5	12

CAMTRAY® GROUP I COLORS

Colors listed alphabetically. See numerical reference on following page.



123
Amazon Blue



101
Antique Parchment



513
Bay Leaf Brown



110
Black



409
Blush



116
Brazil Brown



522
Burgundy Wine



521
Cambro Red



537
Cameo Yellow



505
Cherry Red



220
Citrus Orange



538
Cottage White



117
Dark Peach



104
Desert Tan



514
Earthen Gold



221
Ever Red



551
Grape



105
Horizon Blue



429
Key Lime



536
Lemon Chiffon



106
Light Peach



113
Lime-ade



504
Mustard



428
Olive Green



222
Orange Pizazz



107
Pearl Grey



410
Raspberry Cream



501
Real Rust



518
Robin Egg Blue



119
Sherwood Green



510
Signal Red



177
Sky Blue



401
Slate Blue



508
Suede Brown



199
Taupe



414
Teal



171
Tuscan Gold



148
White

Due to the catalog printing process, the colors & patterns shown may not be exact.
Contact Cambro or a Cambro representative for a color chip.

CAMTRAY® GROUP I PATTERNS

Galaxy

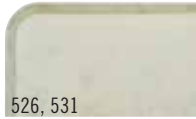

526, 531
Antique Parchment
(526 Gold), (531 Silver)

Swirl



270
Black & Gold



277
Grey

Doily



241
Antique Parchment

Abstract



214
Tan



215
Grey

Trays are non-returnable.



CAMTRAY GROUP III – WOOD

Wood



308
Burma Teak



304
Country Oak



301
Dark Basketweave



309
Java Teak

Linen

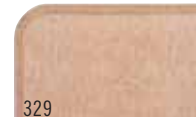

329
Toffee



302
Light Basketweave



303
Light Butcher Block



307
Light Elm



204
Rattan

Trays are non-returnable.

CAMTRAY GROUP I COLORS – NUMERICAL REFERENCE BY COLOR CODE

Antique Parchment (101),
Desert Tan (104), Horizon Blue (105),
Light Peach (106), Pearl Gray (107),
Black (110), Lime-ade (113),
Brazil Brown (116), Dark Peach (117),
Sherwood Green (119),
Amazon Blue (123), White (148),

Tuscan Gold (171), Sky Blue (177),
Taupe (199), Citrus Orange (220),
Ever Red (221) Orange Pizazz (222),
Slate Blue (401), Blush (409),
Raspberry Cream (410),
Teal (414), Olive Green (428),
Key Lime (429), Real Rust (501),

Mustard (504), Cherry Red (505),
Suede Brown (508), Signal Red (510),
Bayleaf Brown (513),
Earthen Gold (514),
Robin Egg Blue (518),
Cambro Red (521),
Burgundy Wine (522),

Lemon Chiffon (536),
Cameo Yellow (537),
Cottage White (538), Grape (551).

Due to the catalog printing process, the colors & patterns shown may not be exact.
Contact Cambro or a Cambro representative for a color chip.

NON-SLIP VERSA CAMTRAYS®

- Non-Slip Camtrays provide a better grip for safer meal delivery.
- Stacking lugs keep trays stacked securely in place and ensure proper air flow.
- Temperature range resistance from -40° to 80°C.‡
- Contoured handles allow for safe and elegant meal delivery.

Colors: Black with Pebbled Black (382), Pearl Gray with Titan (381), Ivory with Sahara (380).

Non-Slip Versa Camtrays with Handles are covered by U.S. Patent D 683,191 S.



Personalization: Contact your Cambro representative for pricing.

‡Not recommended for heated carts.



High Profile Shape Flat Edge Shape

1418VCH



1418VC

Black with Pebbled Black (382)

Pearl Gray with Titan (381)

Ivory with Sahara (380)

CODE	SIZE	CASE PACK
Non-Slip Versa Camtrays		
1418VC	35,5 x 45,7 cm	12
1520VC	38 x 51	12
Non-Slip Versa Camtrays with handles		
1418VCH	35,5 x 45,7	12
1520VCRST	38 x 51	12

DIETARY TRAYS

SPECIFICATIONS

Material	Fiberglass layers + polyester resin
Surface Characteristic	Smooth
Performance	Excellent
Stacking Lugs	Yes
Dishwasher Safe	Yes – Extensive
Chemical Resistance	Good
Drying Test	Excellent
Shock Resistance	Excellent
Break Resistance	Good
Scratch Resistance	Good
Stain Resistance	Excellent
Heat Resistance	-10° to +100°C‡

‡Not for use in heated carts.

CAMLITE® TRAYS

SPECIFICATIONS

Material	Fiberglass layers + polyester resin
Surface Characteristic	Smooth
Performance	Excellent
Stacking Lugs	Yes
Dishwasher Safe	Yes – Extensive
Chemical Resistance	Good
Drying Test	Excellent
Shock Resistance	Excellent
Break Resistance	Good
Scratch Resistance	Good
Stain Resistance	Excellent
Heat Resistance	-10° to +100°C‡

‡Not for use in heated carts.

RECOMMENDED USE

High Traffic / Frequent Use
– Hospitals
– Schools
– Universities
– Canteens / Cafeterias / Self-Serve
– Military
– Hotel Room Service

Available in Group I colors and patterns and Group III Patterns.

*Special order item not carried in stock – non-returnable.



RECOMMENDED USE

High Traffic / Frequent Use
– Hospitals
– Schools
– Universities
– Canteens / Cafeterias / Self-Serve
– Military
– Hotel Room Service

Colors: Rose Red (163), Yellow (145), Green (162), Blue (142), Tan (161), Steel White (676), Steel Red (675), Steel Blue (674), Black (110).

12 dozen minimum order required for any special color orders.



CODE	SIZE	CASE PACK
Dietary Trays – Low Profile Shape		
1216D*	30,5 x 41,5 cm	12
1219D*	30,5 x 48,3	12
1220D*	30,5 x 51	12
1222D*	30,5 x 56	12
1418D*	35,5 x 45,7	12
1520D*	38 x 51,3	12



CODE	SIZE	CASE PACK
Rectangular Camlite Trays – High Profile Shape		
1014CL	27 x 35 cm	12
1216CL	30,5 x 41,5	12
1418CL	35,5 x 45,7	12
1520CL	38 x 51,5	12
1826CL	45,5 x 65,5	12
Rectangular Camlite Trays – Low Profile Shape		
3253CL	32,5 x 53	12

CAMWEAR® TRAYS

SPECIFICATIONS

Material	Camwear
Surface Characteristic	Textured
Performance	Excellent
Stacking Lugs	Yes
Dishwasher Safe	Yes – Extensive
Chemical Resistance	Good
Drying Test	Excellent
Shock Resistance	Excellent
Break Resistance	Excellent
Scratch Resistance	Very Good
Stain Resistance	Very Good
Heat Resistance	-40° to +99°C‡



‡Not for use in heated carts.

RECOMMENDED USE

Moderate Traffic / Economic Priority

- Schools
- Universities
- Canteens / Cafeterias / Self-Serve
- Military
- Quick Serve Restaurants
- Food Courts / Snack Shops

Colors: Blue (168), Beige (133), Black (110), Smoked Metal (485), Dark Cranberry (488).

NSF listed for non-direct food contact only.

CAMWEAR TRAYS WITH NON-SLIP SURFACE SPECIFICATIONS

Material	Camwear
Surface Characteristic	Non-Slip
Performance	Excellent
Stacking Lugs	Yes
Dishwasher Safe	Yes – Extensive
Chemical Resistance	Good
Drying Test	Excellent
Shock Resistance	Excellent
Break Resistance	Excellent
Scratch Resistance	Good
Stain Resistance	Good
Heat Resistance	-40° to +82°C‡



‡Not for use in heated carts.

RECOMMENDED USE

Moderate Traffic / Economic Priority

- Schools / Universities
- Canteens / Cafeterias / Self-Serve
- Military
- Quick Serve Restaurants
- Food Courts / Snack Shops
- Restaurants / Cafes
- Brasseries
- Hotels / Room Service
- Hospitals

Colors: Black (110), Smoked Metal (485), Dark Cranberry (488).

NSF listed for non-direct food contact only.



CODE	SIZE	CASE PACK
Rectangular – High Profile Shape		
1418CW	35,5 x 45,7 cm	12
1520CW	38 x 51	12
Rectangular With Handles – High Profile Shape		
1418CWH New!	35,5 x 45,7	12
1520CWH New!	38 x 51	12
Trapezoid – High Profile Shape		
1418TRCW	35,5 x 45,7	12

STOCK PRODUCTS & COLORS AVAILABLE IN OUR EUROPEAN WAREHOUSE

1418CWNS: (488)

Black (110)

Dark Cranberry (488)

Smoked Metal (485)



CODE	SIZE	CASE PACK
Rectangular – High Profile Shape		
1418CWNS	35,5 x 45,7 cm	12
1520CWNS	38 x 51	12
Rectangular With Handles – High Profile Shape		
1418CWNSH New!	35,5 x 45,7	12
1520CWNSH New!	38 x 51	12

CAMTREAD® FIBERGLASS TRAYS WITH NON-SLIP RUBBER SURFACE

SPECIFICATIONS

Material	Fiberglass layers + polyester resin + non-slip rubber surface molded from edge-to-edge
Surface Characteristic	Non-Slip Rubber
Performance	Excellent
Stacking Lugs	Yes
Dishwasher Safe	Yes – Extensive
Chemical Resistance	Good
Drying Test	Excellent
Shock Resistance	Excellent
Break Resistance	Good
Scratch Resistance	Excellent
Stain Resistance	Good
Heat Resistance	-10° to +100°C‡

Orders for non-standard Camtread Tray colors will be handled by special quotation only.

*Special order item not carried in stock – non-returnable.

Not for use in heated carts.

Personalization see page 205 for size and detail.



RECOMMENDED USE

High Traffic / Frequent Use

- Banquet Service
- Restaurants / Cafes
- Bars / Clubs / Pubs
- Catering
- Brasseries

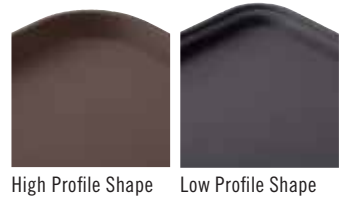

High Profile Shape

Low Profile Shape

STOCK PRODUCTS & COLORS AVAILABLE IN OUR EUROPEAN WAREHOUSE

1014CT, 1100CT, 1216CT, 1826CT, 2500CT, 2900CT, 3253CT: (110)
1400CT, 1418CT, 1600CT, 1800CT, 2700CT: (110), (138)

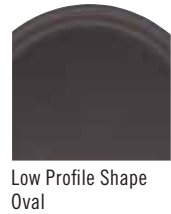

Low Profile Shape Oval



Tray Colors:

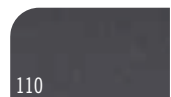

110

Black Satin

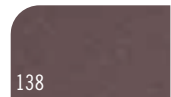

138

Tavern Tan

CODE	DIA / SIZE	CASE PACK
Round – High Profile Shape		
900CT*	∅ 23 cm	12
1100CT	∅ 28	12
1400CT	∅ 35,5	12
1600CT	∅ 40,5	12
1800CT	∅ 45	6
Round – Low Profile Shape		
1550CT*	∅ 40,5	12
1950CT*	∅ 49,5	12
Oval – Low Profile Shape		
2500CT	49 x 59	6
2700CT	56 x 68,5	6
2900CT	73,5 x 60	6
Rectangular – High Profile Shape		
1014CT*	27 x 35	12
1216CT	30,5 x 41,5	12
1418CT	35,5 x 45,7	12
1520CT*	38 x 51,5	12
1622CT*	40,5 x 56	12
1826CT	45 x 65	6
Rectangular – Low Profile Shape		
3253CT	32,5 x 53	12



TREADLITE™ TRAYS

SPECIFICATIONS

Material	Fiberglass layers + polyester resin + Non-slip rubber surface
Surface Characteristic	Non-Slip rubber surface
Performance	Good
Stacking Lugs	Yes
Dishwasher Safe	Yes – Extensive
Chemical Resistance	Good
Drying Test	Good
Shock Resistance	Good
Break Resistance	Good
Scratch Resistance	Good
Stain Resistance	Good
Heat Resistance	-10° to +80°C‡



‡Not for use in heated carts.

RECOMMENDED USE

Moderate Traffic / Economic Priority

- Brasseries
- Restaurants / Cafes
- Bars / Clubs / Pubs

STOCK PRODUCTS & COLORS AVAILABLE IN OUR EUROPEAN WAREHOUSE

1400TL, 1600TL: (110)



CODE	DIA	CASE PACK
Round – High Profile Shape		
1400TL	ø 35,5 cm	12
1600TL	ø 40,5	12

Tray Colors:

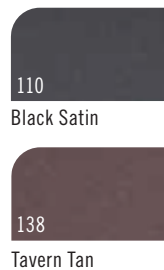

POLYTREAD® TRAYS

SPECIFICATIONS

Material	Polypropylene + Non-Slip rubber surface
Surface Characteristic	Non-Slip rubber surface
Performance	Good
Stacking Lugs	Yes
Dishwasher Safe	Yes – Minimal
Chemical Resistance	Good
Drying Test	Good
Shock Resistance	Good
Break Resistance	Good
Scratch Resistance	Good
Stain Resistance	Good
Heat Resistance	-10° to +80°C‡



‡Not for use in heated carts.

RECOMMENDED USE

Moderate Traffic / Economic Priority

- Brasseries
- Restaurants / Cafes
- Bars / Clubs / Pubs



Tray Colors:

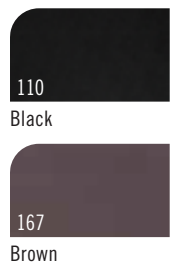

CODE	DIA / SIZE	CASE PACK
Round – High Profile Shape		
PT1100	ø 28 cm	12
PT1400	ø 35,5	12
PT1600	ø 40,5	12
Rectangular – High Profile Shape		
PT1014	27 x 34,5	24
PT1216	30 x 41,5	24
PT1418	36 x 46	12

EPICTREAD™ TRAYS

SPECIFICATIONS

Material	Fiberglass Layers + Non-Slip, Water Repellent Surface
Surface Characteristic	Non-Slip Surface
Performance	Good
Stacking Lugs	Yes
Dishwasher Safe	Yes – Minimal
Chemical Resistance	Good
Drying Test	Good
Shock Resistance	Good
Break Resistance	Good
Scratch Resistance	Good
Stain Resistance	Good
Heat Resistance	-10° to +90°C‡

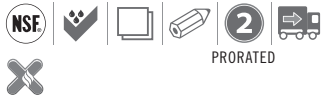

‡Not for use in heated carts.

RECOMMENDED USE

Mild Use / Emphasis on style with limited washing

- Banquet Service
- Restaurants / Cafes
- Bars / Clubs / Pubs
- Catering
- Brasseries

- Black (110)
- White (148)
- Spanish Blue (503)
- Dark Burgundy Wine (207)
- Dark Green (206)
- Cambro Red (521)



CODE	DIAMETER	CASE PACK
1400ET	ø 39 cm	12
1600ET	ø 43,7	12

MAHOGANY WOOD TRAYS WITH NON-SLIP SURFACE SPECIFICATIONS

Material	Mahogany Veneer
Surface Characteristic	Non-Slip Surface
Performance	Good
Stacking Lugs	No
Dishwasher Safe	Yes – Minimal
Chemical Resistance	Good
Drying Test	Good
Shock Resistance	Good
Break Resistance	Good
Scratch Resistance	Good
Stain Resistance	Good
Heat Resistance	-10° to +100°C‡



‡Not for use in heated carts.

RECOMMENDED USE

Mild Use / Emphasis on style with limited washing

- Banquet Service
- Restaurants / Cafes
- Bars / Clubs / Pubs
- Catering
- Brasseries

Only available from Cambro European Logistics (CEL), Germany and Cambro Özyay Turkey.



CODE	DIA / SIZE	CASE PACK
Rectangular		
MW3245	32 x 45 cm	12
MW3858	37,5 x 57,5	12
MW3646	36 x 46	12
Oval		
MW2129	21 x 29	12
Round Beer Tray		
MW3200	ø 32	12
MW3600	ø 36	12
MW4200	ø 42	12

BEECHWOOD TRAYS WITH SMOOTH SURFACE SPECIFICATIONS

Material	Veneer Beechwood
Surface Characteristic	Smooth
Performance	Good
Stacking Lugs	No
Dishwasher Safe	Yes – Normal
Chemical Resistance	Good
Drying Test	Good
Shock Resistance	Good
Break Resistance	Good
Scratch Resistance	Good
Stain Resistance	Good
Heat Resistance	-10° to +100°C‡



‡Not for use in heated carts.

RECOMMENDED USE

Mild Use / Emphasis on style with limited washing

- Banquet Service
- Restaurants / Cafes
- Catering



Tray Color:



CODE	DIA / SIZE	CASE PACK
Rectangular – 60 Series		
PH556010	45 x 32 cm	12
PH556020	58 x 38	12
PH556030	63 x 40	12
PH556040	70 x 45	12
PH556050	75 x 48	12
Rectangular – 65 Series		
PH556510	27 x 20	12
PH556520	33 x 23	12
Oval		
PH557010	23 x 16	24
PH557020	26 x 20	24
PH557030	29 x 21	24
PH557040	33 x 24	24
Round Beer Tray		
PH558510	ø 32	12
PH558520	ø 36	12
PH558530	ø 42	12

BEECHWOOD TRAYS WITH NON-SLIP SURFACE SPECIFICATIONS

Material	Veneer Beechwood
Surface Characteristic	Non-Slip Surface
Performance	Good
Stacking Lugs	No
Dishwasher Safe	Yes – Minimal
Chemical Resistance	Good
Drying Test	Good
Shock Resistance	Good
Break Resistance	Good
Scratch Resistance	Good
Stain Resistance	Good
Heat Resistance	-10° to +100°C‡



‡Not for use in heated carts.

RECOMMENDED USE

Mild Use / Emphasis on style with limited washing

- Banquet Service
- Restaurants / Cafes
- Bars / Clubs / Pubs
- Catering
- Brasseries

Only available from Cambro European Logistics (CEL), Germany and Cambro Özay Turkey.

STOCK PRODUCTS & COLORS AVAILABLE IN OUR EUROPEAN WAREHOUSE

PH556056: (000)

Minimum quantity order from CEL: Stock item one case, Non-stock item 120 pieces. No broken carton.



Tray Color:



CODE	DIA / SIZE	CASE PACK
Rectangular – 60 Series		
PH556016	45 x 32 cm	12
PH556026	58 x 38	12
PH556036	63 x 40	12
PH556046	70 x 45	12
PH556056	75 x 48	12
Rectangular – 65 Series		
PH556516	27 x 20	12
PH556526	33 x 23	12
Oval		
PH557016	23 x 16	24
PH557026	26 x 20	24
PH557036	29 x 21	24
PH557046	33 x 24	24
Round Beer Tray		
PH558516	ø 32	12
PH558526	ø 36	12
PH558536	ø 42	12

CORFU – LAMINATED TRAYS WITH NON-SLIP RUBBER SURFACE

SPECIFICATIONS

Material	Laminate + non-slip rubber surface
Surface Characteristic	Non-Slip rubber surface
Performance	Excellent
Stacking Lugs	No
Dishwasher Safe	Yes – Normal
Chemical Resistance	Excellent
Drying Test	Good
Shock Resistance	Good
Break Resistance	Good
Scratch Resistance	Good
Stain Resistance	Good
Heat Resistance	-10° to +100°C‡



Personalization,
see page 205.

‡Not for use in heated carts.

Note: All laminated trays must
be dried before stacking.

RECOMMENDED USE

Normal Use / Emphasis on style
with limited washing

- Canteens / Cafeterias / Self-Serve
- Banquet Service
- Restaurants / Cafes
- Bars / Clubs / Pubs
- Catering

Only available from Cambro European Logistics (CEL), Germany and Cambro Özyay Turkey.

Minimum quantity order from CEL:
Stock item one case, Non-stock item
120 pieces. No broken carton.

STOCK PRODUCTS & COLORS AVAILABLE IN OUR EUROPEAN WAREHOUSE

C03200, C03343, C03800, C04300,
C03646: (D01)



CODE	DIA / SIZE	CASE PACK
Rectangular		
C02632	26,5 x 32,5 cm	12
C03253	32,5 x 53	12
C03343	33 x 43	12
C03646	36 x 46	12
C03753	37 x 53	12
Round		
C03200	∅ 32	12
C03800	∅ 38	12
C04300	∅ 43	12

Tray Color:

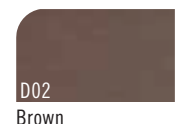

MYKONOS – LAMINATED TRAYS WITH NON-SLIP SURFACE

SPECIFICATIONS

Material	Laminate + Non-Slip Surface
Surface Characteristics	Non-Slip Surface
Performance	Good
Stacking Lugs	No
Dishwasher Safe	Yes – Minimal
Chemical Resistance	Good
Drying Test	Good
Shock Resistance	Good
Break Resistance	Good
Scratch Resistance	Good
Stain Resistance	Good*
Heat Resistance	-10° to +100°C‡



Personalization,
see page 205.

PRORATED

‡Not for use in heated carts.

Note: All laminated trays must be dried before stacking.

*Limited stain resistance for Birch (E75).

RECOMMENDED USE

Moderate Use / Emphasis on Style with Limited Washing

- Banquet Services
- Restaurants / Cafes
- Bars / Clubs / Pubs
- Catering

Only available from Cambro European Logistics (CEL), Germany and Cambro Üzay Turkey.

Minimum quantity order from CEL: Stock item one case, Non-stock item 120 pieces. No broken carton.

STOCK PRODUCTS & COLORS AVAILABLE IN OUR EUROPEAN WAREHOUSE

MY2129, MY2632, MY3253, MY3800, MY4300, MY4361: (E76)
MY2738: (E75)
MY3343: (E75), (E76)
MY3646: (E73), (E76)



Tray Colors:



E73 Mahogany



E75 *Birch



E76 Walnut



E77 Teak



E79 Black



E82 Charcoal Granite



CODE	DIA / SIZE	CASE PACK
Rectangular		
MY2632	26,5 x 32,5 cm	24
MY2738	27 x 38	24
MY3244	32 x 44	24
MY3253	32,5 x 53	24
MY3343	33 x 43	24
MY3446	34 x 46	24
MY3646	36 x 46	24
MY3753	37 x 53	24
MY3952	39 x 52	24
MY4361	43 x 61	12
Oval		
MY2026	20 x 26,5	24
MY2129	21 x 29	24
Round		
MY3200	∅ 32	24
MY3800	∅ 38	24
MY4300	∅ 43	24

CAPRI – LAMINATED TRAYS WITH SMOOTH SURFACE

SPECIFICATIONS

Material	Laminate
Surface Characteristic	Smooth
Performance	Good
Stacking Lugs	No
Dishwasher Safe	Yes – Normal
Chemical Resistance	Excellent
Drying Test	Good
Shock Resistance	Good
Break Resistance	Good
Scratch Resistance	Good
Stain Resistance	Excellent
Heat Resistance	-10° to +100°C‡

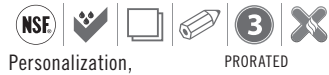

Personalization,
see page 205.

PRORATED

‡Not for use in heated carts.

Note: All laminated trays must be dried before stacking.

RECOMMENDED USE

Moderate Traffic / Economic Priority

- Canteens / Cafeterias / Self-Serve
- Hotel Room Service
- Restaurants / Cafes
- Bars / Clubs / Pubs
- Catering
- Brasseries

Only available from Cambro European Logistics (CEL), Germany and Cambro Özyay Turkey.

STOCK PRODUCTS & COLORS AVAILABLE IN OUR EUROPEAN WAREHOUSE

CA4064H: (E76), (E84)

CODE	OUTER DIMENSIONS	INNER DIMENSIONS
Rectangular with Handles		
CA4064H	40 x 64 cm	35,6 x 53,3 cm
Case Pack: 12		

Capri – Rectangular with Handles



Brushed Steel
(E85)

Venge
(E84)

Walnut
(E76)



CAPRI – LAMINATED TRAYS WITH SMOOTH SURFACE

Capri – Round



Tray Pattern:
Thank You (E01)
available in
CA1300 only.

Capri – Trapezoid and Oval



Only available from Cambro
European Logistics (CEL), Germany
and Cambro Özyay Turkey.

Minimum quantity order from CEL:
Stock item one case, Non-stock item
120 pieces. No broken carton.

STOCK PRODUCTS & COLORS AVAILABLE IN OUR EUROPEAN WAREHOUSE

CA2632: (E88), (E89)
CA2738: (E76), (E86), (E87), (E88), (E89), (E90)
CA2836, CA3753: (E76), (E88), (E89)
CA3253: (E75), (E76), (E86), (E87), (E88), (E89)
CA3343, CA3646: (E73), (E75), (E76), (E82)
CA3446: (E73), (E75), (E82)
CA3748: (E73), (E82)
CA4361: (E73), (E76)

Capri – Rectangular



CODE	DIMENSIONS	CASE PACK
Rectangular		
CA2028	20 x 28 cm	24
CA2632	26,5 x 32,5	24
CA2738	27 x 38	24
CA2836	28 x 36	24
CA3244	32 x 44	24
CA3253	32,5 x 53	24
CA3343	33 x 43	24
CA3446	34 x 46	24
CA3646	36 x 46	24
CA3748	37 x 48	24
CA3753	37 x 53	24
CA3952	39 x 52	24
CA4361	43 x 61	12
Round		
CA1300	ø 13	24
CA3200	ø 32	24
CA3800	ø 38	24
CA4300	ø 43	24
Trapezoid		
CA3247TR	32 x 47	24
Oval		
CA1623	16 x 23	24
CA2026	20 x 26,5	24
CA2129	21 x 29	24

Tray Colors:

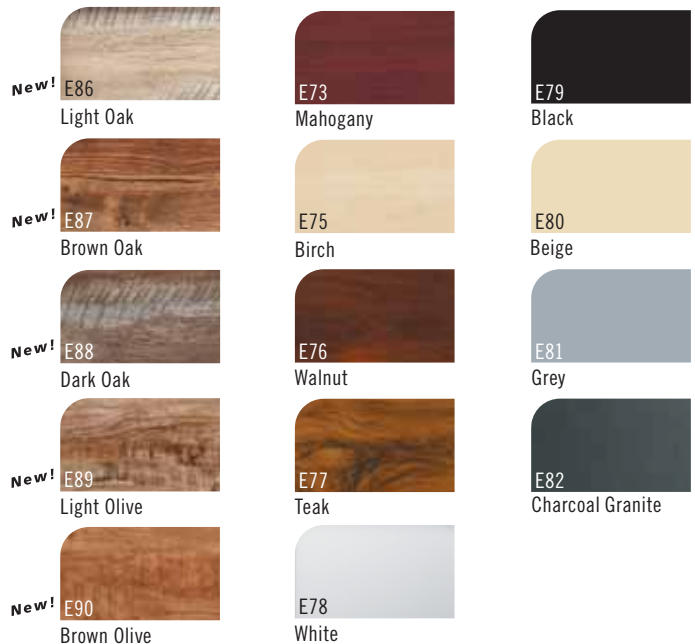

MADEIRA – LAMINATED TRAYS WITH TEXTURED WOOD SURFACE

SPECIFICATIONS

Material	Laminate
Surface Characteristics	Textured – Top and Bottom
Performance	Good
Stacking Lugs	No
Dishwasher Safe	Yes – Normal
Chemical Resistance	Excellent
Drying Test	Good
Shock Resistance	Good
Break Resistance	Good
Scratch Resistance	Good
Stain Resistance	Excellent
Heat Resistance	-10° to +100°C‡

RECOMMENDED USE

Moderate Traffic / Economic Priority

- Canteens / Cafeterias / Self-Serve
- Hotel Room Service
- Restaurants / Cafes
- Bars / Clubs / Pubs

Only available from Cambro European Logistics (CEL), Germany and Cambro Özyay Turkey.

STOCK PRODUCTS & PATTERNS AVAILABLE IN OUR EUROPEAN WAREHOUSE

MA2028, MA2435, MA3343, MA3646, MA3753: (E86), (E87), (E88), (E89), (E90)

Minimum quantity order from CEL: Stock item one case, Non-stock item 120 pieces. No broken carton.



‡Not for use in heated carts.

Note: All laminated trays must be dried before stacking.

Personalization, see page 205.



Tray Colors:

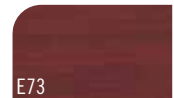

E73 Mahogany

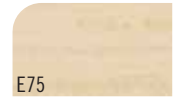

E75 Birch



E76 Walnut



E77 Teak

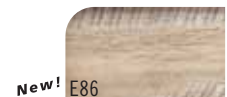

New! E86 Light Oak



New! E87 Brown Oak



New! E88 Dark Oak

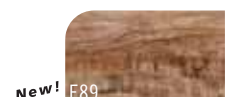

New! E89 Light Olive



New! E90 Brown Olive



CODE	DIA / SIZE	CASE PACK
Rectangular		
MA2028 New!	20 x 28 cm	24
MA2435	24 x 35	24
MA3343	33 x 43	24
MA3646	36 x 46	24
MA3753	37 x 53	24
MA4361	43 x 61	12
Rectangular with handle		
MA3142H	31 x 42	24
Trapezoid		
MA3652TR	36 x 52	24
Round		
MA3200	∅ 32	24
MA3800	∅ 38	24
MA4300	∅ 43	24

FAST FOOD TRAYS

SPECIFICATIONS

Material	Polypropylene
Surface Characteristic	Textured
Performance	Good
Stacking Lugs	Yes
Dishwasher Safe	Yes-Minimal**
Chemical Resistance	Excellent
Drying Test	Good
Shock Resistance	Good
Break Resistance	Good
Scratch Resistance	Good
Stain Resistance	Good
Heat Resistance	-10° to +80°C‡

*Available in the following colors: Black (110), Sherwood Green (119), Orange (166), Brown (167), Cranberry (416).

‡Not for use in heated carts.
 **Wash once per day for 60 seconds at a maximum temperature of 80°C.

*Personalization not available.
 Product non-returnable.



RECOMMENDED USE

Moderate Traffic / Economic Priority

- Quick Serve Restaurants
- Food Courts / Snack Shops

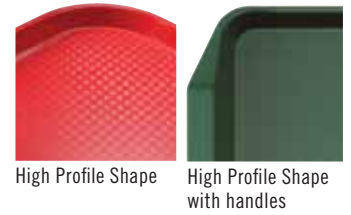

STOCK PRODUCTS & COLORS AVAILABLE IN OUR EUROPEAN WAREHOUSES

- 1014FF, 1216FF:** (110), (119), (163), (167), (168), (186)
1418FF: (107), (110), (119), (163), (167), (168), (186)
1217FFH: (110), (119), (166), (167), (416)



Available Colors:



CODE	SIZE	CASE PACK
Rectangular – High Profile Shape		
1014FF	26,5 x 34,5 cm	24
1216FF	30 x 41	24
1418FF	35,5 x 45,7	12
Rectangular – High Profile Shape with Handles		
1217FFH*	30 x 43	24



Personalization, see page 205.

COMPARTMENT TRAYS

SPECIFICATIONS

Code	10146CW	BCT1014	PS1014
Material	Camwear®	ABS	Co-Polymer
Surface Characteristic	Textured	Textured	Textured
Performance	Excellent	Excellent	Excellent
Stacking Lugs	Yes	Yes	Yes
Dishwasher Safe	Yes – Extensive	Yes – Extensive	Yes – Minimal
Chemical Resistance	Good	Excellent	Excellent
Drying Test	Excellent	Excellent	Excellent
Shock Resistance	Excellent	Good	Good
Break Resistance	Excellent	Good	Excellent
Scratch Resistance	Very Good	Very Good	Very Good
Stain Resistance	Very Good	Very Good	Very Good
Heat Resistance	-40° to +99°C‡	-10° to +82°C‡	-10° to +80°C‡

‡Not for use in heated carts.

RECOMMENDED USE

Moderate Traffic / Economic Priority

- School
- Universities
- Military

ABS and Co-Polymer trays are not NSF listed.



Camwear

NSF 3 PRORATED

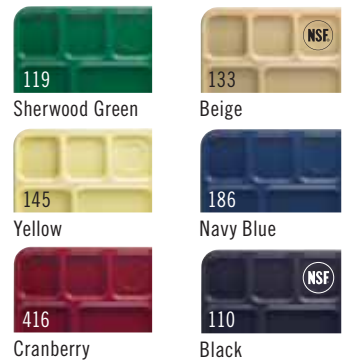

ABS

2 PRORATED



Co-Polymer

2 PRORATED



150CW, 100CW, 50CW, 45CW, 35CW, 10CW and SRB5CW reusable bowls fit in this tray and can be used to serve cereal, soup & salads.



PS1014 on OETR314 Open End Tray Rack.



BCT1014, PS1014 & 10146CW

CODE	SIZE	CASE PACK
Camwear		
10146CW	25,4 x 36,5 cm	24
ABS - BPA FREE		
BCT1014	25,4 x 36,5	24
Co-Polymer - BPA FREE		
PS1014	25,4 x 36,5	24

COMPARTMENT TRAYS

SPECIFICATIONS

Material	Camwear®	Co-Polymer
Surface Characteristic	Textured	Textured
Performance	Excellent	Excellent
Stacking Lugs	Yes	Yes
Dishwasher Safe	Yes – Extensive	Yes – Minimal
Chemical Resistance	Good	Excellent
Drying Test	Excellent	Excellent
Shock Resistance	Excellent	Good
Break Resistance	Excellent	Excellent
Scratch Resistance	Very Good	Very Good
Stain Resistance	Very Good	Very Good
Heat Resistance	-40° to +99°C‡	-10° to +80°C‡

‡Not for use in heated carts.

RECOMMENDED USE

Moderate Traffic / Economic Priority

- School
- Universities
- Military

100CW, SRB13CW and 50CW bowls fit in round compartment. 10CW and 150CW bowls fit in square compartment. See Dinnerware and Swirl Bowl sections.

ABS and Co-Polymer trays are not NSF listed.



915CP



1596CW



915CW and 1596CW inside two PR314 Camracks.

Camwear

NSF 3 PRORATED

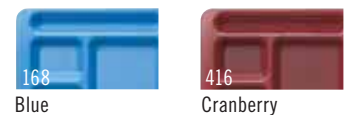

Co-Polymer

2 PRORATED

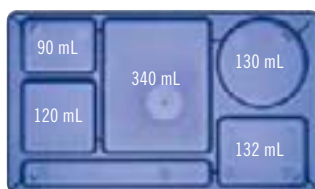

915CW & 915CP



1596CW & 1596CP

CODE	SIZE	CASE PACK
Camwear		
1596CW	22,9 x 38 cm	24
915CW	22,2 x 38	24
Co-Polymer - BPA FREE		
1596CP	22,9 x 38	24
915CP	22,2 x 38	24

MEAL DELIVERY TRAYS

- Three deep-dish food compartments for large portions.
- Snap-on cover fits securely.
- Textured surface minimizes scratching.

Camwear Colors:
Beige (133), Teal (414).
Lid Color: Clear (135).

Co-Polymer Colors:
Teal (414), Brown (167), Tan (161).
Lid Color: White (148).

Co-Polymer is not NSF Listed.

Not for use in heated carts.



Camwear®

NSF 3 PRORATED



Co-Polymer

2 PRORATED

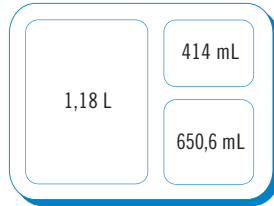

9113CW/9113CP

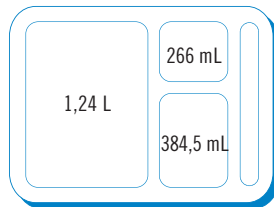

9114CW/9114CP

CODE	DESCRIPTION	DIMENSIONS W x L x D
Camwear		
9113CW	3 Compartments	22,8 x 27,9 x 6,8 cm
9114CW	4 Compartments	22,8 x 27,8 x 6,7
911CWC	Lid fits both trays	22,9 x 28 x 1,4
Co-Polymer - BPA FREE		
9113CP	3 Compartments	22,5 x 27,2 x 6,6
9114CP	4 Compartments	22,6 x 27,2 x 6,6
911CPC	Lid fits both trays	22,6 x 27,4 x 1,4

Case Pack: 24

SEPARATOR® COMPARTMENT TRAYS

- Six compartment tray designed specifically for in-cell feeding programs.
- Serve both hot and cold food from the same tray.
- Tray with cover separates each compartment to retain food temperature and reduce spills.
- Locking ridges on top of cover and bottom of tray ensure more secure stacking.

Camwear Color: Beige (133).
Lid Color: Clear (135).

Co-Polymer Colors:
Teal (414), Brown (167), Tan (161).
Lid Color: Translucent (190).

Co-Polymer is not NSF Listed.

Not recommended for heated cart.



Camwear

NSF 3 PRORATED



Co-Polymer

2 PRORATED

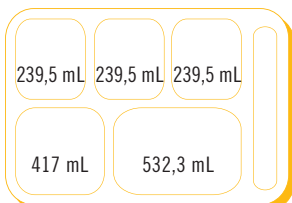

10146DCW/10146DCP

CODE	DESCRIPTION	DIMENSIONS W x L x D
Camwear		
10146DCW	6 Compartments	25,4 x 36,1 x 3,3 cm
10146DCWC	Lid fits 10146DCW	26 x 36,2 x 3,5
Co-Polymer - BPA FREE		
10146DCP	6 Compartments	25,4 x 36 x 2,9
10146DCPC	Lid fits 10146DCP	25,6 x 35,6 x 3,6

Case Pack: 24

TRAY ON TRAY MEAL DELIVERY SYSTEM

Base Tray

- Combine hot and cold food portions into a reusable, single service unit.
- Works as a tray or for in-cell feeding with the insert tray.
- Base tray has 5 compartments with 1 compartment for resting the insert tray.

Camwear Color: Beige (133).

Co-Polymer Colors: Brown (167), Tan (161).

Co-Polymer is not NSF Listed.

Not for use in heated carts.



1411CW



1411CW base tray with 853FH insert tray

Camwear®

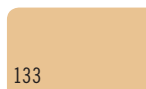

133
Beige

Co-Polymer



161
Tan

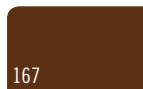

167
Brown

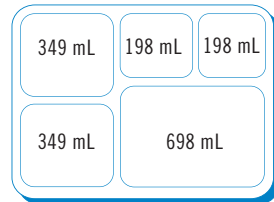

1411CW/1411CP

CODE	DESCRIPTION	DIMENSIONS W x L x D
Camwear		
1411CW	Compartments	26,8 x 36,5 x 3,3 cm
Co-Polymer - BPA FREE		
1411CP	Compartments	26,8 x 36,5 x 3,3

Case Pack: 24

Insert Tray

- Eight trays efficiently fit on a standard sheet pan or in an 45,5 x 65,5 cm wire rack.

Camwear Color: Beige (133).

Lid Color: Clear (135).

Co-Polymer Colors: Brown (167), Tan (161).

Lid Color: Translucent (190).

Heat Resistant Plastic Tray and Lid Color: Amber (150).

Co-Polymer is not NSF Listed.

Not for use in heated carts.



Camwear

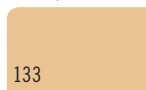

133
Beige

Co-Polymer

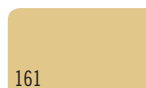

161
Tan



167
Brown

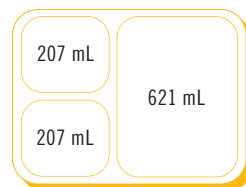

853FCW/853FCP/853FH

Heat Resistant Plastic

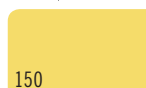

150
Amber

CODE	DESCRIPTION	DIMENSIONS W x L x D
Camwear		
853FCW	Compartments	16 x 22,1 x 4,8 cm
853FCWC	Lid for 853FCW	17,1 x 22,4 x 0,6
Co-Polymer		
853FCP	Compartments	16 x 22,1 x 4,8
853FCPC	Lid for 853FCP	17,1 x 22,4 x 0,6
Heat Resistant Plastic		
853FH	Compartments	16 x 22,1 x 4,8
853FHC	Lid for 853FH	17,1 x 22,4 x 0,6

Case Pack: 24

COMPARTMENT SERVING TRAYS

- For cafeteria-style feeding in high security environments.
- Compartment configurations designed to meet all menu requirements.
- Trapezoid Compartment Trays space saving for self serve correctional facility feeding.

Camwear 6-Compartment Colors: Navy (186), Cranberry (416), Yellow (145), Sherwood Green (119), Beige (133), Black (110).
7 & 5-Compartment Color: Beige (133).
Co-Polymer Color: Tan (161).

 14105CP is not NSF Listed.

 Trapezoid Compartment Trays are covered by the following U.S. Patent D 508,634.



Camwear®



Co-Polymer



NT9CP Co-Polymer Cup:
 For details contact your Cambro representative.



10146CW

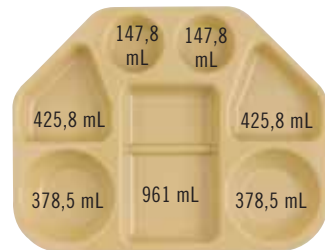

14187TRCW

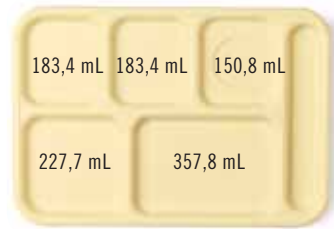

10146CW

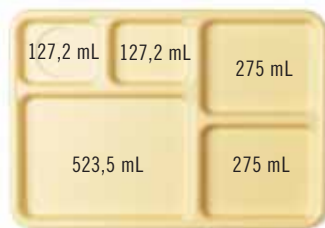

10145CW



14105CW / 14105CP

CODE	DESCRIPTION	DIMENSIONS W x L x D	CASE PACK
Camwear			
14187TRCW	7 compartments, trapezoid	45,6 x 35,4 x 4 cm	12
10146CW	6 compartments	25,4 x 36,8 x 2,4	24
14105CW	5 compartments	27,2 x 35,2 x 2,9	24
10145CW	5 compartments	25,4 x 36,8 x 2,4	24
Co-Polymer - BPA FREE			
14105CP	5 compartments	27,2 x 35,2 x 2,9	24

MARKET TRAYS AND PANS

SPECIFICATIONS

Material	Fiberglass layers + polyester resin
Surface Characteristic	Smooth
Performance	Excellent
Stacking Lugs	Yes
Dishwasher Safe	Yes – Extensive
Chemical Resistance	Good
Drying Test	Excellent
Shock Resistance	Excellent
Break Resistance	Good
Scratch Resistance	Good
Stain Resistance	Excellent
Heat Resistance	-10° to +100°C‡

‡Not for use in heated carts.

RECOMMENDED USE

Moderate Traffic /
 Economic Priority
 – Deli / Buffet Displays

Colors: Yellow (145)**, Blue (142), Green (140), White (148), Black (110).

*Special order item not carried in stock – non-returnable.

**NSF listed for non-direct food contact only.

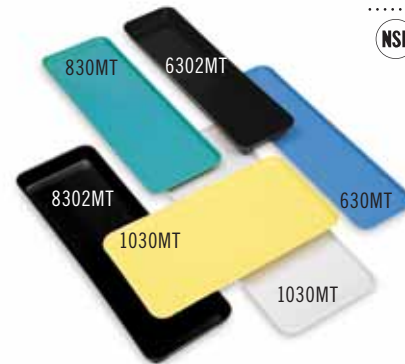

CODE	DIMENSIONS W x L x D	CASE PACK
Market Trays		
630MT*	16,4 x 76,2 x 1,9 cm	12
826MT*	21,6 x 64,1 x 1,9	12
830MT*	21,4 x 76,2 x 1,9	12
913MT*	22 x 31,6 x 2,1	12
918MT*	22 x 45,7 x 2,1	12
926MT*	22,5 x 64,9 x 2,5	12
1015MT*	25,7 x 38,1 x 1,9	24
1030MT*	26,5 x 76,2 x 1,9	12
1218MT*	29,2 x 45,1 x 2,5	12
1224MT*	31,6 x 61 x 1,9	12
1230MT*	31,6 x 76,2 x 1,9	12
1318MT*	32,1 x 45,1 x 2,7	12
1826MT*	45,2 x 65,2 x 2,7	6
2025MT*	52,7 x 64,9 x 2,1	6
Market Pans		
6302MT*	16,7 x 76,2 x 5,1	12
8262MT*	21,5 x 64,1 x 5,1	12
8302MT*	21,4 x 76,2 x 5,1	12
92615MT*	22,5 x 64,8 x 3,8	12
10302MT*	26,5 x 76,2 x 5,1	12



healthcare

HEALTHCARE

Camduction® Complete Heat System

Meal Delivery Ware

Reusable CamLids® for Meal Delivery Systems

Disposable CamLids

Camshelving® Hygienic Drying Racks

Tablotherm Meal Delivery System

Antibacterial Camguard® Versa Trays

Polyester Decorated Versa Trays with Non-Slip Surface

Non-Slip Versa Lite Trays

Non-Slip Versa Camtrays®

Camwear® Non-Slip Tray

Camtrays with Handles

Meal Delivery Carts for Tray Service



Why Cambro® Healthcare?

For over 60 years Cambro has been focused on developing innovative solutions to the toughest challenges in the foodservice industry. Cambro Healthcare products are designed to perform consistently under the most demanding conditions of healthcare foodservice.

The Components for Successful Meal Service and Patient Satisfaction

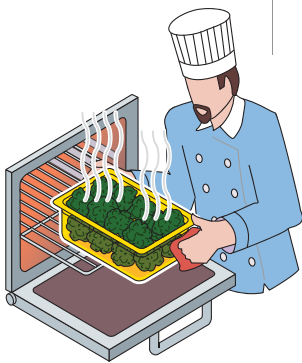
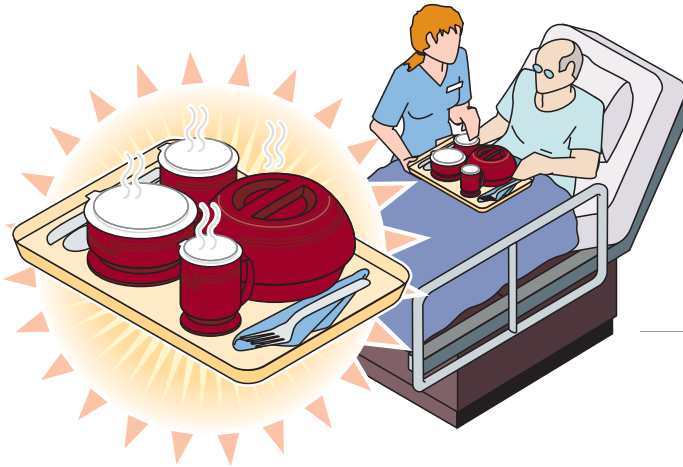

Hot Food

The goal of any meal delivery system is to keep food hot and fresh. Safe food handling and preparation are the first steps.

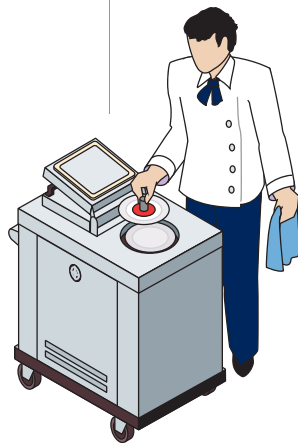

Hot Plate

Hot plate needs a plate heated to 85°-90°C. A plate that is not heated diminishes food quality for patients.

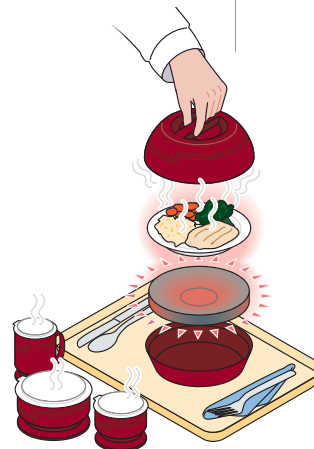

Temperature Maintenance System

Innovative Camduction® heat retention system charges the bases to 75°-85°C fast and efficiently for any facility with a hot tray line system.



Meal Transportation

From meal delivery carts to individual Tablotherm meal transport systems, these products can extend the heat retention of the meal to the patient's bedside.

.....
Tablotherm Pellet System achieves temperature retention of 64°C for 2 hours.

CAMDUCTION® COMPLETE HEAT SYSTEM – HOT MEAL DELIVERY SYSTEM

Camduction innovative hot meal delivery system is fast and efficient. Camduction is perfect for any facility with a hot tray line system. One charger can accommodate up to 300 meals per service.

Camduction Charger covered by U.S. Patent 8,263,906 B2.
 Camduction Base covered by U.S. Patent D630,897 S.

 Camduction Charger comes with 1 year warranty.



Quickly and efficiently heats up to 20 Camduction bases at one time, standard setting takes 5 minutes.

Energy efficient unit turns off after 45 minutes of no activity.

Digital sensors ensure bases stay hot till removed.

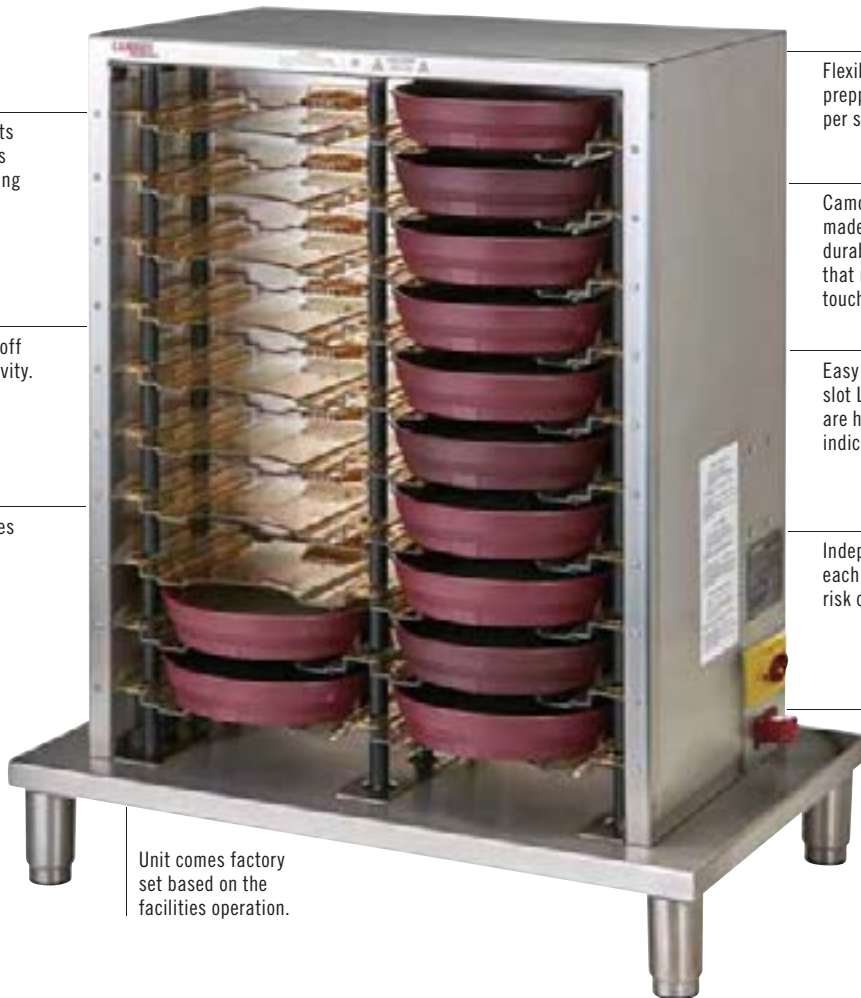

Flexible solution for prepping 20-300 meals per service period.

Camduction charger is made of high-grade, durable stainless steel that remains cool to the touch.

Easy to operate: amber slot LED indicates bases are heating. Green light indicates ready.

Independent functionality of each compartment reduces the risk of service interruption.

Specify cord and plug for country of usage.

Unit comes factory set based on the facilities operation.



Base Charger

CODE	MDSCDC9X5EU24V
DESCRIPTION	Camduction base charger, three phase
CAPACITY	20 Bases
OVERALL DIMENSIONS W x D x H	76,2 x 47,9 x 87,9 cm
VOLTAGE / PHASE	PE AC 380-480V, three phase
AMPS / HERTZ	16, 50/60
PLUG TYPE	Available in multiple plug types
ELECTRICAL CORD	2 m
INITIAL HEAT UP TIME	5 minutes*
ALL INDICATOR LIGHTS	LED
UNIT WEIGHT	52,6 kg
CASE PACK	1

Color: Stainless Steel (000). *A heated Base will be ready for use every 12 seconds (based on voltage supply) when being removed and replaced during meal service.



CAMDUCTION® COMPLETE HEAT SYSTEM – HOT MEAL DELIVERY SYSTEM

- Cool rims are safe to touch.
- Bases are durable and dishwasher safe.
- Resistant to chips, cracks, and breaks.
- Bases and Domes are available in navy blue and cranberry.
- Energy Efficient Unit goes in to heat retention mode. Keeps bases hot and saves energy.

The Results of the Camduction Complete Heat System

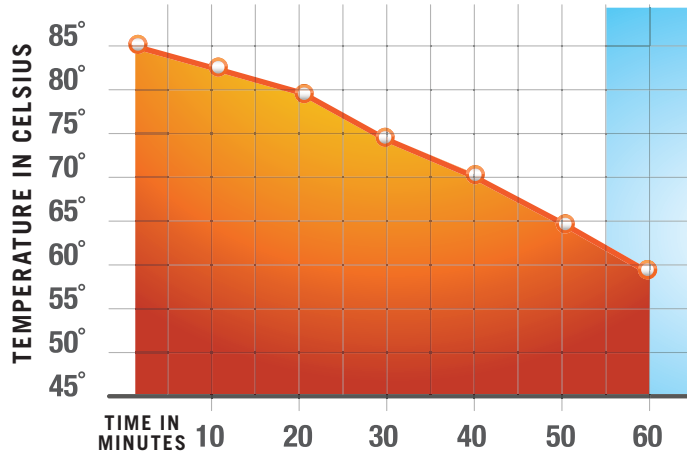

Results based on heated plate between 90°-100°C and hot food at approximately 85°C.

NOTE: Operator results may vary based on menu items and starting temperatures.

The Camduction Base System

A heated Camduction Base, combined with a properly heated 22,8 cm Cambro Ceramic Plate, covered with a Cambro Shoreline Insulated Dome will hold hot food at safe temperatures 65°C or higher for 45 minutes.



2 2 year pro-rated warranty on Bases.



487
Cranberry



497
Navy Blue



Safe to the touch even when fully charged.

TEMPERATURE RETENTION SYSTEMS



Insulated Dome

22,86 cm Ceramic Plate

Camduction® Base

- Camduction Bases are durable and dishwasher safe.
- Resistant to chips, cracks and breaks.
- Revolutionary technology eliminates errors or issues with spikes in voltage.
- 2 year pro-rated warranty on Bases.
- Holds a 22,86 cm plate.

MDS09, MDSL09 and MDCDB9EU24V Colors: Meadow (447), Wheat (457), Speckled Gray (480), Cranberry (487), Navy Blue (497), Black (110).

MDSPLT9 Color: White (148).
MDSPLT9 Sold in full cases only.

MDCDB9EU24V is covered by U.S. Patent D 630, 8975 S. and 8,263,906 B2.



Insulated Dome

22,86 cm Ceramic Plate

Pellet Underliner

Camtherm® Thermal Pellet

- Holds heat at its core to keep hot foods at safe temperatures.
- Stays 11°C cooler on the edge than metal pellets to protect staff and patients from burns.
- Is a high-density plastic composite that won't dent like metal pellets.
- Holds a 22,86 cm plate.

MDS09, MDSL09 and MDCDB9EU24V Colors: Meadow (447), Wheat (457), Speckled Gray (480), Cranberry (487), Navy Blue (497), Black (110).

MDSP9 Color: Dark Gray (477).
MDSP9 for use with CHPDL80.

MDSPLT9 Color: White (148).
MDSPLT9 Sold in full cases only.

MDSL9 and MDSP9 are NSF listed.



Insulated Dome

22,86 cm Ceramic Plate

Heat Keeper Insulating Base

- Maintains heat for at least 20 minutes.
- Cost-effective solution to maintain meal delivery temperatures.
- Resists stains, odors and scratches.
- Holds a 22,86 cm plate.

MDS09, MDSL09 and HK39B Colors: Meadow (447), Wheat (457), Speckled Gray (480), Cranberry (487), Navy Blue (497), Black (110).

MDSPLT9 Color: White (148).
MDSPLT9 Sold in full cases only.

HK39B is NSF listed.



Insulated Dome

22,86 cm Ceramic Plate

Camchiller® Cold Pellet

- Shatter-resistant at freezing temperature.
- Stackable for easy transport and storage.
- Fits 22,86 cm plate, Cambro® 22,86 cm plate cover and insulated dome.
- Can be used with or without an underliner.

MDS09 and MDSL9 Colors: Meadow (447), Wheat (457), Speckled Gray (480), Cranberry (487), Navy Blue (497), Black (110).

MDSPC9 Color: Black (110).

MDSPLT9 Color: White (148).
MDSPLT9 Sold in full cases only.



MEAL DELIVERY WARE SYSTEM – THE HARBOR COLLECTION

- Attractive design provides a pleasant dining experience.
- Supports temperature maintenance.
- Available in six popular colors to complement any decor.
- Mugs and bowls fit existing line of Cambro disposable CamLids® for Shoreline Collection.
- Made of polypropylene, won't chip or break.
- High temperature dishwasher safe.
- Dome fits 22,86 cm plate.
- Industry's only NSF listed insulated ware line.

Domes and delivery ware are not designed for microwave use.

Insulated Harbor bowl is covered by U.S. Patent D795,017 S.



CODE	MDSHD9	MDSHB5	MDSHB9	MDSHM8
DESCRIPTION	Insulated dome covers 22,86 cm plate	Insulated small bowl	Insulated large bowl	Insulated mug
LID CODE	—	CLSM8B5, CLRSM8B5	CLSB9, CLRSB9	CLSSM8B5, CLSM8B5, CLRSM8B5
APPROX. CAPACITY	—	150 mL	270 mL	240 mL
OUTSIDE DIAMETER	25,94 cm	8,89 cm	11,11 cm	11,43 cm
HEIGHT	8,17 cm	6,1 cm	6,1 cm	10,16 cm
CASE PACK	12	48	48	48

Harbor Meal Delivery Ware Colors:



MEAL DELIVERY WARE SYSTEM – SHORELINE COLLECTION

- Classic design, high performance, and unequalled safety at a budget-friendly price.
- Works with all Cambro Temperature Retention Systems: Camduction® Complete Heat System, Camtherm® Thermal Pellet System and the Heat Keeper Insulating Base System.
- Mugs and bowls fit Cambro® disposable CamLids®.
- Industry's only NSF listed ware line.
- Domes and delivery ware are made of durable polypropylene.

Domes and delivery ware are not designed for microwave use.



STOCK PRODUCTS & COLORS AVAILABLE IN OUR EUROPEAN WAREHOUSES

MDSM8, MDSB5, MDSB9: (487), (497), (110)
MDSB16: (480), (487), (497), (110)



Black (110)



Meadow (447)



Wheat (457)



Speckled Gray (480)



Cranberry (487)



Navy Blue (497)



Insulated Accessories



CODE	MDSM8*	MDSB5	MDSB9	MDSB16	MDSPL**
DESCRIPTION	Insulated mug	Insulated sm. Bowl	Insulated lg. Bowl	Insulated entree bowl	Pellet lifter
APPROX. CAPACITY	240 mL	150 mL	270 mL	500 mL	—
OUTSIDE DIAMETER	8,89 cm	8,89 cm	11,11 cm	13,65 cm	8 cm
HEIGHT	10,16 cm	6,1 cm	6,1 cm	6,1 cm	7,6 cm
FULL-SIZE CAMRACK®	16C414	16C414	9S318	9S318	—
CASE PACK	48	48	48	48	1

*MDSM8 Diameter 11,43 cm with Handle. MDSPL Color: (000). **MDSPL is not NSF listed.

The Shoreline Collection Colors:

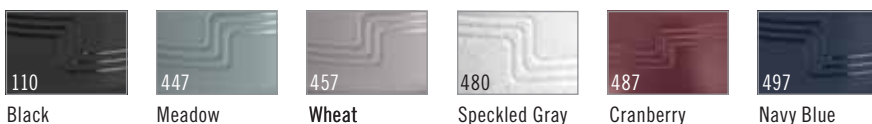

Safely lift hot, thermal pellets or plates with the Cambro Pellet Lifter.

MEAL DELIVERY WARE – THE SHORELINE COLLECTION

Camduction® Complete Heat System

The most efficient heat retention solution, holds hot food at safe temperatures 60°C or higher for 45 minutes.

**STOCK PRODUCTS & COLORS AVAILABLE
IN OUR EUROPEAN WAREHOUSE**

MDSL9, MDSL9: (487), (497), (110)
MDS9: (487), (497) MDS9: (477) MDSPL9: (000)

	 MDS9 	 MDSL9 	 MDSPL9	 MDCDB9EU24V 
CODE	MDS9	MDSL9	MDSPL9	MDCDB9EU24V
DESCRIPTION	Insulated dome covers 22,86 cm plate	Low profile insulated dome covers 22,86 cm plate	Ceramic plate	Camduction base holds 22,86 cm plate
OUTSIDE DIAMETER	25,94 cm	25,94 cm	22,86 cm	24,31 cm
HEIGHT	8,17 cm	6,99 cm	2,54 cm	2,26 cm
FULL-SIZE CAMRACK®	PR59314	PR59314	PR314	PR59314
CASE PACK	12	12	24	12

Camtherm® Thermal Pellet System





The perfect choice for maximum heat retention, holds temperature for 60 or more minutes.

Domes and Delivery Ware are made of durable polypropylene and not designed for microwave use.

	 MDS9 	 MDSL9 	 MDSL9 	 MDSPL9	 MDSP9 
CODE	MDS9	MDSL9	MDSL9	MDSPL9	MDSP9
DESCRIPTION	Insulated dome covers 22,86 cm plate	Low profile insulated dome covers 22,86 cm plate	Pellet underliner holds 24,13 cm pellet	Ceramic plate	Thermal pellet holds 22,86 cm plate
OUTSIDE DIAMETER	25,94 cm	25,94 cm	24,29 cm	22,86 cm	24 cm
HEIGHT	8,17 cm	6,99 cm	4,6 cm	2,54 cm	4,45 cm
FULL-SIZE CAMRACK	PR59314	PR59314	PR59314	PR314	PR59314
CASE PACK	12	12	12	24	12

Heat Keeper Insulating Base System

The cost-effective solution for heat retention, holds temperature for 20 or more minutes.

	 MDS9 	 MDSL9 	 MDSPL9	 HK39B 
CODE	MDS9	MDSL9	MDSPL9	HK39B
DESCRIPTION	Insulated dome covers 22,86 cm plate	Low profile insulated dome covers 22,86 cm plate	Ceramic plate	Insulating base for 22,86 cm plate
OUTSIDE DIAMETER	25,94 cm	25,94 cm	22,86 cm	24,48 cm
HEIGHT	8,17 cm	6,99 cm	2,54 cm	4,07 cm
FULL-SIZE CAMRACK	PR59314	PR59314	PR314	PR59314
CASE PACK	12	12	24	12

Camchiller® Cold Pellet System

Keeps cold food below or at 4°C for up to 45 minutes when used with a chilled plate and insulated dome.

	 MDS9 	 909CW 	 MDSPL9	 new! MDSPC9 	 MDSL9 
CODE	MDS9	909CW	MDSPL9	MDSPC9	MDSL9
DESCRIPTION	Insulated dome covers 22,86 cm plate	Camwear® Camcover®	Ceramic plate	Camchiller cold pellet holds 22,86 cm plate	Pellet underliner holds 24,13 cm pellet
OUTSIDE DIAMETER	25,94 cm	26,2 cm	22,86 cm	24,31 cm	24,29 cm
HEIGHT	8,17 cm	6,99 cm	2,54 cm	3,42 cm	4,6 cm
FULL-SIZE CAMRACK	PR59314	PR59314	PR314	PR59314	PR59314
CASE PACK	12	12	24	12	12

REUSABLE CAMLIDS® FOR MEAL DELIVERY SYSTEMS

- Save up to 75% in lid costs each year.
- Reduce your waste-stream significantly each year when you switch from disposables to reusables.
- Dishwasher safe.
- Made of durable polypropylene.
- Fits both Shoreline and Harbor Collection mugs and bowls.
- Contact your Cambro Sales Representative for a Customized Savings Calculator!

Reusable CamLid Color:
Speckled White (490).
.....
Camrack Wash and Store Rack Color:
Kelly Green (452).
.....
Camrack Base Full Size Color:
Soft Grey (151).
.....

Full Rack Cover Color: Grey (180).
.....
CLRWSR36 is covered under U.S. patent D 617,069.
.....
Full Rack Cover not NSF certified.
.....



STOCK PRODUCTS & COLORS AVAILABLE IN OUR EUROPEAN WAREHOUSE

CLRSB9, CLRSM8B5, CLRSB16: (490)
CLRWSR36: (452)
BR578: (110), (163), (167), (168), (184), (186), (414), (416), (119), (151)
DRC2020: (180)
E3: (151)
CRPHDG2878: (000)

Visit www.cambro.com/savemoney for a Customized Savings Calculator!



Camrack® Wash and Store Rack

- Designed for safe and secure washing and storing of Reusable CamLids, CLRSB9 and CLRSM8B5 only.
- Each Camrack Wash and Store Rack holds 36 Reusable CamLids.
- 2 Wash and store Racks fit in a Full Size Base Rack.



CODE	DESCRIPTION	DIMENSIONS	CASE PACK
Reusable CamLids			
CLRSM8B5	Fits 240 mL mug and 150 mL bowl	H x Dia. 0,71 x 9,05 cm	240
CLRSB9	Fits 270 mL bowl	0,71 x 11,32	240
CLRSB16	Fits 500 mL bowl	0,71 x 13,97	240
Accessories for CLRSM8B5 and CLRSB9			
CLRWSR36	Camrack wash and store rack to wash 36 reusable lids	L x W x H 20,96 x 45,4 x 13,97	4
BR578	Camrack full size base rack with 2 extenders	50 x 50 x 18,4	4
DRC2020	Full rack cover	50 x 50 x 2,4	1
Accessories for CLRSB16			
PR500	9 x 9 peg rack with 1 extender	L x W x H 50,17 x 50,17 x 14,29	5
E3	Full size open extender	50,17 x 50,17 x 2	12
CRPHDG2878	Full size square hold down grid	46,67 x 46,67	6

Reusable CamLids sold in cases only. No broken cartons.

DISPOSABLE CAMLIDS® FOR SHORELINE

MADE OF HIGH IMPACT POLYSTYRENE (H.I.P.S.)



LID CODE	CLSM8B5	CLSB9	CLSSM8B5
DESCRIPTION	Sm. disp. lid	Lg. disp. lid	Disp. sip. lid
FITS	MDSB5, MDSM8	MDSB9	MDSB5, MDSM8
OUTSIDE DIAMETER	9,1 cm	11,28 cm	9,1 cm
HEIGHT	0,76 cm	0,76 cm	1,9 cm
CASE PACK	1,500	1,000	1,000

CLSM8B5, CLSB9 Color: Translucent (190). CLSSM8B5 Color: White (148).
Sold in full cases only. No broken cartons.



The 177 & 266 mL Lido tumblers are marked with 59 mL increments from the top down for easy patient liquid intake recording.

Disposable Lids for Laguna® Tumblers



LID CODE	CLLT6	CLLT10	CLLT12
FITS TUMBLERS	LT6	LT10	LT12
TUMBLER CAPACITY	177,4 mL	295,7 mL	354,9 mL
CASE PACK	1,500	1,000	1,000

Color: Translucent (190). Sold in full cases only. No broken cartons.

Disposable Lid for Swirl Bowls



LID CODE	CLSRB5
FITS SWIRL BOWLS	SRB5CW / SRB5
SWIRL BOWL CAPACITY	148 mL
CASE PACK	1,000

Color: Clear (152). Made of (P.E.T.).
Sold in full cases only. No broken cartons.

Disposable Lids for Colorware Tumblers



LID CODE	CLJ6	New! CL800P	CL900P	CL950P
FITS TUMBLERS	500P / 500P2	800P	900P / 900P2	950P / 950P2
TUMBLER CAPACITY	154 mL	236,6 mL	287 mL	290 mL
CASE PACK	1,000	1,000	1,000	1,000

Color: Translucent (190). Sold in full cases only. No broken cartons.

Disposable Lids for Lido® Tumblers



LID CODE	CLST6	CL900P
FITS TUMBLERS	LDT6	LDT9
TUMBLER CAPACITY	177 mL	266 mL
CASE PACK	1,000	1,000

Color: Translucent (190).
Sold in full cases only. No broken cartons.

Disposable Lids for Newport Tumblers



LID CODE	CLNT5	CLNT8	New! CLNT9	CLNT10	CLNT12
FITS TUMBLERS	NT5	NT8	NT9	NT10	NT12
TUMBLER CAPACITY	189 mL	228 mL	266 mL	300 mL	373 mL
CASE PACK	1,500	1,000	1,000	1,000	1,000

Color: Translucent (190). Sold in full cases only. No broken cartons.

CAMSHELVING® HYGIENIC DRYING RACKS



- Keep tray line and warewashing areas organized and prevent wet stacking by storing newly washed products upright for faster drying before storing.
- Non-corrosive, break resistant and easy to assemble.
- Mobile racks allow for easy floor clean up and maneuverability.
- Drying Cradles are removable and available separately to convert existing units to Drying Racks.
- Lifetime warranty against rust and corrosion on posts and traverses.
- Drying Cradles are made of high impact ABS material.

***Camshelving Premium Series Color:**
Speckled Gray (480).
****Camshelving Elements Series Color:**
Brushed Graphite (580).
*****Drying Cradle Color:** Soft Gray (151).
.....
Casters:
4 Premium Casters: (2 swivel with total locking brake, 2 swivel with no brake).
.....



Vertical Drying and Storage Rack

- Securely holds various sizes of trays, cutting boards, baking sheet pans, lids and plates 20,5 to 34,3 cm.
- Drying Cradles are installed directly onto shelf traverses.
- Fits 610 mm shelves.

7-Slot Drying Cradle is covered by U.S. Patent D 663,912 S.



COMPONENT



CSDR7
7-Slot Drying Cradle
Width Per Slot: 3,3 cm

STOCK PRODUCTS & COLORS AVAILABLE IN OUR EUROPEAN WAREHOUSE

CSDR7, CSDR73: (151)
MPMU61117DRPKG, MPMU61317DRPKG: (490)



MPMU61117DRPKG
Camshelving Premium



EMU244878DRPKG
Camshelving Elements

CODE	DESCRIPTION	DIMENSIONS D x L x H	HOLDING CAPACITY	CASE PACK
Camshelving Premium*				
MPMU61117DRPKG	Vertical drying rack	600 x 1180 x 1790 mm	84 Trays	1
MPMU61317DRPKG	Vertical drying rack	600 x 1380 x 1790	105	1
Camshelving Elements**				
EMU244878DRPKG	Vertical drying rack	610 x 1220 x 1980	84	1
EMU246078DRPKG	Vertical drying rack	610 x 1530 x 1980	105	1
Drying Cradles***				
CSDR7	7-Slot drying cradle	597 x 260 x 95	—	1
CSDR73	7-Slot drying cradle	597 x 260 x 95	—	3

Camshelving Premium: Units ship complete with 2 mobile post kits, 6 traverses, 12 or 15 vertical drying cradles and premium swivel casters with total locking brake. Assembly required. **Camshelving Elements:** Units ship complete with factory assembled mobile post kits, 6 mobile shelf traverses, mobile shelf traverse dovetails, 12 or 15 vertical drying cradles and premium swivel casters with total locking brake. Assembly required.

CAMSHELVING® HYGIENIC DRYING RACKS

Angled Drying and Storage Rack

- Securely holds up to 128 meal delivery Pellets/Bases or a variety of food pan sizes, pots and kitchen wares.
- Drying Cradles are installed directly onto shelf traverses.
- Fits 610 mm shelves.

8-Slot Drying Cradle is covered by U.S. Patent D739,989 S.



COMPONENT

STOCK PRODUCTS & COLORS AVAILABLE IN OUR EUROPEAN WAREHOUSE

CSDR8, CSDR84: (151)
MPMU61217PDPKG: (490)



CSDR8
8-Slot Drying Cradle
Width Per Slot: 6 cm



MPMU61217PDPKG
Camshelving Premium

CODE	DESCRIPTION	DIMENSIONS D x L x H	HOLDING CAPACITY	CASE PACK
Camshelving Premium*				
MPMU61217PDPKG	Angled drying rack	600 x 1280 x 1790 mm	128 pellets and bases or 16 GN 1/1 food pans	1
Camshelving Elements**				
EMU244878PDPKG	Angled drying rack	610 x 1220 x 1980	128 pellets and bases or 16 GN 1/1 food pans	1
Drying Cradles***				
CSDR8	8-Slot drying cradle	592 x 263 x 160	—	1
CSDR84	8-Slot drying cradle	592 x 263 x 160	—	4

Camshelving Premium: Units ship complete with 2 mobile post kits, 8 traverses, 16 angled drying cradles and premium swivel casters with total locking brake. Assembly required. **Camshelving Elements:** Unit ships complete with factory assembled mobile post kits, 8 mobile shelf traverses, mobile shelf traverse dovetails, 16 angled drying cradles and premium swivel casters with total locking brake. Assembly required.



EMU244878PDPKG
Camshelving Elements

Dome Drying and Storage Rack

- Securely holds 100 meal delivery domes.
- Drying Cradles are installed directly onto shelf traverses.
- Fits 540 mm shelves.

10-Slot Drying Cradle is covered by U.S. Patent D 736,488 S.



COMPONENT



CSDDC
10-Slot Drying Cradle
Width Per Slot: 7,8 cm



CPMU213675DDPKG
Camshelving Premium

CODE	DESCRIPTION	DIMENSIONS D x L x H	HOLDING CAPACITY	CASE PACK
Camshelving Premium*				
CPMU213675DDPKG	Dome drying rack	540 x 910 x 1910 mm	100 Domes	1
Drying Cradles***				
CSDDC	10-Slot drying cradle	520 x 415 x 86	—	1
CSDDC5	10-Slot drying cradle	520 x 415 x 86	—	5

Individual Dome Drying Cradles fit on Camshelving Premium and Camshelving Elements Series 540 mm deep shelves only. **Package Includes:** Pre-assembled mobile post kits, 10 traverses, 10 drying cradles and premium swivel casters with total locking brake. Assembly required. **Fits only Camshelving Premium Series made in the USA. Special Order. Allow 10 to 12 weeks for delivery for International delivery.**

TABLOTHERM CAM GOBOX® MEAL DELIVERY SYSTEM

The Tablotherm Cam GoBox is the cost-effective solution for delivering single-served meals. This lightweight insulated tray separates hot and cold foods, keeping meals at safe temperatures for up to 60 minutes. Extra compartments can be used for beverages and snacks for a convenient and complete meal delivery.

Lids 122601118, 122600021 and 122600023 are BPA Free.
.....

New!



Excellent insulation and temperature retention.

Made of expanded polypropylene.

Maintains hot and cold foods safe in one unit for up to 60 minutes.

Stackable, lightweight individual meal delivery system for easy transportation and storage.

TABLOTHERM CAM GOBOX® MEAL DELIVERY SYSTEM



ITENEPP
EPP Tablotherm without dishes
EXTERIOR DIM. L x W x H:
37 x 53 x 11,8 cm
UNIT WEIGHT: 0,55 kg
Case Pack: 1 **Color:** Grey (107).



ITENEPP118
EPP Tablotherm with dishes -
2 rectangular dishes 11 x 18 cm,
2 bowls 14 cm, reusable covers
EXTERIOR DIM. L x W x H:
37 x 53 x 11,8 cm
UNIT WEIGHT: 2,53 kg
Case Pack: 1 **Color:** Grey (107).



ITENEPP21
EPP Tablotherm with dishes - 1 plate
21 cm, 2 bowls 14 cm, reusable
covers
EXTERIOR DIM. L x W x H:
37 x 53 x 11,8 cm
UNIT WEIGHT: 2,27 kg
Case Pack: 1 **Color:** Grey (107).



ITENEPP23
EPP Tablotherm with dishes -
1 two-compartment plate 23 cm,
2 bowls 14 cm, reusable covers
EXTERIOR DIM. L x W x H:
37 x 53 x 11,8 cm
UNIT WEIGHT: 2,32 kg
Case Pack: 1 **Color:** Grey (107).



ITENEPP118H
EPP Tablotherm with dishes - 2
rectangular dishes 11 x 18 cm, 2
Shoreline bowls MDSB16 (13,6 cm)
(500 mL), 2 reusable covers CLRSB16
EXTERIOR DIM. L x W x H:
37 x 53 x 11,8 cm
UNIT WEIGHT: 1,82 kg
Case Pack: 1 **Color:** Grey (107).



ITENEPP21H
EPP Tablotherm with dishes - 1 plate
21 cm, 2 Shoreline bowls MDSB16
(13,6 cm) (500 mL), 2 reusable
covers CLRSB16
EXTERIOR DIM. L x W x H:
37 x 53 x 11,8 cm
UNIT WEIGHT: 1,57 kg
Case Pack: 1 **Color:** Grey (107).



ITENEPP23H
EPP Tablotherm with dishes - 1
two-compartment plate 23 cm, 2
Shoreline bowls MDSB16 (13,6 cm)
(500 mL), 2 reusable covers CLRSB16
EXTERIOR DIM. L x W x H:
37 x 53 x 11,8 cm
UNIT WEIGHT: 1,62 kg
Case Pack: 1 **Color:** Grey (107).

STOCK PRODUCTS & COLORS AVAILABLE IN OUR EUROPEAN WAREHOUSE

All TABLOTHERM CAM GOBOXES: (107)
122401118, 122601118, 122400021,
122600021, 122400023, 122600023,
122500014, 122700014: (000)
MDSB16: (480)

Ceramicware



CODE	122401118	122601118	122400021	122600021	122400023	122600023	122500014	122700014	MDSB16
DESCRIPTION	Porcelain rectangular dish	Rectangular dish cover for 122400018	Porcelain plate	Plate cover for 122400021	2-compartment porcelain plate	Plate cover for 122400023	Porcelain bowl 14 cm	Bowl cover	Insulated Shoreline bowl - 500 mL
EXTERIOR DIM. (CM)	11 x 18	11 x 18	Ø 21	Ø 21,5	Ø 23	Ø 23,5	Ø 14 x 0,7	Ø 14,5	Ø 13,6 x 6
UNIT WEIGHT (KG)	0,45	0,06	0,58	0,18	0,6	0,2	0,44	0,04	0,13
Case Pack:	1 Color: (000).								

TABLOTHERM MEAL DELIVERY SYSTEM

The ideal single-serve meal delivery system for in-home service

- Transport and serve hot and cold food in one complete unit.
- Maintain safe food temperatures for over 1 hour.
- Lightweight design makes transportation easy and convenient.
- Two sizes accommodate a variety of meal options.
- Dishwasher safe.



Tablotherms stack for easy transportation and storage.

Molded-in dimples secure the sealed lids on dishware to prevent spills and enhance temperature retention.

Break-resistant china dishware.

Compact design makes transport easy.



Safely hold hot and cold meals in one unit.



Meal set-up is convenient with Tablotherm trays and dishes.



Tablotherms are designed for dining comfort.

TABLOTERM INSULATED TRAYS

SPECIFICATIONS

Material	Polypropylene + Foam Insulation
Characteristic	Insulated Tray
Performance	Excellent
Heat Retention	Approximately 60 Minutes*
Dishwasher Safe	Yes
Stackable	Yes
Minimum Food & Plate Temperature before Plating	85° - 90°C
Individual Dish Cover	Yes – Prevent Spilling of Soup and Sauces



*With heated pellet.
Not for use in heated carts.



ITPD3253 - Gastronorm size



ITPD3753T - Euronorm size

ITPD3253 model with Heated Pellet	85°C	80°C	77°C	74°C	71°C
ITPD3253 model without Heated Pellet	85°C	72°C	68°C	64°C	—
ITPD3753T model with Heated Pellet	89°C	75°C	70°C	65°C	62°C
ITPD3753T model without Heated Pellet	87°C	67°C	60°C	—	—



Only available from Cambro European Logistics (CEL), Germany.

STOCK PRODUCTS & COLORS AVAILABLE IN OUR EUROPEAN WAREHOUSE

IT3253, IT3753T, ITPD3253, ITPD3753T, 112 430 000, 122 400 050, 122 450 050, 122 500 050, 122 600 050, 122 650 050, 122 700 050, 122 201 050, 122 200 050, 122 260 050: (000)
165PW: (A42)



Light gray polypropylene lid with integrated rubber seal. Lids cannot be used in microwave oven.

For a complete guide to maximizing heat retention, contact your Cambro representative.

CODE	DESCRIPTION	DIMENSIONS W x L x H
Tablotherm – Insulated Tray with Porcelain Dishes, seal covers and pellet		
ITPD3753T	Euronorm insulated tray including: 1 ea. two-compartment plate (122 400 050), 1 ea. reusable cover (122 600 050), 1 ea. Pellet (165PW), 3 ea. multi-purpose bowls: 2 ea. 400 mL (122 500 050), 1 ea. 500 mL (122 450 050) and 3 ea. reusable covers: 2 ea. (122 700 050) and 1 ea. (122 650 050)	37 x 53 x 10,5 cm
ITPD3253	Gastronorm insulated tray including: 1 ea. two-compartment plate (122 400 050), 1 ea. reusable cover (122 600 050), 1 ea. pellet (165PW) 2 ea. multi-purpose bowl (122 500 050) and 2 ea. reusable cover (122 700 050)	32,5 x 48 x 10,5
Tablotherm – Insulated Tray without porcelain dishes, seal covers and pellet		
IT3753T	Euronorm insulated tray – empty	37 x 53 x 10,5
IT3253	Gastronorm insulated tray – empty	32,5 x 48 x 10,5
Porcelain dishes		
122 400 050	Two compartment plate. Outside ø 254 mm capacity 750 mL (white)	—
122 450 050	Multi-purpose bowl. Outside ø 142,2 mm capacity 500 mL (white)	—
122 500 050	Multi-purpose bowl. Outside ø 120 mm capacity 400 mL (white)	—
Reusable polypropylene covers, light gray with integrated rubber seal		
122 600 050	For two compartment plate	—
122 650 050	For multi-purpose bowl – 500 mL	—
122 700 050	For multi-purpose bowl – 400 mL	—
Pellet System		
165PW	SMC pellet ø 16,5 cm	—
Menu card		
112 430 000	Yellow menu cards 100 x 70 mm	—
Latches		
122 201 050	Latches with menu card holder (IT3253, ITPD3253)	—
122 200 050	Latches without menu card holder (IT3253, ITPD3253)	—
122 260 050	Latches and screw kit: 1 ea. latch, 4 ea. screws (IT3753T, ITPD3753T)	—

ITPD3753T, IT3753T Color: Gray and Blue. ITPD3253, IT3253 Color: Two Tone Gray. 165PW Color: (A42). 165PW Case Pack: 1 Each.

ANTIMICROBIAL CAMGUARD® VERSA TRAYS

- High performance polyester tray for ultra-intensive use.
- Built-in antibacterial protection eliminates bacteria between tray washings and will not wash off or wear away for the life of the tray.
- Reinforced polyester corners provide superior corner and edge protection against impact.
- Stacking lugs allow air circulation for fast drying and perfect stacking.
- Temperature range resistance from -40° to 140°C. ‡
- Dishwasher safe – Wash as often and as frequently as needed.

‡ Not for use in heated carts.



Minimum quantity order from CEL:
Non-stock item 240 pieces.
No broken carton.

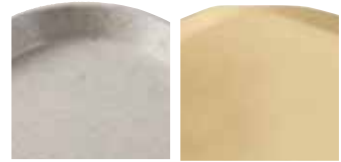

High Profile Shape Low Profile Design Shape



Flat Edge Shape



camguard

ANTIMICROBIAL TRAYS

Trays have built-in antimicrobial properties to protect against mildew growth and bacterial odors. This protection will not wash or wear off.

Unprotected Surface versus Camguard Protected Surface 24 Hour Test.

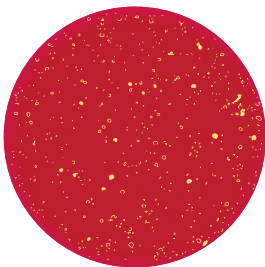

Unprotected

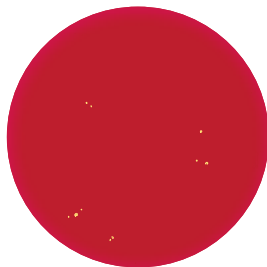

Protected with Camguard

CODE

DIMENSIONS

Versa Trays – High Profile Shape

VT1418AB	35,5 x 45,7 cm
VT3343AB	33 x 43

Versa Century™ Trays – Low Profile Design Shape

VT3646CAB	35,5 x 45,7
VT3343CAB	32,9 x 42,9

Versa Trays – Flat Edge Shape

GP1070AB*	26,5 x 32,5
GP1080AB*	26,5 x 37
GP3980AB*	37 x 53
GP4002AB*	32,5 x 53

Case Pack: 12

*Designed with reinforced corners for automatic off-stacking onto conveyor belt dishwashers.



Innovative low profile and low corner design increases space utilization of tray surface and customer comfort while eating.



Reinforced polyester corners provide superior corner and edge protection against impact.



Stacking lugs keep trays stacked securely in place and ensure proper air flow.

Tray Color:



A83
Granite

POLYESTER DECORATED VERSA TRAYS WITH NON-SLIP SURFACE

- Reduce waste, save money and provide a stable tray surface for meal delivery.
- Switching from paper tray mats will generate annual savings of over 50%.
- Your Green Initiatives will get rapid results with the elimination of up to 10 tons of trash each year.
- High performance polyester tray for ultra-intensive use.
- Reinforced polyester corners provide superior corner and edge protection against impact.
- Stacking lugs allow air circulation for fast drying and perfect stacking.
- Temperature range resistance from -40° to 80°C.‡
- Dishwasher safe – Wash as often and as frequently as needed.

‡ Not for use in heated carts.

Personalization: Contact your Cambro representative for pricing.



Flat Edge Shape

STOCK PRODUCTS & COLORS AVAILABLE IN OUR EUROPEAN WAREHOUSE

GP4002NS: (B93)

Minimum quantity order from CEL:
Stock item one case, Non-stock item 120 pieces. No broken carton.



CODE	DIA/ SIZE	CASE PACK
Versa Trays – Flat Edge Shape		
GP3980NS*	37 x 53 cm	12
GP4002NS*	32,5 x 53	12
GP0540NS*	34,4 x 46	12
GP1080NS*	26,5 x 37	12

*Designed with reinforced corners for automatic off-stacking onto conveyor belt dishwashers.



Non-Slip Trays grip firmly providing safer meal delivery service.

Patterns and Tray Base Colors:

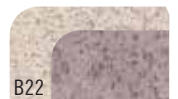

B22
Sahara on Sahara Tray



B93
Titan on Granite Tray



B31
Lava on Speckled Blue Tray



B99
Pebbled Black on Light Grey Tray



B100
Pebbled Black on Terrazzo Tray

POLYESTER NON-SLIP VERSA LITE TRAYS

- Non-Slip surface provides a better grip for safer meal delivery.
- Reduce your environmental waste-stream each year when you switch from paper tray mats to Non-Slip Versa Lite Trays.
- Standard performance polyester tray for intensive use.
- Reinforced polyester corners provide superior corner and edge protection against impact.
- Stacking lugs allow air circulation for fast drying and perfect stacking.
- Temperature range resistance from -40° to 80°C.‡
- Dishwasher safe – Wash up to 3 times per day.

Colors: Sahara on Sahara Tray (B22), Titan on Speckled Smoke Tray (B14), Sahara on Pearl White Tray (B11), Pebbled Black on Light Grey Tray (B99).

Personalization: Contact your Cambro representative for pricing.

‡ Not for use in heated carts.



STOCK PRODUCTS & COLORS AVAILABLE IN OUR EUROPEAN WAREHOUSE

GL4002NS: (B22)

Minimum quantity order from CEL: Stock item one case, Non-stock item 120 pieces. No broken carton.



High Profile Shape



Low Profile Design Shape



Flat Edge Shape



Versa Lite Century Trays have low edges and ergonomic corners that enhance comfort.



Stacking lugs keep trays stacked securely in place and ensure proper air flow.



Reinforced polyester corners provide superior corner and edge protection against impact.

Tray Colors:



B22

Sahara on Sahara Tray



B14

Titan on Speckled Smoke Tray



B11

Sahara on Pearl White Tray



B99

Pebbled Black on Light Grey Tray

CODE	DIMENSIONS
Versa Lite Trays – High Profile Shape	
VL1418NS	35,5 x 45,7 cm
VL3343NS	33 x 43
Versa Lite Century™ Trays – Low Profile Design Shape	
VL3646CNS	35,5 x 45,7
VL3343CNS	33 x 43
Versa Lite Trays – Flat Edge Shape	
GL3980NS*	37 x 53
GL4002NS*	32,5 x 53

Case Pack: 12

*Designed with reinforced corners for automatic off-stacking onto conveyor belt dishwashers.



Non-Slip Trays grip firmly providing safer meal delivery service.

NON-SLIP VERSA CAMTRAYS®

- Non-Slip Trays reduce waste, save money and provide a stable tray surface for meal delivery.
- Switching from paper tray mats will generate annual savings of over 50%.
- Green Initiatives will get rapid results with the elimination of tons of trash each year.
- Non-Slip Camtrays provide a better grip for safer meal delivery.
- Dishwasher safe in low and high temperatures.
- Stacking lugs keep trays in place and ensure proper airflow between trays.
- Temperature range resistance from -40° to 80°C.‡

Camtray and Dietary Tray Colors:
Black with Pebbled Black (382),
Pearl Gray with Titan (381),
Ivory with Sahara (380).

Personalization: Contact your Cambro representative for pricing.

‡ Not recommended for heated carts.

NSF Listed for non-direct food contact only.



Non-Slip trays grip table top items firmly.

CODE	DESCRIPTION	DIMENSIONS
1418VC	Non-Slip Versa Camtray	35,5 x 45,7 cm
1520VC	Non-Slip Versa Camtray	38 x 51

Case Pack: 12

NON-SLIP VERSA CAMTRAYS FOR ROOM SERVICE

- Ergonomic handles allow for safe and elegant meal delivery.
- Trays fit within existing meal delivery carts that accommodate 35,5 x 45,7 or 38 x 51 cm trays.
- Non-Slip surface eliminates the need for tray mats saving time and money.
- Dishwasher safe at high and low temperatures.
- Stacking lugs allow for quick drying.
- Temperature range resistance from -40° to 80°C.‡
- 38 x 51 cm tray is ideal for room service.

Room Service Tray Colors:
Black with Pebbled Black (382),
Pearl Gray with Titan (381),
Ivory with Sahara (380).

Personalization: Contact your Cambro representative for pricing.

‡ Not recommended for heated carts.

Non-Slip Versa Camtrays for Room Service is covered by U.S. Patent D 683,191 S.

NSF Listed for non-direct food contact only.



High Profile Shape Flat Edge Shape



Black with Pebbled Black (382)

Pearl Gray with Titan (381)

Ivory with Sahara (380)

CODE	DESCRIPTION	DIMENSIONS
1418VCH	Non-Slip Versa Camtray with handles	35,5 x 45,7 cm
1520VCRST	Non-Slip Versa Camtray with handles	38 x 51

Case Pack: 12



CAMWEAR® NON-SLIP TRAY

- Ideal for healthcare patient meal delivery and in high-traffic cafeterias.
- Scratch-resistant, made of durable Camwear.
- Non-Slip eliminates the need for tray mats, saving time and money.
- Enhances stability, providing safer transport and service.
- Stacking lugs keep trays in place and ensure proper airflow between trays.
- Commercial dishwasher safe at high and low temperatures.
- Trays with handles are also available without non-slip surface.

Colors: Black (110), Dark Cranberry (488), Smoked Metal (485).

*Not recommended for use in heated carts.

NSF Listed for non-direct food contact only.



Black (110)

Dark Cranberry (488)

Smoked Metal (485)



1520CWNS

CODE	DESCRIPTION	DIMENSIONS
Non-Slip		
1418CWNS	Camwear non-slip tray	35,5 x 45,7 cm
1520CWNS	Camwear non-slip tray	38 x 51
1418CWNSH* New!	Camwear non-slip tray with handles	35,5 x 45,7
1520CWNSH* New!	Camwear non-slip tray with handles	38 x 51
Without Non-Slip		
1418CWH New!	Camwear tray with Handles	35,5 x 45,7
1520CWH New!	Camwear tray with Handles	38 x 51

Case Pack: 12



1520CWNSH

STOCK PRODUCTS & COLORS AVAILABLE IN OUR EUROPEAN WAREHOUSE

1418CWNS: (488)

CAMTRAYS® WITH HANDLES

- Enhance your tray presentation with these easy-to-grip, ergonomic, contoured handles.
- Stain, Scratch and odor resistant.
- Made of durable lightweight and high-impact fiberglass.
- Stacking lugs keep trays in place and ensure proper airflow between trays.
- Dishwasher safe at high and low temperatures.

Available in Group I colors.

Special order item not carried in stock, non-returnable. One case order minimum.

NSF listed for non-direct food contact only.

Personalization through digital printing process only. Please refer to Camtray Personalization section for details.



1520H

STOCK PRODUCTS & COLORS AVAILABLE IN OUR EUROPEAN WAREHOUSE

1418H: (110), (199), (538)

CODE	DESCRIPTION	DIMENSIONS
1418H	Camtray with handles	35,5 x 45,7 cm
1520H	Camtray with handles	38 x 51

Case Pack: 12

MEAL DELIVERY CARTS FOR TRAY SERVICE

- Transport meal trays from the kitchen to acute care patients, nursing home residents or correctional facility inmates.
- Enhance patient satisfaction with high quality, room service style meals served quietly and efficiently.
- Tough, one-piece, double-wall polyethylene carts are easy to clean and won't rust, dent, crack, chip or break.
- Non-electric and requires no assembly.
- Features light-weight non-insulated ABS doors.
- Features four total locking quiet, non-marking nylon casters (2 rigid, 2 swivel with brake). MDC1411T60 comes standard with plated casters.
- NSF listed.

Single door 10-Tray Meal Delivery Cart is covered by U.S. Patent D 723,237 S.



10-TRAY DUAL ACCESS ROOM SERVICE CART – LOW PROFILE



Large, molded-in ergonomic handle makes it easy to transport and maneuver.

Molded-in marine rail provides an additional tray landing surface. Marine rail is designed for use during service, not transport.



Center opening provides self-venting airflow, optimizing food quality and humidity.

Molded-in rails ensure quiet meal delivery, rail spacing 13,34 cm.

Holds up to ten 38 x 51 cm or Euronorm 37 x 53 cm trays.



Total locking quiet casters lock both swivel motion and wheel.

Polyurethane insulation ensures quiet meal delivery and provides structural strength.

Durable, lightweight, self-venting, ABS doors are non-insulated and open a full 270°, providing ergonomic access to trays from both the front and back of the cart.

Molded-in full-perimeter bottom bumper protects the cart, walls and furniture.

STOCK PRODUCTS & COLORS AVAILABLE IN OUR EUROPEAN WAREHOUSE

MDC1520S10D: (191)



Menu clip holds routing directions or content lists.

CODE	MDC1520S10D
TRAY SIZE	38 x 51 / 37 x 53 cm
TRAYS PER COMPARTMENT/ RAIL SPACING	5 / 13,3 cm
EXTERNAL DIMENSIONS W x D x H	77,5 x 97,5 x 109 cm
INTERNAL DIMENSIONS W x D x H	53,6 x 78,7 x 66,6 cm
CASTER TYPE	Nylon, 12,7 cm 2 rigid, 2 swivel with brake
UNIT WEIGHT	42 kg

Case Pack: 1 Colors: Granite Gray (191), Granite Sand (194).



AIRPOT AND CONDIMENT STATION

- Holds three airpots for safe transport and service.
- Compartments are designed for stir sticks, napkins and a variety of condiments.
- Stain and odor resistant.
- Made of durable ABS material.

BSACS patent pending.



CODE	DIMENSIONS W x D x H	CASE PACK
BSACS	59 x 39 x 15,2 cm	1

Color: Black (110). Airpots not included.

10-TRAY SINGLE DOOR ROOM SERVICE CART – LOW PROFILE



One louvered vent on the back supports air circulation.

Large, molded-in ergonomic handle makes it easy to transport and maneuver.

Molded-in marine rail creates additional work surface during service. Marine rail is designed for use during service, not transport.



Polyurethane insulation ensures quiet meal delivery and provides structural strength.

Molded-in full-perimeter bottom bumper protects the cart, walls & furniture.

Molded-in rails ensure quiet meal delivery, rail spacing up to 13,34 cm.



Menu clip holds routing directions or content lists.

Lightweight, self-venting, ABS door is non-insulated and opens a full 270°.

Shown with four, 13 cm non-marking, offset, durable stainless steel casters (2 fixed and 2 swivel with brake). Heavy duty casters are available.

CODE	MDC1520S10	MDC1520S10HD
TRAY SIZE	38 x 51,5 cm & 37 x 53 cm	38 x 51,5 cm & 37 x 53 cm
TRAYS PER RAIL / RAIL SPACING	2 / 13,3 cm	2 / 13,3 cm
EXTERNAL DIMENSIONS W x D x H	77,5 x 97,5 x 109 cm	77,5 x 97,5 x 110,5 cm
INTERNAL DIMENSIONS W x D x H	53,7 x 78,7 x 66,7 cm	53,7 x 78,7 x 66,7 cm
CASTER TYPE	Nylon, standard casters 12,7 x 3,2 cm	Nylon, heavy duty casters 15,2 x 5,1 cm
UNIT WEIGHT	35,4 kg	40,8 kg

Case Pack: 1 Colors: Granite Gray (191), Granite Sand (194).

20-TRAY MEAL DELIVERY CART – LOW PROFILE



Colors: Slate Blue (401), Granite Grey (191), Granite Green (192), Granite Sand (194).
(All carts with cream door.)

MDC1520T16 and MDC1418T16 are covered by U.S. Patent D 398,727.



Marine rail is designed for use during service, not transport.



MDC1520S20
Back view with louvered vents



Low Profile

CODE	MDC1520S20	MDC1418S20
TRAY SIZE	38 x 51,5 cm	36 x 46 cm
TRAYS PER CART	20	20
TRAYS PER COMPARTMENT	10	10
RAILS PER COMPARTMENT	5	5
TRAYS PER RAIL	2	2
RAIL SPACING	13,9 cm	13,9 cm
NUMBER OF DOORS	2	2
NUMBER OF COMPARTMENTS AND VENTS	2	2
NUMBER OF MENU CLIPS	2	2
MENU CLIPS - LOCATION	1 per door	1 per door
HANDLES - TYPE AND LOCATION	Molded in, each end	Molded in, each end
CASTER TYPE	Nylon, 15,2 cm, 2 swivel w/brake, 2 rigid, offset	Nylon, 12,7 cm, 2 swivel w/brake, 2 rigid, offset
LATCHES	2 internal nylon friction	2 internal nylon friction
EXTERNAL DIMENSIONS W x L x H	96,5 x 140 x 112,4 cm	82,6 x 123,2 x 111,8 cm
INTERNAL DIMENSIONS W x D x H	53,5 x 77 x 70 cm	47 x 71,5 x 74 cm
UNIT WEIGHT	70,31 kg	64,18 kg

Case Pack: 1

16 AND 30 TRAY MEAL DELIVERY CARTS – TALL PROFILE



Marine rail is designed for use during service, not transport.



Tall Profile

SPECIFICATIONS	MDC1520T30	MDC1520T16	MDC1418T30	MDC1418T16
TRAY SIZE	38 x 51,5 cm	38 x 51,5 cm	36 x 46 cm	36 x 46 cm
TRAYS PER CART	30	16	30	16
TRAYS PER COMPARTMENT	10	8	10	8
RAILS PER COMPARTMENT	10	4	10	4
TRAYS PER RAIL	1	2	1	2
RAIL SPACING	12,7 cm	13,3 cm	12,7 cm	13,3 cm
NUMBER OF DOORS	3	1	3	1
NUMBER OF COMPARTMENTS	3	2	3	2
NUMBER OF MENU CLIPS	5	1	5	1
MENU CLIPS - LOCATION	Each door, each end	Back of cart	Each door, each end	Back of cart
HANDLES - TYPE AND LOCATION	Heavy-duty nylon, mounted 1 per end	Molded-in, 1 per end	Heavy-duty nylon, mounted 1 per end	Molded-in, 1 per end
CASTER TYPE	Nylon, 15,2 cm, 2 rigid, 4 swivel w/brake, offset	Nylon, 15,2 cm, 2 rigid, 4 swivel w/brake	Nylon, 15,2 cm, 2 rigid, 4 swivel w/brake, offset	Nylon, 15,2 cm, 2 rigid, 2 swivel w/brake
LATCHES	Friction catch, Transit latch*	Large paddle latch external security latches	Friction catch, transit latch*	Large paddle latch
EXTERNAL DIMENSIONS W x L x H	74,3 x 152,4 x 161,6 cm	99,4 x 77,8 x 147,6 cm	74,3 x 152,4 x 161,6 cm	92,7 x 71,1 x 147,6 cm
INTERNAL DIMENSIONS W x D x H	39 x 53,34 x 127 cm	52,5 x 55 x 77,5 cm	37 x 55 x 127 cm	46,5 x 55 x 74,6 cm
REQUIRED DOOR WIDTH	77 cm	79 cm	77 cm	73 cm
UNIT WEIGHT	95,25 kg	62,37 kg	97,07 kg	54,88 kg

Case Pack: 1 Colors: Slate Blue (401), Granite Grey (191), Granite Green (192), Granite Sand (194). (All carts with cream door.)

*Stainless steel transit latch at top of each door. MDC1520T16 and MDC1418T16 are covered by U.S. Patent D 398,727.

For lighter-duty applications, 30-tray carts may be ordered without the steel transit latches by using product code MDC1520T30NL or MDC1418T30NL.

60-TRAY MEAL DELIVERY CART FOR CORRECTIONAL TRAY SERVICE

- For use in correctional facilities.
- Holds 60 each 1411CW or 1411CP Cambro Base Trays with 853 Insert Trays or 60 each 10146DCW or 10146DCP Separator Compartment Trays.
- Security features include security screws on handles, stop locks on door knuckles, security bolts for transit latches and caster carriage bolts with lock nuts.



1411CP base tray with 853FH insert tray

CODE	MDC1411T60
TRAY SIZE	36,5 x 26,8 cm base tray 1411CW and 1411CP
TRAYS PER CART	60
TRAYS PER COMPARTMENT	20
RAILS PER COMPARTMENT	10
TRAYS PER RAIL	2
RAIL SPACING	12,7 cm
NUMBER OF COMPARTMENTS	3
MENU CLIPS	None
HANDLES - TYPE AND LOCATION	Heavy-duty aluminum with security screws, black finish, 1 per end
CASTER TYPE	Nylon, 15,2 cm heavy-duty casters, 5 cm wide tread, 2 swivel with brake, 2 rigid
LATCHES	Internal friction catch, 2 per door, transit latch***
EXTERNAL DIMENSIONS W x L x H	74,3 x 152,4 x 161,6 cm
INTERNAL DIMENSIONS W x D x H	37 x 55 x 127 cm
REQUIRED DOOR WIDTH	76,2 cm
UNIT WEIGHT	97,98 kg

Case Pack: 1 Colors: Slate Blue (401), Granite Grey (191), Granite Green (192), Granite Sand (194). ***Stainless steel transit latch at top of each door.

MEAL DELIVERY CARTS FEATURES AND CASTER CONFIGURATIONS

Standard Caster Configurations:

These caster configurations are designed to provide stability and maneuverability over uneven surfaces.

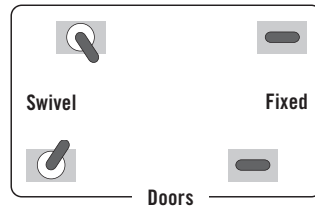

MDC1520S20, MDC1418S20, MDC1411T60



MDC1520S10*, MDC1520T16, MDC1418T16

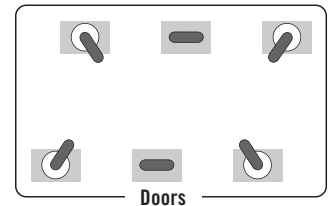

MDC1520T30, MDC1418T30

Optional Caster Configurations*:

These caster configuration options are alternative designs if facility or environment requires the need to change.

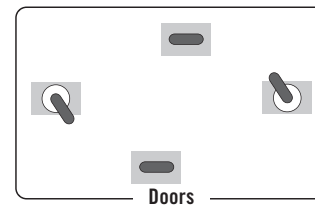

MDC1520S20, MDC1418S20

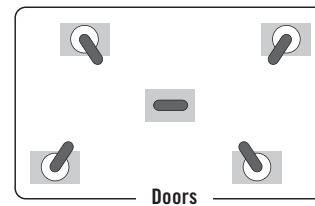

MDC1520S20, MDC1418S20, MDC1520T30, MDC1418T30, MDC1411T60

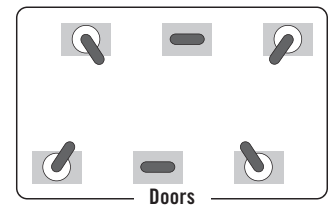

MDC1520S20, MDC1418S20, MDC1411T60

*All optional caster configurations are special order items and therefore non-returnable.

Handles

MDC1520S20, MDC1418S20



Molded in handles on each end for smooth transporting.

MDC1520T16, MDC1418T16



Molded in handles for easy transporting.

MDC1520T30, MDC1418T30, MDC1411T60**



Heavy duty nylon handles are securely mounted and nested into each end. **MDC1411T60 has tamper resistant heavy duty aluminum tubing handles.

LEAD IN CASTERS



Castors are offset to ease movement over uneven surfaces. This is standard on MDC1520S10, MDC1520S20, MDC1418S20, MDC1520T30, MDC1418T30 and MDC1411T60.

ALPHA NUMERICAL LISTING

CODE	PAGE	CODE	PAGE	CODE	PAGE	CODE	PAGE
1000	219	10HPCH	161	1219D (Group 3)	224	1411CP	239
1000 (Group 3)	219	10HPCHN	161	122 200 050	257	1411CW	239
1000CW	173	10HPD	157	122 201 050	257	1418	218
1000LCD	33	10HPD	159	122 260 050	257	1418 (Group 3)	218
1000LCDCVR	33	10HS1114	66	122 400 050	257	14187TRCW	240
1005CW	173	10HS318	66	122 450 050	257	1418CL	224
1007CW	173	10HS434	66	122 500 050	257	1418CT	226
100BC	51	10HS638	66	122 600 050	257	1418CW	225
100BC1	51	10HS800	66	122 650 050	257	1418CWH	225
100BCS	51	10HS958	66	122 700 050	257	1418CWH	262
100CW	172	10PPCH	164	1220D	224	1418CWNS	225
100LCD	33, 35	10PPCWSC	155	1220D (Group 3)	224	1418CWNS	262
100MCCW	169	10PPCWSC	164	1222D	224	1418CWNSH	225
100MPC	13	10PPD	164	1222D (Group 3)	224	1418CWNSH	262
100MPCHL	13	1100	219	122400021	255	1418D	224
100VS	173	1100 (Group 3)	219	122400023	255	1418D (Group 3)	224
1010VS	173	1100CT	226	122401118	255	1418FF	235
1012VS	173	1101CW	173	1224MT	240	1418H	220, 262
1013CW	173	1116	218	122500014	255	1418TR	219
1014	218	1116 (Group 3)	218	122600021	255	1418TR (Group 3)	219
1014 (Group 3)	218	112 430 000	257	122600023	255	1418TRCW	225
10145CW	240	1120CBP	84	122601118	255	1418VC (Group 3)	223
10146CW	236, 240	1120CBR	84	122700014	255	1418VC (Group 3)	261
10146DCP	238	116VS	173	1230MT	240	1418VCH (Group 3)	223
10146DCPC	238	1200	219	124VS	173	1418VCH (Group 3)	261
10146DCW	238	1200 (Group 3)	219	1252SLB250	166	1422TR	219
10146DCWC	238	1200CW	182	1252SLINB250	166	1422TR (Group 3)	219
1014CL	224	1200DIV	14, 21	12CW	153	14CW	153
1014CT	226	1200P	181	12HP	159	14HP	159
1014FF	235	1200P2	181	12HP772	157	14HP772	157
1014VS	173	1202CW	173	12HPH	162	14PP	164
1015	218	120CWP	172	12PP	164	150CW	172
1015 (Group 3)	218	120VS	173	12RS12	51	1520	218
1015MT	240	1210PW	14, 17, 18, 19, 21	12SFSCW	142	1520 (Group 3)	218
10302MT	240	1216	218	12SFSP	143	1520BCP	84
1030MT	240	1216 (Group 3)	218	12SFSP	143	1520CBP	84
103VS	173	1216CL	224	12TGS	194	1520CBPF	84
105VS	173	1216CT	226	1300	219	1520CBR	84
106VS	173	1216D	224	1300 (Group 3)	219	1520CL	224
10CW	172	1216D (Group 3)	224	1313	218, 220	1520CT	226
10CWC	155	1216FF	235	1313 (Group 3)	218, 220	1520CW	225
10CWCH	155	1217FFH	235	1318	218	1520CWH	225, 262
10CWCHN	155	12183CW	150	1318 (Group 3)	218	1520CWNS	225, 262
10CWD	153	12183P	151	1318CC	37	1520CWNSH	225, 262
10CWGL	155	12186CW	150	1318MT	240	1520D	224
10CWGL	161	12186P	151	13CLRCW	154	1520D (Group 3)	224
10CWL	172	12189CW	150	13CLRHP	160	1520H	220, 262
10CWNR	172	12189P	151	1400	219	1520TR	219
10HC258	67	1218CCW	150	1400 (Group 3)	219	1520TR (Group 3)	219
10HC258	71	1218CP	151	1400CT	226	1520VC (Group 3)	223, 261
10HC414	67	1218DSCW	151	1400ET	228	1520VCRST (Group 3)	223, 261
10HE1	72	1218MT	240	1400TL	227	1550	219
10HE2	72	1218SCCW	150	14105CP	240	1550 (Group 3)	219
10HPC	161	1219D	224	14105CW	240	1550CT	226

ALPHA NUMERICAL LISTING

CODE	PAGE	CODE	PAGE	CODE	PAGE	CODE	PAGE
2SFSP	143	350LCD	33	44PP	164	62PP	164
2SFSP	143	35CLRCW	154	45CW	172	6302MT	240
300DIV	14, 21	35CLRHP	160	46	218	630MT	240
3046	220	35CLRPP	163	46 (Group 3)	218	63CLRCW	154
3046 (Group 3)	220	35CW	172	46CW	153	63CLRHP	160
30CFC	165	36CF	165	46HP	159	63CLRPP	163
30CWC	155	36CW	153	46HP772	157	64CW	153
30CWCH	155	36E1	71	46PP	164	64HP	159
30CWCHN	155	36E2	72	49E1	71	64HP772	157
30CWD	153	36E4	72	49E2	72	64PP	164
30CWGL	155, 161	36E5	72	49S1114	65	65OWS	54
30CWL	155	36HP	159	49S318	65	65CLRCW	154
30CWLN	155	36HP772	157	49S434	65	65CLRHP	160
30GE1	71	36PP	164	49S638	65	65CLRPP	163
30GE2	72	36S1058	65	49S800	65	65CWNR	172
30HPC	161	36S1114	65	49S958	65	66CF	165
30HPCH	161	36S1214	65	4FBRTT	43	66CW	153
30HPCHN	161	36S318	65	4SFSCW	142	66HP	159
30HPD	157, 159	36S418	65	4SFSP	143	66HP772	157
30HPL	161	36S434	65	4SFSP	143	66PP	164
30HPLN	161	36S534	65	500CW	182	68VS	173
30PPCH	164	36S638	65	500LCD	33	6F	190
30PPCHN	164	36S738	65	500LCDCVR	33	6FBRTT	43
30PPCWSC	155, 164	36S800	65	500P	177, 181	6RS6	51
30PPD	164	36S900	65	500P2	177, 181	6SFSCW	142
30S1114	64	36S958	65	50CW	172	6SFSP	143
30S318	64	3753	220	50MCCW	169	6SFSP	143
30S434	64	3753 (Group 3)	220	5412CBP	35, 51	6TGS	194
30S638	64	3853	220	55CWNR	172	725CWNR	172
30S800	64	3853 (Group 3)	220	57	218	730SR	54
30S958	64	38CW	153	57 (Group 3)	218	730STP	49
3200P2	181	38PP	164	5FBRTT	43	730WS	54
3242	220	400DIV	14, 18, 19, 21	60CFC	165	75CW	172
3242 (Group 3)	220	400MCCW	169	60CW	172	800CW	182
3253	220	400STP	18, 19, 24, 77	60CWC	155	800P	177, 181
3253 (Group 3)	220	40CWC	155	60CWCH	155	800P2	181
3253CL	224	40CWCH	155	60CWCHN	155	806CW	173
3253CT	226	40CWCHN	155	60CWD	153	80CWC	155
32CC	181	40CWD	153	60CWGL	155, 161	80CWCH	155
32CW	153	40HPC	161	60CWL	155	80CWCHN	155
32HP	159	40HPCH	161	60CWLN	155	80CWD	153
32HP1H	162	40HPCHN	161	60HPC	161	80HPC	161
32HP2H	162	40HPD	157, 159	60HPCH	161	80HPCH	161
32HP772	157	40PPCH	164	60HPCHN	161	80HPCHN	161
32PP	164	40PPCWSC	155, 164	60HPD	157, 159	80HPD	157, 159
3343	220	40PPD	164	60HPL	161	80PPCWSC	155
3343 (Group 3)	220	415CBP	84	60HPLN	161	810	218
33CLRCW	154	42CW	153	60PPCH	164	810 (Group 3)	218
33CLRHP	160	42HP	159	60PPCHN	164	825CWNR	172
33CLRPP	163	42HP772	157	60PPCWSC	155, 164	8262MT	240
34CW	153	42PP	164	60PPD	164	826MT	240
34HP	159	44CW	153	62CW	153	82CW	153
34HP772	157	44HP	159	62HP	159	82HP	159
34PP	164	44HP772	157	62HP772	157	82HP772	157

ALPHA NUMERICAL LISTING

CODE	PAGE	CODE	PAGE	CODE	PAGE	CODE	PAGE
8302MT	240	9113CP	238	9S800	63	BR578	69, 250
830MT	240	9113CW	238	9S958	63	BR712	69
84CW	153	9114CP	238	9TGS	194	BSACS	264
84HP	159	9114CW	238	ADC33	81	BSB10	190
84HP772	157	911CPC	238	ADCS	80	BSB12	190
850CW	182	911CWC	238	BAR540	59	BSB18	190
853FCP	239	911VS	173	BAR540DS	59	BUF48	43
853FCPC	239	912CBP	84	BAR54SR	54	BUF72	43
853FCW	239	913MT	240	BAR650	59	BV6CW	184
853FCWC	239	913VS	173	BAR650CP	59	BWB16CW	176
853FH	239	915	218	BAR650DS	59	BWM10CW	176
853FHC	239	915 (Group 3)	218	BAR650DSCP	59	BWP14CW	176
85SFVS	173	915CP	237	BAR650SDX	58	BWW10CW	176
86CW	153	915CW	237	BAR650SPM	58	CA1300	233
86HP	159	918MT	240	BAR650SPMT	58	CA1623	233
86HP772	157	91VS	173	BAR650SPMT2	58	CA2026	233
86VS	173	926	218	BAR650DX	58	CA2028	233
8F	190	926 (Group 3)	218	BAR650PM	58	CA2129	233
8FB434	70	92615MT	240	BAR650PMT	58	CA2632	233
8FBNH434	70	926MT	240	BAR650PMT220	58	CA2738	233
8HC258	67, 71	92CW	153	BAR730	57	CA2836	233
8HC414	67	92HP	159	BAR730CP	57	CA3200	233
8HE1	72	92HP772	157	BAR730DS	57	CA3244	233
8HE2	72	92PP	164	BAR730DSCP	57	CA3247TR	233
8HS1114	66	93CW	172	BAR730SDX	56	CA3253	233
8HS318	66	94CW	153	BAR730SPM	56	CA3343	233
8HS434	66	94HP	159	BAR730SPMT	56	CA3446	233
8HS638	66	94HP772	157	BAR730SPMT2	56	CA3646	233
8HS800	66	94PP	164	BAR730DX	56	CA3748	233
8HS958	66	950CW	177, 182	BAR730PM	56	CA3753	233
8RS8	51	950P	177, 181	BAR730PMT	56	CA3800	233
8SFSCW	142	950P2	177, 184	BAR730PMT220	56	CA3952	233
8SFSP	143	95VS	173	BBR480	43	CA4064H	232
8SFSPP	143	96CW	172	BBR720	43	CA4300	233
900	219	96PCW	153	BC1115SH	86	CA4361	233
900 (Group 3)	219	96PHP	159	BC11TC	86	CB1220	46, 47, 49
900CT	226	96SKRC	195	BC225	86	CBA183064V4	130
900CW	173	96SKRD	195	BC2254S	86	CBA183072V4	130
900P	177, 181	96SKRLC	195	BC230	86	CBA183084V5	131
900P2	177, 181	96SKRLD	195	BC2304S	86	CBA183664V4	130
9011CW	173	96SKRLM	195	BC235	86	CBA183672V4	130
9013CW	173	96SKRLP	195	BC2354S	86	CBA183684V5	131
901CW	173	96SKRM	195	BC330	86	CBA184264V4	130
905CW	173	96SKRP	195	BC3304S	86	CBA184272V4	130
909CW	173, 249	978SFVS	173	BC331KD	85	CBA184284V5	131
90CWC	155	99VS	173	BC331KDSH	85	CBA184864V4	130
90CWCN	155	9CWNR	172	BC331KDTC	85	CBA184872V4	130
90CWD	153	9E1	71	BC340KD	85	CBA184884V5	131
90HPC	161	9E2	72	BC340KDP	85	CBA185464V4	130
90HPD	157, 159	9RS9	51	BCT1014	236	CBA185472V4	130
90PPC	164	9S1114	63	BK60406	36	CBA185484V5	131
90PPCWSC	155, 164	9S318	63	BK60407	36	CBA186064V4	130
90PPD	164	9S434	63	BR258	69, 71	CBA186072V4	130
90SPCW	172	9S638	63	BR414	69	CBA186084V5	131

ALPHA NUMERICAL LISTING

CODE	PAGE	CODE	PAGE	CODE	PAGE	CODE	PAGE
CBA213064V4	130	CBTR542PK	131	CBU246064V4	130	CECMG6	74
CBA213072V4	130	CBTR60	131	CBU246072V4	130	CECMT6	74
CBA213084V5	131	CBTR602PK	131	CBU246084V5	131	CECOF6	74
CBA213664V4	130	CBU183064V4	130	CC32	168	CECPI6	74
CBA213672V4	130	CBU183072V4	130	CCP12	192	CECPO6	74
CBA213684V5	131	CBU183084V5	131	CCP15	192	CECRF6	74
CBA214264V4	130	CBU183664V4	130	CCP27	192	CECRT6	74
CBA214272V4	130	CBU183672V4	130	CCPL12	192	CECRW6	74
CBA214284V5	131	CBU183684V5	131	CCPL27	192	CECSB6	74
CBA214864V4	130	CBU184264V4	130	CD100	76	CECSG6	74
CBA214872V4	130	CBU184272V4	130	CD100H	76	CECSH6	74
CBA214884V5	131	CBU184284V5	131	CD100HB	76	CECWF6	74
CBA215464V4	130	CBU184864V4	130	CD1313	77	CECWI6	74
CBA215472V4	130	CBU184872V4	130	CD1327	77	CECWT6	74
CBA215484V5	131	CBU184884V5	131	CD1420	77	CECWW6	74
CBA216064V4	130	CBU185464V4	130	CD160	76	CFPFRC10	165
CBA216072V4	130	CBU185472V4	130	CD1826H	75	CFPMRC10	165
CBA216084V5	131	CBU185484V5	131	CD1826HB	75	CFPSRC10	165
CBA243064V4	130	CBU186064V4	130	CD1826MTC	76	CFR18	165
CBA243072V4	130	CBU186072V4	130	CD1826MTCB	76	CFRC18	165
CBA243084V5	131	CBU186084V5	131	CD1826PDB	75	CFRSC18	165
CBA243664V4	130	CBU213064V4	130	CD1826PDB	167	CJ80CW	195
CBA243672V4	130	CBU213072V4	130	CD2020	75	CL800P	177, 251
CBA243684V5	131	CBU213084V5	131	CD2020H	75	CL900P	177, 251
CBA244264V4	130	CBU213664V4	130	CD2020HB	75	CL950P	177, 251
CBA244272V4	130	CBU213672V4	130	CD2028	77	CLAM8B5	177
CBA244284V5	131	CBU213684V5	131	CD300	17, 36, 76	CLJ6	177, 251
CBA244864V4	130	CBU214264V4	130	CD300H	76	CLLT10	177, 251
CBA244872V4	130	CBU214272V4	130	CD300HB	76	CLLT12	177, 251
CBA244884V5	131	CBU214284V5	131	CD3253EPP	8	CLLT6	177, 251
CBA245464V4	130	CBU214864V4	130	CD400	18, 24, 76	CLLT8	177
CBA245472V4	130	CBU214872V4	130	CD4060EPP	11	CLNT10	177, 251
CBA245484V5	131	CBU214884V5	131	CDR2020	68, 75	CLNT12	177, 251
CBA246064V4	130	CBU215464V4	130	CDR2020H	68	CLNT5	177, 251
CBA246072V4	130	CBU215472V4	130	CECBE6	74	CLNT8	177, 251
CBA246084V5	131	CBU215484V5	131	CECBL6	74	CLNT9	177, 251
CBCC1	132	CBU216064V4	130	CECBM6	74	CLRSB16	250
CBCC10	132	CBU216072V4	130	CECBR6	74	CLRSB9	250
CBCC8	132	CBU216084V5	131	CECCF6	74	CLRSM8B5	250
CBDS18H10	131	CBU243064V4	130	CECCH6	74	CLRWSR36	250
CBDS18H6	131	CBU243072V4	130	CECCL6	74	CLSB9	251
CBDS21H10	131	CBU243084V5	131	CECCM6	74	CLSM8B5	177, 251
CBDS21H6	131	CBU243664V4	130	CECCO6	74	CLSRB5	183, 251
CBDS24H10	131	CBU243672V4	130	CECCP6	74	CLSSM8B5	251
CBDS24H6	131	CBU243684V5	131	CECCR6	74	CLST6	177, 251
CBID6	132	CBU244264V4	130	CECDC6	74	CLST9	177
CBTR30	131	CBU244272V4	130	CECFL6	74	C02632	230
CBTR36	131	CBU244284V5	131	CECGO6	74	C03200	230
CBTR362PK	131	CBU244864V4	130	CECGR6	74	C03253	230
CBTR42	131	CBU244872V4	130	CECHB6	74	C03343	230
CBTR422PK	131	CBU244884V5	131	CECHU6	74	C03646	230
CBTR48	131	CBU245464V4	130	CECIC6	74	C03753	230
CBTR482PK	131	CBU245472V4	130	CECIT6	74	C03800	230
CBTR54	131	CBU245484V5	131	CECJU6	74	C04300	230

ALPHA NUMERICAL LISTING

CODE	PAGE	CODE	PAGE	CODE	PAGE	CODE	PAGE
CP12	192	D12	180	EA184284V5	119	EA245484V5	119
CP1210	14, 21	D14	177	EA184864V4	118	EA246064V4	118
CP1220	14, 17, 18, 19, 35, 46, 49	D14	180	EA184872V4	118	EA246072V4	118
CP15	192	D16	180	EA184884V5	119	EA246084V5	119
CP2632	8	D24	180	EA185464V4	118	EA247264V4	118
CP27	192	D8	180	EA185472V4	118	EA247272V4	118
CP3253	8, 11, 17, 18, 19, 21	DB18263CW	167	EA185484V5	119	EA247284V5	119
CP6040	36	DB18263P	167	EA186064V4	118	ECC1	121
CP814	14, 46	DB18266CW	167	EA186072V4	118	ECC10	121
CPB1220	42	DBC1826CW	167	EA186084V5	119	ECC8	121
CPFWSC244860	107	DBC1826P	167	EA187264V4	118	EDBA	123
CPH3	42	DC10	186	EA187272V4	118	EDBS	123
CPL12	192	DC1225	83	EA187284V5	119	EDS14H10	121
CPL27	192	DC5	186	EA212464V4	118	EDS14H6	121
CPMU213675DDPKG	109	DC575	83	EA212472V4	118	EDS18H10	121
CPMU213675DDPKG	253	DC700	83	EA212484V5	119	EDS18H6	121
CPMU244867FXPKG	50	DC825	83	EA213064V4	118	EDS21H10	121
CPMU244867SUPKG	107	DCC10	186	EA213072V4	118	EDS21H6	121
CPMU244875PDPKG	253	DCC5	186	EA213084V5	119	EDS24H10	121
CPU244864SUPKG	107	DCS1125	83	EA213664V4	118	EDS24H6	121
CR12	78	DCS950	83	EA213672V4	118	EMCWB	122
CRPHDG2878	69, 250	DD1220BECW	191	EA213684V5	119	EMTR36	124
CSDR7	108, 125, 133, 252	DD1220CW	191	EA214264V4	118	EMTR362PK	124
CSDR73	108, 125, 133, 252	DD1220ECW	191	EA214272V4	118	EMTR42	124
CSDR8	108, 125, 133, 252	DD1220SCW	191	EA214284V5	119	EMTR422PK	124
CSDR84	108, 109, 124, 133, 253	DD1826CW	191	EA214864V4	118	EMTR48	124
CSEQ3	106, 122	DG3CW	176	EA214872V4	118	EMTR482PK	124
CSEQ3	132	DIV12	13, 42, 49	EA214884V5	119	EMTR54	124
CSMHDDDB	122	DIV20	13, 42	EA215464V4	118	EMTR542PK	124
CSMHDTK10	112, 113	DP15	186	EA215472V4	118	EMTR60	124
CSMHDTK12	112, 113	DRC2020	68, 250	EA215484V5	119	EMTR602PK	124
CSMHDTK145	112, 113	DRLNK	135	EA216064V4	118	EMU183670V4	119
CSMHDTKE4	112, 113	DRS30	135	EA216072V4	118	EMU183678V4	119
CSMHDTKE5	112, 113	DRS300	135	EA216084V5	119	EMU184270V4	119
CSMHDTKE6	112, 113	DRS36	135	EA217264V4	118	EMU184278V4	119
CSR3	33	DRS360	135	EA217272V4	118	EMU184870V4	119
CSR5	33	DRS48	135	EA217284V5	119	EMU184878V4	119
CSSC244818	108, 124, 133	DRS480	135	EA242464V4	118	EMU185470V4	119
CSSD188	106, 123, 132	DRS60	135	EA242472V4	118	EMU185478V4	119
CSSD218	106, 123, 132	DRS600	135	EA242484V5	119	EMU186070V4	119
CSSD248	106, 123, 132	DSPR6	183	EA243064V4	118	EMU186078V4	119
CSTSR	107, 123, 132	DT1220CW	191	EA243072V4	118	EMU213670V4	119
CSWF	105, 122, 132	E3	72, 250	EA243084V5	119	EMU213678V4	119
CSWS1436SK	134	EA182464V4	118	EA243664V4	118	EMU214270V4	119
CSWS1436VK	134	EA182472V4	118	EA243672V4	118	EMU214278V4	119
CSWS1448SK	134	EA182484V5	119	EA243684V5	119	EMU214870V4	119
CSWS1448VK	134	EA183064V4	118	EA244264V4	118	EMU214878V4	119
CSWS1836SK	134	EA183072V4	118	EA244272V4	118	EMU215470V4	119
CSWS1848SK	134	EA183084V5	119	EA244284V5	119	EMU215478V4	119
CSWS36EK	134	EA183664V4	118	EA244864V4	118	EMU216070V4	119
CSWS48EK	134	EA183672V4	118	EA244872V4	118	EMU216078V4	119
CVC55	48	EA183684V5	119	EA244884V5	119	EMU243670V4	119
CVC72	48	EA184264V4	118	EA245464V4	118	EMU243678V4	119
CVC724	48	EA184272V4	118	EA245472V4	118	EMU244270V4	119

ALPHA NUMERICAL LISTING

CODE	PAGE	CODE	PAGE	CODE	PAGE	CODE	PAGE
EMU244278V4	119	ESU182464V4	118	ESU243664V4	118	GL4701	212
EMU244870FXPKG	50	ESU182472V4	118	ESU243672V4	118	GL4709	212
EMU244870V4	119	ESU182484V5	119	ESU243684V5	119	GP0540	211
EMU244878DRPKG	125	ESU183064V4	118	ESU244264V4	118	GP0540 (Group 3)	209
EMU244878DRPKG	252	ESU183072V4	118	ESU244272V4	118	GP0540NS (Group 3)	209, 259
EMU244878PDPKG	125	ESU183084V5	119	ESU244284V5	119	GP1070	207, 211
EMU244878PDPKG	253	ESU183664V4	118	ESU244864V4	118	GP1070AB	208, 258
EMU244878V4	119	ESU183672V4	118	ESU244872V4	118	GP1080	211
EMU245470V4	119	ESU183684V5	119	ESU244884V5	119	GP1080AB	208, 258
EMU245478V4	119	ESU184264V4	118	ESU245464V4	118	GP1080NS (Group 3)	209, 259
EMU246070V4	119	ESU184272V4	118	ESU245472V4	118	GP3074	211
EMU246078DRPKG	125	ESU184284V5	119	ESU245484V5	119	GP3788	211
EMU246078DRPKG	252	ESU184864V4	118	ESU246064V4	118	GP3980	207, 211
EMU246078V4	119	ESU184872V4	118	ESU246072V4	118	GP3980 (Group 3)	209
EPP160	8	ESU184884V5	119	ESU246084V5	119	GP3980AB	208, 258
EPP180	8	ESU185464V4	118	ESU247264V4	118	GP3980NS (Group 3)	209, 259
EPP180PKG	8	ESU185472V4	118	ESU247272V4	118	GP4002	207, 211
EPP180S	8	ESU185484V5	119	ESU247284V5	119	GP4002 (Group 3)	209
EPP180SPKG	8	ESU186064V4	118	ETR24	124	GP4002AB	208, 258
EPP260	8	ESU186072V4	118	ETR30	124	GP4002NS (Group 3)	209, 259
EPP280	8	ESU186084V5	119	ETR36	124	GP4004	207, 211
EPP300	8	ESU187264V4	118	ETR362PK	124	GP4004 (Group 3)	209
EPP3253DIV	8	ESU187272V4	118	ETR42	124	GP4210	211
EPP400	8	ESU187284V5	119	ETR422PK	124	GP4410	211
EPP4060F6R	11	ESU212464V4	118	ETR48	124	GP4701	211
EPP4060F9R	11	ESU212472V4	118	ETR482PK	124	GP4709	211
EPP4060FADJR	11	ESU212484V5	119	ETR54	124	GP4853	211
EPP4060FAR	11	ESU213064V4	118	ETR542PK	124	GP4856	211
EPP4060FNR	11	ESU213072V4	118	ETR60	124	GP55653	211
EPP4060FPR1	11	ESU213084V5	119	ETR602PK	124	GP55702	211
EPP4060T200	11	ESU213664V4	118	ETR72	124	GP55703	211
EPP4060T300	11	ESU213672V4	118	FR258	70	GPE0540	206
EPPID5	8	ESU213684V5	119	FSG480	43	GPE3980	206
EPPMD4835	8	ESU214264V4	118	FSG720	43	GPE4002	206
ES28	47	ESU214272V4	118	FWC56	70	GPE4004	206
ES28RL	47	ESU214284V5	119	FWC56	78	HBR258	69
ESR14E	123	ESU214864V4	118	GB1200CW	176	HBR258	71
ESR18E	123	ESU214872V4	118	GB850CW	176	HBR414	69
ESR21E	123	ESU214884V5	119	GK2000	67	HBR578	69
ESR2436	123	ESU215464V4	118	GL0540	212	HBR712	69
ESR24363	123	ESU215472V4	118	GL1070	212	HE3	72
ESR2442	123	ESU215484V5	119	GL1070RNS	217	HFR258	70
ESR24423	123	ESU216064V4	118	GL1080	212	HK39	172
ESR2448	123	ESU216072V4	118	GL210P	213	HK39B	249
ESR24483	123	ESU216084V5	119	GL220P	213	HK93BCW	172
ESR24E	123	ESU217264V4	118	GL3074	212	HK93CW	172
ESR24S	123	ESU217272V4	118	GL3980	212	HP3253	8, 11, 17, 18, 19, 21
ESR30S	123	ESU217284V5	119	GL3980NS	216, 260	HT10CW	179
ESR36S	123	ESU242464V4	118	GL3980RNS	217	HT120CW	177, 179
ESR42S	123	ESU242472V4	118	GL4002	212	HT12CW	179
ESR48S	123	ESU242484V5	119	GL4002NS	216, 260	HT14CW	179
ESR54S	123	ESU243064V4	118	GL4002RNS	217	HT16CW	177, 179
ESR60S	123	ESU243072V4	118	GL4060	36, 212	HT22CW	177, 179
ESR72S	123	ESU243084V5	119	GL4210	212	HT5CW	179

ALPHA NUMERICAL LISTING

CODE	PAGE	CODE	PAGE	CODE	PAGE	CODE	PAGE
HT8CW	177, 179	LED54LIGHTPKG	42	MPA41117V4PKG	102	MPA51717V4PKG	102
HWAPR	34	LT10	177, 180	MPA41118V4PKG	102	MPA51718V4PKG	102
HWATD	34	LT12	177, 180	MPA41118V5PKG	103	MPA51718V5PKG	103
IB32	168	LT14	177, 180	MPA41217V4PKG	102	MPA5617V4PKG	102
IB36	168	LT16	177, 180	MPA41218V4PKG	102	MPA5618V4PKG	102
IB44	168	LT22	180	MPA41218V5PKG	103	MPA5618V5PKG	103
IBS20	168	LT6	177, 180	MPA41317V4PKG	102	MPA5717V4PKG	102
IBS27	168	LT8	177, 180	MPA41318V4PKG	102	MPA5718V4PKG	102
IBS37	168	MA2028	234	MPA41318V5PKG	103	MPA5718V5PKG	103
IBSD37	168	MA2435	234	MPA41417V4PKG	102	MPA5817V4PKG	102
IBSF27	168	MA3142H	234	MPA41418V4PKG	102	MPA5818V4PKG	102
ICS100L	60	MA3200	234	MPA41418V5PKG	103	MPA5818V5PKG	103
ICS100L4S	60	MA3343	234	MPA41517V4PKG	102	MPA5917V4PKG	102
ICS125L	60	MA3646	234	MPA41518V4PKG	102	MPA5918V4PKG	102
ICS125LB	60	MA3652TR	234	MPA41518V5PKG	103	MPA5918V5PKG	103
ICS125T	60	MA3753	234	MPA41617V4PKG	102	MPA61017V4PKG	102
ICS175L	60	MA3800	234	MPA41618V4PKG	102	MPA61018V4PKG	102
ICS175LB	60	MA4300	234	MPA41618V5PKG	103	MPA61018V5PKG	103
ICS175T	60	MA4361	234	MPA41717V4PKG	102	MPA61117V4PKG	102
ICS175TB	60	MDC1411T60	267	MPA41718V4PKG	102	MPA61118V4PKG	102
ICS200TB	60	MDC1418S20	265	MPA41718V5PKG	103	MPA61118V5PKG	103
IT3253	257	MDC1418T16	266	MPA4617V4PKG	102	MPA61217V4PKG	102
IT3753T	257	MDC1418T30	266	MPA4618V4PKG	102	MPA61218V4PKG	102
ITENEPP	255	MDC1520S10	264	MPA4618V5PKG	103	MPA61218V5PKG	103
ITENEPP1118	255	MDC1520S10D	263	MPA4717V4PKG	102	MPA61317V4PKG	102
ITENEPP1118H	255	MDC1520S10HD	264	MPA4718V4PKG	102	MPA61318V4PKG	102
ITENEPP21	255	MDC1520S20	265	MPA4718V5PKG	103	MPA61318V5PKG	103
ITENEPP21H	255	MDC1520T16	266	MPA4817V4PKG	102	MPA61417V4PKG	102
ITENEPP23	255	MDC1520T30	266	MPA4818V4PKG	102	MPA61418V4PKG	102
ITENEPP23H	255	MDC24	35	MPA4818V5PKG	103	MPA61418V5PKG	103
ITPD3253	257	MDC24F	35	MPA4917V4PKG	102	MPA61517V4PKG	102
ITPD3753T	257	MDC24R	35	MPA4918V4PKG	102	MPA61518V4PKG	102
KK1200	67	MDCPC9CW	173	MPA4918V5PKG	103	MPA61518V5PKG	103
KSC402	47	MDSB16	248	MPA51017V4PKG	102	MPA61617V4PKG	102
KVC854	46	MDSB16	255	MPA51018V4PKG	102	MPA61618V4PKG	102
KVC854C	46	MDSB5	248	MPA51018V5PKG	103	MPA61618V5PKG	103
KVC856	46	MDSB9	248	MPA51117V4PKG	102	MPA61717V4PKG	102
KVC856C	46	MDSCDB9EU24V	249	MPA51118V4PKG	102	MPA61718V4PKG	102
KWS40	47	MDSCDC9X5EU24V	244	MPA51118V5PKG	103	MPA61718V5PKG	103
LCDCH	34	MDS9	249	MPA51217V4PKG	102	MPA6617V4PKG	102
LCDCH10	34	MDSHB5	247	MPA51218V4PKG	102	MPA6618V4PKG	102
LCDES	34	MDSHB9	247	MPA51218V5PKG	103	MPA6618V5PKG	103
LD105	192	MDSHD9	247	MPA51317V4PKG	102	MPA6717V4PKG	102
LD105A	192	MDSHM8	247	MPA51318V4PKG	102	MPA6718V4PKG	102
LD130	192	MDSL9	249	MPA51318V5PKG	103	MPA6718V5PKG	103
LD85	192	MDSL9	249	MPA51417V4PKG	102	MPA6817V4PKG	102
LD85A	192	MDSM8	248	MPA51418V4PKG	102	MPA6818V4PKG	102
LDT10	177, 178	MDSP9	249	MPA51418V5PKG	103	MPA6818V5PKG	103
LDT12	177, 178	MDSPC9	249	MPA51517V4PKG	102	MPA6917V4PKG	102
LDT16	177, 148	MDSPL	248	MPA51518V4PKG	102	MPA6918V4PKG	102
LDT22	177, 148	MDSPLT9	249	MPA51518V5PKG	103	MPA6918V5PKG	103
LDT5	177, 148	MPA41017V4PKG	102	MPA51617V4PKG	102	MPCC1	105
LDT6	177, 148	MPA41018V4PKG	102	MPA51618V4PKG	102	MPCC10	105
LDT9	177, 148	MPA41018V5PKG	103	MPA51618V5PKG	103	MPCC8	105

ALPHA NUMERICAL LISTING

CODE	PAGE	CODE	PAGE	CODE	PAGE	CODE	PAGE
MPDS30H16	105	MPMU61117S4PKG	103	MPU41117V4PKG	102	MPU51717V4PKG	102
MPDS30H30	105	MPMU61117V4PKG	103	MPU41118V4PKG	102	MPU51718V4PKG	102
MPDS40H16	105	MPMU61217PDPKG	109	MPU41118V5PKG	103	MPU51718V5PKG	103
MPDS40H30	105	MPMU61217PDPKG	253	MPU41217V4PKG	102	MPU5617V4PKG	102
MPDS50H16	105	MPMU61217S4PKG	103	MPU41218V4PKG	102	MPU5618V4PKG	102
MPDS50H30	105	MPMU61217V4PKG	103	MPU41218V5PKG	103	MPU5618V5PKG	103
MPDS60H16	105	MPMU61317DRPKG	108	MPU41317V4PKG	102	MPU5717V4PKG	102
MPDS60H30	105	MPMU61317DRPKG	252	MPU41318V4PKG	102	MPU5718V4PKG	102
MPHU51017S4PKG	113	MPMU61317S4PKG	103	MPU41318V5PKG	103	MPU5718V5PKG	103
MPHU51017V4PKG	113	MPMU61317V4PKG	103	MPU41417V4PKG	102	MPU5817V4PKG	102
MPHU51117S4PKG	113	MPMU6917S4PKG	103	MPU41418V4PKG	102	MPU5818V4PKG	102
MPHU51117V4PKG	113	MPMU6917V4PKG	103	MPU41418V5PKG	103	MPU5818V5PKG	103
MPHU51217S4PKG	113	MPR1000S	107	MPU41517V4PKG	102	MPU5917V4PKG	102
MPHU51217V4PKG	113	MPR1100S	107	MPU41518V4PKG	102	MPU5918V4PKG	102
MPHU51317S4PKG	113	MPR1200S	107	MPU41518V5PKG	103	MPU5918V5PKG	103
MPHU51317V4PKG	113	MPR1300S	107	MPU41617V4PKG	102	MPU61017V4PKG	102
MPHU5917S4PKG	113	MPR1400S	107	MPU41618V4PKG	102	MPU61018V4PKG	102
MPHU5917V4PKG	113	MPR1500S	107	MPU41618V5PKG	103	MPU61018V5PKG	103
MPHU61017S4PKG	113	MPR1600S	107	MPU41717V4PKG	102	MPU61117V4PKG	102
MPHU61017V4PKG	113	MPR1700S	107	MPU41718V4PKG	102	MPU61118V4PKG	102
MPHU61117S4PKG	113	MPR300E	107	MPU41718V5PKG	103	MPU61118V5PKG	103
MPHU61117V4PKG	113	MPR400E	107	MPU4617V4PKG	102	MPU61217V4PKG	102
MPHU61217S4PKG	113	MPR500E	107	MPU4618V4PKG	102	MPU61218V4PKG	102
MPHU61217V4PKG	113	MPR6001000	107	MPU4618V5PKG	103	MPU61218V5PKG	103
MPHU61317S4PKG	113	MPR60010003	107	MPU4717V4PKG	102	MPU61317V4PKG	102
MPHU61317V4PKG	113	MPR6001100	107	MPU4718V4PKG	102	MPU61318V4PKG	102
MPHU6917S4PKG	113	MPR60011003	107	MPU4718V5PKG	103	MPU61318V5PKG	103
MPHU6917V4PKG	113	MPR600900	107	MPU4817V4PKG	102	MPU61417V4PKG	102
MPMCHD	113	MPR6009003	107	MPU4818V4PKG	102	MPU61418V4PKG	102
MPMCWB	106	MPR600E	107	MPU4818V5PKG	103	MPU61418V5PKG	103
MPMU41017S4PKG	103	MPR600S	107	MPU4917V4PKG	102	MPU61517V4PKG	102
MPMU41017V4PKG	103	MPR700S	107	MPU4918V4PKG	102	MPU61518V4PKG	102
MPMU41117S4PKG	103	MPR800S	107	MPU4918V5PKG	103	MPU61518V5PKG	103
MPMU41117V4PKG	103	MPR900S	107	MPU51017V4PKG	102	MPU61617V4PKG	102
MPMU41217S4PKG	103	MPTR100	108	MPU51018V4PKG	102	MPU61618V4PKG	102
MPMU41217V4PKG	103	MPTR1002PK	108	MPU51018V5PKG	103	MPU61618V5PKG	103
MPMU41317S4PKG	103	MPTR110	108	MPU51117V4PKG	102	MPU61717V4PKG	102
MPMU41317V4PKG	103	MPTR1102PK	108	MPU51118V4PKG	102	MPU61718V4PKG	102
MPMU4917S4PKG	103	MPTR120	108	MPU51118V5PKG	103	MPU61718V5PKG	103
MPMU4917V4PKG	103	MPTR1202PK	108	MPU51217V4PKG	102	MPU6617V4PKG	102
MPMU51017S4PKG	103	MPTR130	108	MPU51218V4PKG	102	MPU6618V4PKG	102
MPMU51017V4PKG	103	MPTR1302PK	108	MPU51218V5PKG	103	MPU6618V5PKG	103
MPMU51117S4PKG	103	MPTR140	108	MPU51317V4PKG	102	MPU6717V4PKG	102
MPMU51117V4PKG	103	MPTR150	108	MPU51318V4PKG	102	MPU6718V4PKG	102
MPMU51217S4PKG	103	MPTR160	108	MPU51318V5PKG	103	MPU6718V5PKG	103
MPMU51217V4PKG	103	MPTR170	108	MPU51417V4PKG	102	MPU6817V4PKG	102
MPMU51317S4PKG	103	MPTR60	108	MPU51418V4PKG	102	MPU6818V4PKG	102
MPMU51317V4PKG	103	MPTR70	108	MPU51418V5PKG	103	MPU6818V5PKG	103
MPMU5917S4PKG	103	MPTR80	108	MPU51517V4PKG	102	MPU6917V4PKG	102
MPMU5917V4PKG	103	MPTR90	108	MPU51518V4PKG	102	MPU6918V4PKG	102
MPMU61017S4PKG	103	MPTR902PK	108	MPU51518V5PKG	103	MPU6918V5PKG	103
MPMU61017V4PKG	103	MPU41017V4PKG	102	MPU51617V4PKG	102	MW2129	228
MPMU61117DRPKG	108	MPU41018V4PKG	102	MPU51618V4PKG	102	MW3200	228
MPMU61117DRPKG	252	MPU41018V5PKG	103	MPU51618V5PKG	103	MW3245	228

ALPHA NUMERICAL LISTING

CODE	PAGE	CODE	PAGE	CODE	PAGE	CODE	PAGE
MW3600	228	PCUPC2	29	PT1600	227	RSB15CW	189
MW3646	228	PCUPH	29	PWB22	34, 183	RSB18CW	189
MW3858	228	PCUPH2	29	R100LCD	34	RSB23CW	189
MW4200	228	PCUPP	31	R500LCD	34	RSB6CW	189
MY2026	231	PE600CW	175	RD1200CW	191	RSB8CW	189
MY2129	231	PH556010	229	RD1220CW	191	RSB912CW	189
MY2632	231	PH556016	229	RD1220CWH	191	SB55	190
MY2738	231	PH556020	229	RD1826CW	191	SB60	190
MY3200	231	PH556026	229	RD1826CWH	191	SB80	190
MY3244	231	PH556030	229	RD926CW	191	SBH15	42
MY3253	231	PH556036	229	RFS1	147	SBH18	42
MY3343	231	PH556040	229	RFS12	147	SCP12CW	169
MY3446	231	PH556046	229	RFS12PP	147	SCP24CW	169
MY3646	231	PH556050	229	RFS12SCPP	146	SCP64CW	169
MY3753	231	PH556056	229	RFS18	147	SCP6CW	169
MY3800	231	PH556510	229	RFS18PP	147	SFC12	143
MY3952	231	PH556516	229	RFS1PP	147	SFC12SCPP	142
MY4300	231	PH556520	229	RFS1SCPP	146	SFC2	143
MY4361	231	PH556526	229	RFS2	147	SFC2SCPP	142
NT10	177, 179	PH557010	229	RFS22	147	SFC6	143
NT12	177, 179	PH557016	229	RFS22PP	147	SFC6SCPP	142
NT14	179	PH557020	229	RFS2PP	147	SFG1012	187
NT16	179	PH557026	229	RFS2SCPP	146	SFG1015	187
NT20	177, 179	PH557030	229	RFS4	147	SFG1220	187
NT5	177, 179	PH557036	229	RFS4PP	147	SFG820	187
NT8	177, 179	PH557040	229	RFS6	147	SFR1012	187
NT9	177, 179	PH557046	229	RFS6PP	147	SFT1010	187
OETR314	70	PH558510	229	RFS6SCPP	146	SFT1212	187
P320CW	175	PH558516	229	RFS8	147	SFT1515	187
P34CW	175	PH558520	229	RFS8PP	147	SFV1015	187
P34LCW	175	PH558526	229	RFSC1	147	SLL30	166
P480CW	175	PH558530	229	RFSC12	147, 183	SPA14	193
P600CW	175	PH558536	229	RFSC12PP	147	SPASL14	193
P60CW	175	PL60CW	175	RFSC1PP	147	SPO10CW	193
P64CW	175	PPB15	184	RFSC2	147	SPO11CW	193
PC34CW	175	PPB18	184	RFSC2PP	147	SPO13	193
PC64CW	175	PPB23	184	RFSC6	147	SPO13CW	193
PCMC	29	PR314	70	RFSC6PP	147	SPO8CW	193
PCMH	29	PR500	70, 250	RFSCW1	146	SPOP10CW	193
PCMH2	29	PR59314	70	RFSCW12	146	SPOP11CW	193
PCUCC	29	PR59500	70	RFSCW18	146	SPOP13	193
PCUCC2	29	PS1014	236	RFSCW2	146	SPOP13CW	193
PCUCH	29	PSB10	188	RFSCW22	146	SRB13	183
PCUCH2	29	PSB12	188	RFSCW4	146	SRB13CW	183
PCUHC	29	PSB15	189	RFSCW6	146	SRB5	183
PCUHC2	29	PSB18	189	RFSCW8	146	SRB5CW	183
PCUHH	29	PSB23	189	RFSCWC1	146	SSR1	29, 31
PCUHH2	29	PSB6	188	RFSCWC12	146	SSR8	29, 31
PCULC	29	PSB8	188	RFSCWC2	146	TC1418	78
PCULC2	29	PT1014	227	RFSCWC6	146	TDC2029	78
PCULH	29	PT1100	227	RSB1014CW	189	TDC30	83
PCULH2	29	PT1216	227	RSB10CW	189	TDCR12	78
PCULP	31	PT1400	227	RSB12CW	189	TG6	194
PCUPC	29	PT1418	227	RSB1419CW	189	TG9	194

ALPHA NUMERICAL LISTING

CODE	PAGE	CODE	PAGE	CODE	PAGE	CODE	PAGE
TGA11	194	UPCHT1600	24	VBRTL6	41	VL3646CNS	216, 260
TGA8	194	UPCHT16002	24	VBRTLHD5	41	VL3753	213
TGG6	194	UPCHT16002HD	24	VBRTLHD6	41	VT1216	210
TGG9	194	UPCHT1600HD	24	VBRU5	41	VT1418	207, 210, 215
UC1000	33	UPCHT800	24	VBRU6	41	VT1418AB	208, 258
UC1000CVR	33	UPCHT8002	24	VBRUHD5	41	VT1418TR	210
UC250	33	UPCHW400	24	VBRUHD6	41	VT1520	210
UC250CVR	33	UPCHW4002	24	VBRUT5	41	VT2632	207, 210
UC500	33	UPCS140	13	VBRUT6	41	VT3253	207, 210
UC500CVR	33	UPCS160	13	VBRUTHD5	41	VT3343	207, 210
UPC100	13	UPCS180	13	VBRUTHD6	41	VT3343AB	208, 258
UPC1200	21	UPCS400	19	VBRWC	42	VT3343C	210, 215
UPC140	13	UPCS400CK	19	VCS	41	VT3343CAB	208, 258
UPC160	13	VBR5	41	VCS32CNT	41	VT3646C	207, 210, 215
UPC1600	21	VBR6	41	VCS32KEYT	42	VT3646CAB	208, 258
UPC1600HD	21	VBRC	41	VCS32R	42	VT3753	207, 210
UPC1600SP	21	VBRC90	41	VCSCNL	41	VT3853	210
UPC180	13	VBRCVR5	42	VCSCVR	42	VTE1418	206
UPC300	17	VBRCVR6	42	VCSHD	41	VTE3253	206
UPC300DIV	14	VBRHD5	41	VCSWR	41	VTE3343	206
UPC400	18	VBRHD6	41	VCSWRHD	41	VTE3646C	206
UPC400SP	18	VBRL5	41	VL1014	213	VTE3753	206
UPC600	21	VBRL6	41	VL1216	213	WC100CW	184
UPC800	21	VBRLHD5	41	VL1418	213, 215	WC100CWNH	184
UPC800SP	21	VBRLHD6	41	VL1418NS	216, 260	WCR1220	46, 49
UPCGL1600SP	21	VBRR5	42	VL1418RNS	217	WR60406	36
UPCH1600	24	VBRR6	42	VL2129RNS	217	WR60407	36
UPCH16002	24	VBRSHTS	42	VL2632	213	WW1000	182
UPCH16002HD	24	VBRT5	41	VL3200RNS	217	WW1000L	182
UPCH16002SP	24	VBRT6	41	VL3253	213	WW1000LS	182
UPCH1600HD	24	VBRTBL	42	VL3343	213	WW1500	182
UPCH1600SP	24	VBRTCVR5	42	VL3343C	213, 215	WW250	182
UPCH400	24	VBRTCVR6	42	VL3343CNS	216, 260	WW250L	182
UPCH4002	24	VBRTHD5	41	VL3343NS	216, 260	WW500	182
UPCH800	24	VBRTHD6	41	VL3600RNS	217		
UPCH8002	24	VBRTL5	41	VL3646C	213, 215		

Cambro® Warranty

Cambro Camtrays® and Camwear® Dinnerware have a five year guarantee against breakage. Camtherm Bulk Food Holding Cabinets hold a one-year warranty. Camwear food storage products are guaranteed for two years under normal usage. Camshelving® has a one-year warranty on workmanship and a lifetime limited warranty against rust and corrosion, excluding mobile posts. For all other Cambro products, Cambro warrants to the original buyer a three-year pro-rated guarantee. If product proves defective during this time, Cambro grants a pro-rated credit of the original price toward replacement product. The warranty applies on all Cambro products only when used under normal foodservice industry conditions.

Photo credits:

Cambro products help foodservice operators throughout the world. To represent our global presence, images of Cambro products in use have been taken on locations throughout southern California, USA; in Cancun, Mexico; on the island of Rugen, Germany; and in the city of Huizhou, China. In particular, special thanks to the staffs of the Ambience Hotel, Rugen; Jin Hua Palace Hotel, Huizhou; Southern California Gas Company, Downey; Orange Coast College, Santa Ana and California Hospital, Los Angeles for their assistance in our photo shoots.

STEMWARE AND GLASS SIZING REFERENCE GUIDE

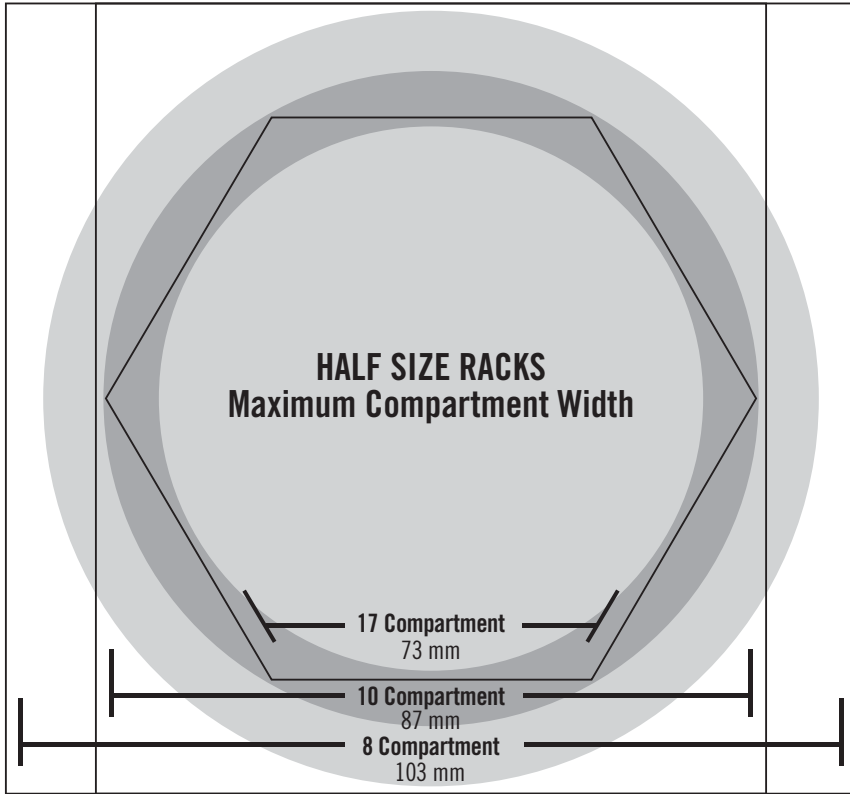

To Determine Compartment Size

• **Half Size Racks:**

Place glass or stemware upside down over circle chart. Look down on the glass. Whatever circle the largest diameter of the glass fits within will determine the number of compartments.

• **Full Size Racks:**

Place glass or stemware upside down over circle chart. Look down on the glass. Whatever circle the largest diameter of the glass fits within will determine the number of compartments.

Use the vertical guide marks at right to determine item height and appropriate rack number.

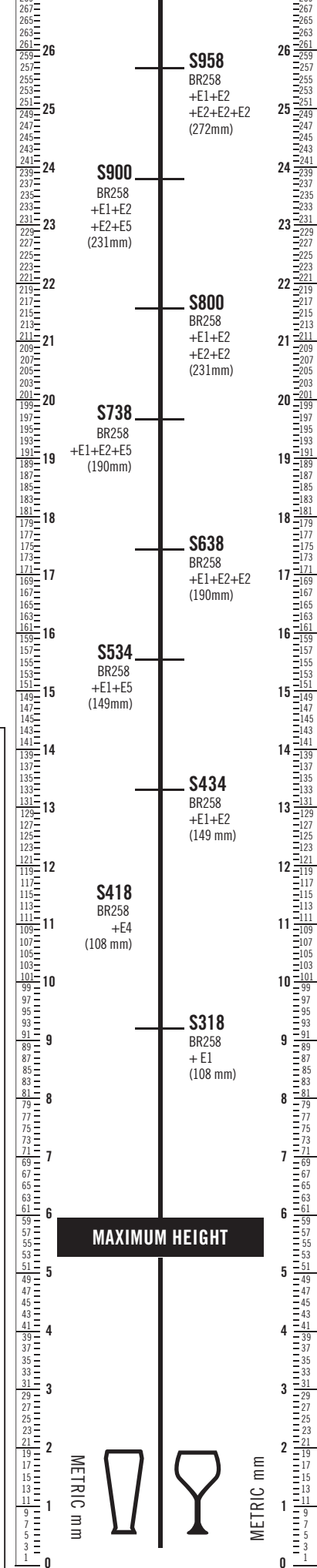
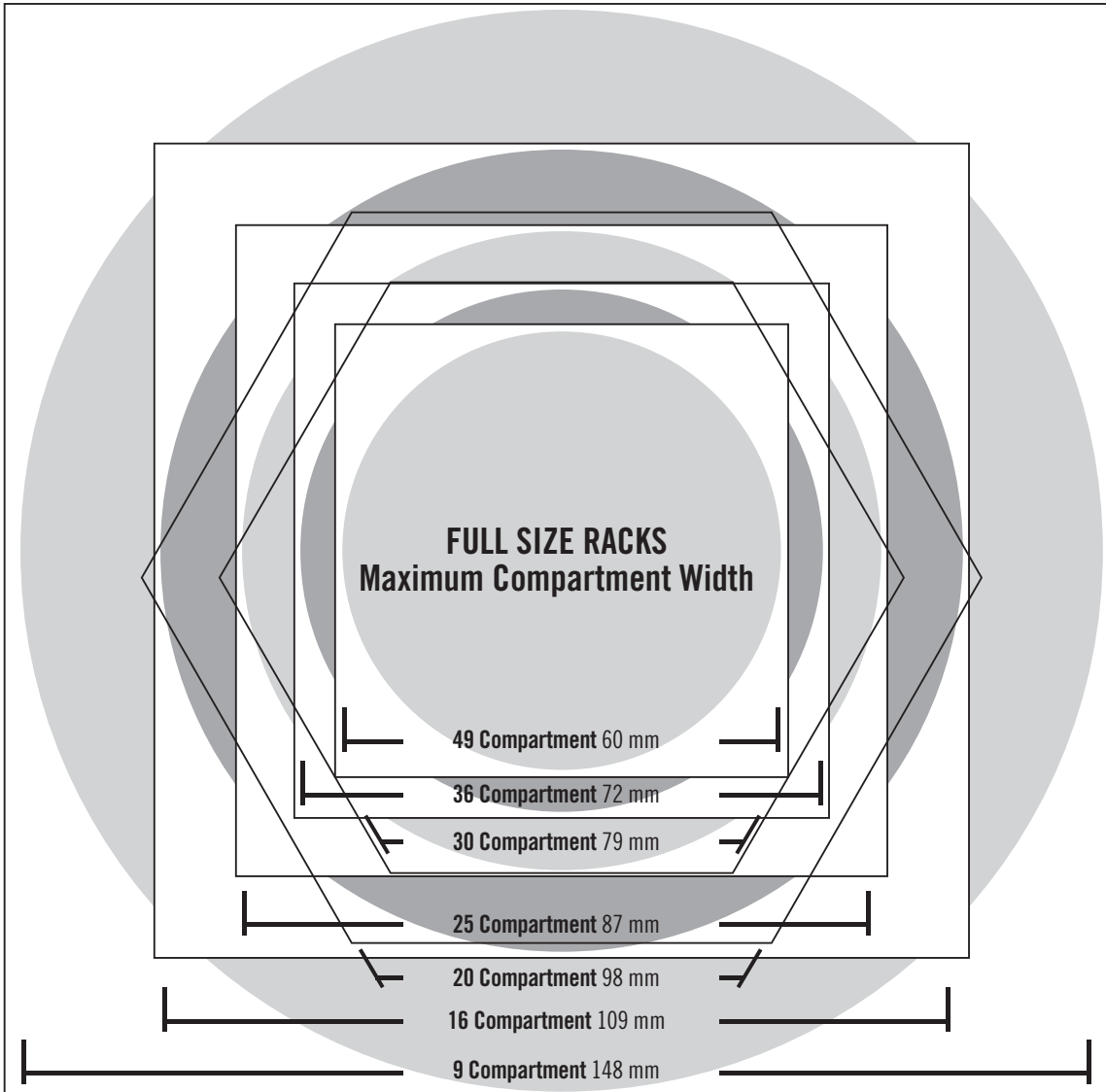

CAMRACK® CUP RACK REFERENCE GUIDE

↖

16

FULL RACK

COMPARTMENT
11,1 x 11,1 cm

QUICK GUIDE

Full Size Cup Racks (C)

Maximum Cup Width	Number of Compartments	Maximum Cup Height		
		6,6 cm	10,7 cm	14,9 cm
11,1 cm	16	16C258	16C414	16C578
8,8 cm	20	20C258	20C414	20C578

To determine Cup compartment size:

Turn cup or coffee mug upside down and place diagonally in square. Align handle with arrow in square. Cup or mug and handle must fit completely within boundaries of a square in order to ensure the right rack.

↗

20

FULL RACK

COMPARTMENT
11,1 x 8 cm

↖

10

HALF RACK

COMPARTMENT
10,4 x 8,8 cm

↗

8

HALF RACK

COMPARTMENT
11,3 x 10,4 cm

QUICK GUIDE

Full Size Cup Racks (C)

Maximum Cup Width	Number of Compartments	Maximum Cup Height	
		6,6 cm	10,7 cm
10,4 cm	8	8HC258	8HC414
8,8 cm	10	10HC258	10C414

To Determine Cup Height:

Place base of cup or coffee mug on flat surface hold ruler vertically next to it to determine height in inches or millimeters. If the height is greater than 108 mm, additional 41 mm E2 and HE2 extenders may be ordered.

CAMBRO® EQUIPMENT COLOR CHART



180
Gray



157
Coffee Beige



158
Hot Red

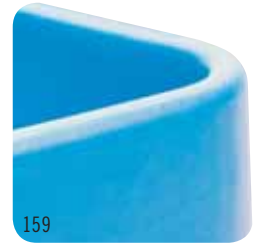

159
Cold Blue

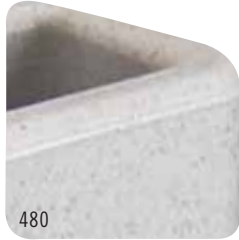

480
Speckled Gray



417
Dark Taupe



402
Brick Red



186
Navy Blue



191
Granite Gray



194
Granite Sand

Cambro provides a wide selection of colors to help you coordinate with your decor and color code items to simplify use. Color selections vary by product. Please see individual products for specific colors offered.



401
Slate Blue

Due to the printing process, the colors shown may not be exact. For exact colors, contact Cambro or a Cambro Sales Representative for a color chip.



615
Charcoal Gray



131
Dark Brown

Due to the catalog printing process, the colors shown may not be exact. For exact colors, contact Cambro or a Cambro representative for a color chip.



192
Granite Green



110
Black



519
Kentucky Green

NEW FROM CAMBRO®



Cam GoBox® Lunch Box **8**
Cam GoBox4060 Insulated Carriers **10**



UPC300 Ultra Pan Carrier® **17**



Pro Cart Ultra™ **25**



1318CC Combo Carrier **37**



Camshelving® Flex Station **50**



Shelf Rails **107, 123**
Camshelving Basics Plus **126**



15 cm Depth GN 1/9 Camwear® and
High Heat Food Pan **153, 159**



Gastronorm High Heat X-pan® **156**



H-pan™ with Handles **162**



Polypropylene Colander Pans **163**



Soak & Brine Tank **168**



Camwear Low Profile Camcover® **173**



EpicTread™ Trays **228**



Madeira Trays **234**



Camduction® Complete Heat System **244**



Harbor Collection Meal Delivery System **247**



Camchiller® Pellet **249**



Tablotherm Cam GoBox **254**



Camwear Non-Skid Tray
with Handles **262**



10-Tray Dual Access Room Service Cart **263**
Airpot and Condiment Station **264**

CAMBRO
TRUSTED FOR GENERATIONS™

CAMBRO U.S.A.
5801 Skylab Road, Huntington Beach, CA 92647
P.O. Box 2000, Huntington Beach, CA 92647-2000
TEL: 1(714) 848-1555 FAX: 1(714) 843-2630
international@cambro.com

C.E.L.
TEL: (49) 7022 90 100 0
FAX: (49) 7022 90100 19
cambroeuropa@cambro.com

CAMBRO UK
TEL: 0800 587 0057 Toll Free
FAX: 0845 280 3411
cambrouk@cambro.com

IRELAND
TEL: 1800 509 046 Toll Free
FAX: 01 633 55 76
cambroireland@cambro.com

© Copyright Cambro Manufacturing Company. Printed in the U.S.A.

CAT2018/19MTEUR

ISO 9001:2008
CERTIFIED



Cambro is a proud recipient of the U.S. President's E-Award for Excellence in Exporting.